

THEME: Environment (including climate change)
 TOPIC: ENV.2011.2.1.2-1 Hydromorphology and ecological objectives of WFD
 Collaborative project (large-scale integrating project)
 Grant Agreement 282656
 Duration: November 1, 2011 – October 31, 2015



Deliverable D7.5 Proceedings of the final conference
 Title Proceedings of the International Conference on River and Stream Restoration "Novel Approaches to Assess and Rehabilitate Modified Rivers"
 Author(s) Natalie Angelopoulos (UHULL), Tom Buijse (Deltares), Mijke van Oorschot (Deltares), Eleftheria Kampa (Ecologic)

Due date to deliverable: 31 August 2015
 Actual submission date: 27 August 2015

Project funded by the European Commission within the 7th Framework Programme (2007 – 2013)
 Dissemination Level

PU Public X
 PP Restricted to other programme participants (including the Commission Services)
 RE Restricted to a group specified by the consortium (including the Commission Services)
 CO Confidential, only for members of the consortium (including the Commission Services)

Summary

This deliverable forms the proceedings of the International Conference 'Novel Approaches to Assess and Rehabilitate Modified Rivers', which took place from 30th June to 2nd July 2015 in Wageningen (the Netherlands).

The much appreciated and successful scientific conference was organized to highlight the importance of the benefits of river restoration. 170 participants from 26 countries shared experiences, aspirations, challenges, analytical frameworks and new approaches to enhance the success of river restoration and to come to a better understanding of the consequences of hydro-morphological changes to the ecological status of running waters. The conference attracted universities and research institutes, environmental management organisations, NGOs and consulting firms in the field of river restoration. 15 keynote lectures from Europe, North America and New Zealand, 58 oral presentations in breakout sessions and 38 posters provided the ingredients and inspiration for animated conversations during the breaks.

Among others, evidence outlined by the conference speakers and participants gave fundamental insights into how rivers work, and presented a wide span of research from global to catchment and all the way down to the species level. It became evident that attention is shifting towards reflecting on the river in its full scope including the role of the riparian zone and the floodplain for ecosystem functioning. Keynote and oral presentations made a case for the need to develop more process-oriented restoration measures, and to consider hydromorphological changes and their evolution both in terms of space and time. A lot of inspiration for further work was given by presentations on the application of biotic indices for the assessment of river ecological conditions as well as by a multitude of case studies presented on the achievements by restoration and mitigation practices in Europe and beyond. The conference also provided a platform for exchanging experiences and ongoing work on the challenging issues of socioeconomic assessments related to river restoration, tools and strategies for more closely linking science to the practitioner level.

These proceedings contain the extended summaries of nearly all keynotes and oral presentations as well as several poster presentations. They are preceded by a description of the scope, objectives and topics of the conference, feedback from the advisory and a visual impression of conference. The contributions are grouped within the six conference topics:

- I. Assessment and rehabilitation of hydromorphological processes in rivers
- II. Discerning the impact of hydromorphological modification from other stressors
- III. Achievements by restoration and mitigation practices
- IV. How to improve the (cost-)effectiveness of river rehabilitation?
- V. Benefits of river rehabilitation and synergies with other uses (flood protection, navigation, agriculture, hydropower)
- VI. Linking science to practice: tools to assess river status and guide rehabilitation to optimize river basin management

To be cited as:

Angelopoulos, N., T. Buijse, M. van Oorschot & E. Kampa [eds.] (2015) Proceedings of the International Conference on River and Stream Restoration "Novel Approaches to Assess and Rehabilitate Modified Rivers". FP7 REFORM deliverable 7.5. 417 p.

Individual contributions to be cited as:

Brierley, G. (2015) Linking science to practice: tools to assess river status and guide rehabilitation to optimize river basin management. In: Angelopoulos, N., T. Buijse et al. [eds.] Proceedings of the International Conference on River and Stream Restoration "Novel Approaches to Assess and Rehabilitate Modified Rivers". FP7 REFORM deliverable 7.5. p 21 - 27

Acknowledgements

REFORM receives funding from the European Union's Seventh Programme for research, technological development and demonstration under Grant Agreement No. 282656.

Contents

CONTENTS	IV
1. SCOPE, OBJECTIVES AND TOPICS	10
CONFERENCE SCOPE AND OBJECTIVES	10
CONFERENCE TOPICS	10
IMPRESSION OF THE REFORM CONFERENCE	12
2. ADVISORY BOARD FEEDBACK ON REFORM'S FINAL CONFERENCE	17
3. KEYNOTES	19
LINKING SCIENCE TO PRACTICE: TOOLS TO ASSESS RIVER STATUS AND GUIDE REHABILITATION TO OPTIMIZE RIVER BASIN MANAGEMENT <i>Brierley G</i>	20
THE SOCIO-ECONOMIC BENEFITS OF RIVER RESTORATION <i>Brouwer R et al</i>	27
REFORM: SCIENTIFIC PROGRESS AND TOOLS FOR WATER MANAGEMENT <i>Buijse T et al.</i>	32
MEASURING RESTORATION SUCCESS <i>Cowx I G & Angelopoulos N</i>	37
BETWEEN A ROCK AND A HARD PLACE: ECOLOGICAL RESPONSES TO DEGRADED HYDROMORPHOLOGY IN RIVERS <i>Friberg N et al.</i>	43
ANTICIPATING FUTURE TRAJECTORIES OF FLOODPLAIN RIVERS AND HUMAN SYSTEMS IN RIVER RESTORATION <i>Gregory S</i>	48
HYDROMORPHOLOGY-VEGETATION INTERACTIONS ALONG RIVER CORRIDORS: A CONCEPTUAL FRAMEWORK <i>Gurnell A et al.</i>	54
CONTRASTING THE ROLES OF SECTION LENGTH AND INSTREAM HABITAT ENHANCEMENT FOR RIVER RESTORATION SUCCESS: A FIELD STUDY ON 20 EUROPEAN RESTORATION PROJECTS <i>Hering D</i>	58
THE ECONOMIC VALUE OF RESTORATION BASED ON THE ECOSYSTEM SERVICES APPROACH <i>Koundouri P & Souliotis I</i>	63
IMPROVING RIVER RESTORATION POLICY: A FEW DISCUSSION POINTS FOLLOWING 10 TO 20 YEARS OF ACTIONS <i>Piegay H et al</i>	67
GAPS AND POSSIBLE WAYS FORWARD FOR RIVER RESTORATION <i>Pollard P</i>	71

KEY CONSIDERATIONS FOR MEASURING RIVER RESTORATION SUCCESS: LESSONS FROM WESTERN NORTH AMERICA	73
<i>Roni P</i>	
HYDROMORPHIC CHANGE AND BIOTIC RESPONSE CHALLENGE EFFICIENT RIVER REHABILITATION	79
<i>Wolter C et al.</i>	
4. ASSESSMENT AND REHABILITATION OF HYDROMORPHOLOGICAL PROCESSES IN RIVERS	85
DEVELOPMENT OF A SYSTEM FOR THE CLASSIFICATION OF GEOMORPHIC UNITS AIMED AT CHARACTERIZING PHYSICAL HABITATS AND STREAM MORPHOLOGY	86
<i>Belletti B et al.</i>	
SEDIMENT IS NOT A PROBLEM	92
<i>Detering M & Bartelt D</i>	
REACH SCALE FLOODPLAIN RECONNECTION AND RESTORATION: ACHIEVING THE OBJECTIVES OF THE COLUMBIA RIVER BIOP	98
<i>Drury T, Gaffney J & Fisher B</i>	
TORRENT RESTORATIONS IN THE FLYSCH MID-MOUNTAIN ENVIRONMENT: THE CASE STUDY OF THE KNĚŽYŇ TORRENT, CZECH REPUBLIC	104
<i>Galia T, Škarpich V & Hradecký J</i>	
TOWARDS A MORE COMPREHENSIVE ASSESSMENT OF RIVER ECOLOGICAL CONDITIONS: APPLICATION OF A NEW DRAGONFLY-BASED INDEX IN NORTHERN ITALY	109
<i>Golfieri B et al.</i>	
APPLYING PROCESS-BASED HYDROMORPHOLOGICAL ASSESSMENT TO THE IDENTIFICATION OF FINE SEDIMENT PRESSURES AND IMPACTS IN A LOWLAND AGRICULTURAL CATCHMENT	116
<i>Grabowski R C & Gurnell A M</i>	
THE HYDROMORPHOLOGICAL EVALUATION TOOL	121
<i>Habersack H & Klösch M</i>	
EXPLORING SPATIAL SCALES OF GEOMORPHICAL FEATURES DRIVING MACROINVERTEBRATE COMMUNITIES (DUERO BASIN, NW SPAIN)	127
<i>Moreno-García P et al.</i>	
DISTINCT PATTERNS OF INTERACTIONS BETWEEN VEGETATION AND RIVER MORPHOLOGY	133
<i>Van Oorschot M et al.</i>	
ASSESSING THE EFFECT OF A CATCHMENT-SCALE RESTORATION PROJECT IN WALLONIA (BELGIUM)	137
<i>Peeters A et al.</i>	
APPLICATION OF THE MORPHOLOGICAL QUALITY INDEX (MQI) TO EUROPEAN CASE STUDIES	143
<i>Nardi L et al.</i>	
PROCESS BASED CLASSIFICATION OF SEDIMENT CONNECTIVITY AT THE RIVER BASIN SCALE	150
<i>Schmitt R, Bizzi S & Castelletti A</i>	
RESTORATION OF A RIVER SYSTEM IN AN URBAN AREA: TOWARDS THE GOOD ECOLOGICAL POTENTIAL OF FORMER SEWAGE CHANNELS	156

Winking C, Lorenz A & Hering D

5. DISCERNING THE IMPACT OF HYDROMORPHOLOGICAL MODIFICATION FROM OTHER STRESSORS	163
RIPARIAN PLANT COMMUNITY RESPONSES TO INCREASED FLOODING <i>Garssen A G et al.</i>	164
CHANGING E-FLOWS RESULTING FROM LAND USE CHANGE AND ALTERED GROUNDWATER CONDITIONS IN THE REGGE CATCHMENT, THE NETHERLANDS <i>Hendriks D et al.</i>	170
DIATOMS AS INDICATORS OF FINE SEDIMENT STRESS <i>Jones J I et al.</i>	176
MULTIPLE HYDROMORPHOLOGICAL STRESSORS AND THEIR IMPACT ON FISH POPULATIONS AND RIPARIAN AND FLOODPLAIN VEGETATION IN THE FORELAND OF ALPINE REGIONS <i>Kraml J et al.</i>	182
CAN MACROINVERTEBRATE BIOLOGICAL TRAITS BE USED TO INDICATE THE QUANTITY OF FINE-GRAINED SEDIMENT CONDITIONS IN STREAM BEDS? <i>Murphy J F et al.</i>	188
MECHANISTIC MODELS CAN HELP TO DISENTANGLE EFFECTS OF DIFFERENT STRESSORS ON THE MACROINVERTEBRATE COMMUNITY IN STREAMS <i>Schuwirth N et al.</i>	194
DISENTANGLING STRESSORS IN BOREAL RIVERS: DIFFUSE POLLUTION OVERRULES CHANNEL ALTERATION IN DEGRADING RIVER ASSEMBLAGES <i>Turunen J et al.</i>	198
MORPHOLOGY REVISITED; AN ECOLOGISTS VIEW ON MORPHOLOGY <i>Verdonschot P</i>	203
STREAMBED MICROHABITAT HETEROGENEITY AS A DETERMINANT OF MACROINVERTEBRATE POPULATION DEVELOPMENT <i>Verdonschot R. C. M. & Verdonschot P. F. M.</i>	208
6. ACHIEVEMENTS BY RESTORATION AND MITIGATION PRACTICES	214
EFFECTIVENESS OF GROUP OF PILE DIKES FOR FISH HABITAT <i>Aoki M et al</i>	216
FLOW RESTORATION OF THE DURANCE RIVER: IMPLEMENTATION AND MONITORING OF TARGETED WATER RELEASES TO REDUCE CLOGGING AND IMPROVE RIVER FUNCTION <i>Beche L et al.</i>	221
ECOLOGICAL ASPECTS OF FLUVIAL PROCESSES RECOVERY AT BECVA RIVER <i>Brabec K et al.</i>	228
WOODY DEBRIS INCREASES MACROINVERTEBRATES COMMUNITIES IN STREAM CONSTRUCTION WORKS <i>Brugmans et al.</i>	232
DAMS REMOVAL IN THE SELUNE RIVER (FRANCE): A LONG-TERM SCIENTIFIC AND INTERDISCIPLINARY PROGRAM <i>Fraisse S, Roussel J & Bagliniere J</i>	238

THE RESPONSE OF HYDROPHYTE GROWTH FORMS AND PLANT STRATEGIES TO RIVER RESTORATION	242
<i>Ecke F et al.</i>	
THE EFFECT OF RIVER RESTORATION ON FISH, MACROINVERTEBRATES AND AQUATIC MACROPHYTES: A META-ANALYSIS	247
<i>Kail J et al.</i>	
EFFECTS OF RIVER RESTORATION ON ¹³ C AND ¹⁵ N ISOTOPE COMPOSITION IN RIVER AND FLOODPLAIN FOOD WEBS - AN APPROACH ON 20 EUROPEAN RESTORATION PROJECTS	252
<i>Kupilas B et al.</i>	
THE INTRODUCTION OF LARGE WOOD TO IMPROVE BIODIVERSITY IN A MODIFIED NAVIGABLE RIVER STRETCH OF THE DUTCH RHINE	258
<i>Liefveld W M et al.</i>	
MANAGEMENT OF A MEANDER CUTOFF USING INSTREAM WORKS TO REDUCE THE HYDRAULIC GRADIENT	264
<i>Morris S & Broderick T</i>	
QUANTIFYING AND VALUING RIVER RESTORATION EFFECTS: THUR AND TÖSS RIVERS	268
<i>Paillex A et al</i>	
HELOPHYTES ARE EFFICIENT INDICATORS OF RIVER RESTORATION SUCCESS	272
<i>Scheunig S. D. et al.</i>	
EFFECTS OF HYDROMORPHOLOGICAL STREAM RESTORATION MEASURES ON STREAM AND RIPARIAN ZONE PLANT DIVERSITY	277
<i>Fraaije R. G. A. et al.</i>	
EVALUATION OF RESTORATION SUCCESS IN THE DANUBE DELTA USING FISH ASSEMBLAGES	279
<i>Nastase A & Staras M</i>	
7. HOW TO IMPROVE THE (COST-) EFFECTIVENESS OF RIVER REHABILITATION?	285
THE ELMO TOOLBOX: ECOLOGICAL MODELLING FOR DECISION SUPPORT IN RIVER RESTORATION PLANNING	286
<i>Bennetsen E et al.</i>	
RESTORATION SUCCESS AND FAILURE: LEARNING FROM AN INTEGRATED RESTORATION PROGRAMME IN A TEMPORARY MEDITERRANEAN RIVER SYSTEM	292
<i>Cortes R. M. V. et al.</i>	
EVALUATING THE ENVIRONMENTAL COSTS OF FLOW REGULATION: A DYNAMIC WATER PRICING APPROACH	297
<i>Garcia De Jalon S et al.</i>	
REPORTING AND PREDICTING COSTS OF RIVER RESTORATION PROJECTS	303
<i>Gerdes H, Lago M & Hinzmann M</i>	
THE ECONOMICS OF RIVER RESTORATION: EXPERIENCES THROUGHOUT EUROPE IN UNDERSTANDING EFFECTS, COSTS, AND BENEFITS OF RIVER RESTORATION PROJECTS	311
<i>Lago M et al.</i>	
RESTORATION OF NAREW NATIONAL PARK BUFFER ZONE IN CONTEXT OF ECOSYSTEM SERVICES	320
<i>Tylec L et al.</i>	

8. BENEFITS OF RIVER REHABILITATION AND SYNERGIES WITH OTHER USES (FLOOD PROTECTION, NAVIGATION, AGRICULTURE, HYDROPOWER) 325

USING HYDROSCAPES TO MAXIMIZE THE BENEFITS OF RIPARIAN CORRIDOR RESTORATION FOR MULTIPLE RIVER ECOSYSTEM SERVICES <i>Barquin J et al.</i>	326
TOWARDS A PARADIGM CHANGE IN AGRI-ENVIRONMENTAL GOVERNANCE: THE CONCEPT AND PRACTISE OF LOCALLY DRIVEN ENVIRONMENTAL INITIATIVES <i>Granholm K & Ovaska U</i>	332
INTEGRATED EVALUATION TO SUPPORT RIVER RESTORATION: A SIMPLE, BUT EFFECTIVE DECISION MAKING FRAMEWORK APPLIED TO THE CHIESE RIVER (ITALY). <i>Nardini A & Pavan S</i>	337
STRATEGIC RIVER MANAGEMENT IN STYRIA/AUSTRIA - ESTABLISHING TRADE-OFFS BETWEEN HYDROPOWER EXPANSION AND RIVER REHABILITATION <i>Raderbauer H et al.</i>	344
A QUALITATIVE CROSS-IMPACT BALANCE ANALYSIS OF THE HYDROLOGICAL IMPACTS OF LAND USE CHANGE ON CHANNEL MORPHOLOGY AND THE PROVISION OF STREAM CHANNEL SERVICES <i>Slawson D</i>	350
SOCIAL AND ECONOMIC PERSPECTIVES OF RIVER RESTORATION <i>Sterk M & Bekhuis J</i>	355
THE REVISED WATER PROTECTION LAW OF SWITZERLAND AND ITS IMPLEMENTATION TO PRACTICE <i>Thomas G</i>	360
LOWER DANUBE 4D RECONNECTION – STRATEGIC FRAMEWORK FOR LU/CLIMATE CHANGE ADAPTATION <i>Nichersu I, Staras M & Feodot I</i>	364

9. LINKING SCIENCE TO PRACTICE: TOOLS TO ASSESS RIVER STATUS AND GUIDE REHABILITATION TO OPTIMIZE RIVER BASIN MANAGEMENT 369

RESTORE'S MULTIPLE BENEFITS FOR RIVER RESTORATION AND THE ECRR <i>Baker C</i>	370
APPROACHES TO CONSIDER THE RECOLONISATION POTENTIAL IN RESTORATION PLANNING <i>Dahm V & Hering D</i>	371
SEMI-AUTOMATED RIVERSCAPE UNITS CLASSIFICATION AND ACTIVE RIVER CHANNEL DELINEATION FOR THE PIEDMONT REGION (ITALY) <i>Demarchi L & Bizzi S</i>	376
EUROPEAN CENTRE FOR RIVER RESTORATION AND RIVER RESTORATION THROUGH THE YEARS! <i>Fokkens B</i>	382

TOWARDS AN HARMONIZED UNDERSTANDING OF MITIGATION MEASURES AND IMPLEMENTATION THEREOF TO REACH GOOD ECOLOGICAL POTENTIAL (GEP) IN WATER BODIES IMPACTED BY WATER STORAGE ACROSS EUROPE <i>Halleraker et al.</i>	385
ASSESSING ALTERNATIVE CONSERVATION STRATEGIES FOR THE ANASTOMOSING RIVER NAREW <i>Marcinkowski P, Grabowski R C & Okruszko T</i>	391
ECOLOGICAL EVALUATION & HYDRAULIC MODELLING OF THE 'PROCESS RESTORATION' PHILOSOPHY ON THE ALLT LORGY, SCOTLAND <i>Moir H & Gillies E</i>	397
EVALUATION AND PRIORITIZATION OF RIVER REHABILITATION PROJECTS <i>Reichert P, Paillex A & Schuwirth N</i>	401
NEW TOOLS FOR AN INTEGRATED HYDROMORPHOLOGICAL ASSESSMENT OF EUROPEAN STREAMS <i>Rinaldi M et al.</i>	406
FISH FAUNA AS INDICATOR FOR LARGE RIVER-FLOODPLAIN ALTERATIONS. CASE STUDY: DANUBE DELTA <i>Staras M</i>	413
ECOSTATUS: A METHODOLOGY TO ASSESS THE RIVER AND ITS SURROUNDING AREA TO INFORM PROJECT DESIGN AND APPRAISAL <i>Wharton G et al.</i>	419

1. Scope, Objectives and Topics

Conference scope and objectives

The purpose of the conference is to enlarge awareness of the need and appreciation for the benefits of river rehabilitation. It will serve as a platform to present and discuss aspirations, challenges, analytical frameworks and novel approaches to improve our understanding of the causes and consequences of hydromorphological degradation and to enhance river rehabilitation.

40% of European rivers are affected by hydromorphological pressures caused predominantly by hydropower, navigation, agriculture, flood protection and urban development. This conclusion is based on the recent analysis of River Basin Management Plans for the EU Water Framework Directive (WFD). As a consequence, there is increasing emphasis on river restoration driven by demands of the WFD. To improve ecological functioning of rivers and streams EU member states have drafted programmes of measures focusing on restoring river hydrology and morphology. Implementation will require substantial investment in these measures, but there remains a need to better understand and predict the costs and benefits of future river restoration. Ecological response to hydromorphological restoration, however, is complex and poorly understood.

Against this background, REFORM has developed tools for i) cost-effective restoration of river ecosystems and ii) improved monitoring of the biological effects of physical change by investigating natural, degradation and restoration processes in a wide range of river types across Europe. The conference aims to present the major outcome of REFORM, together with excellent work from other studies from Europe and other continents.

Conference topics

Assessment and rehabilitation of hydromorphological processes in rivers

Hydromorphological processes operate across space scales from catchment to site and vary through time across all space scales to drive river morphodynamics. We invite contributions on multi-scale approaches to the assessment of hydromorphological condition and the development of sustainable rehabilitation measures. Contributions that link hydromorphology with ecology are also welcome.

Discerning the impact of hydromorphological modification from other stressors

The majority of rivers and floodplains have been degraded by a multitude of anthropogenic impacts and are among the ecosystems that have seen the largest decline in biodiversity worldwide. Habitat modifications resulting from substrate extraction, channel re-sectioning, damming, etc., reduce ecological quality through homogenization of biotopes and loss of connectivity. It is a major challenge to disentangle and quantify the impact of habitat degradation from the multiple stressors that act on riverine ecosystems. We show ways forward and invite contributions on how to assess

hydromorphological degradation using existing biomonitoring methods and identify which of the WFD compliant biological quality elements are most sensitive to this type of stress.

Achievements by restoration and mitigation practices

Worldwide, rivers are being restored to enhance fish habitats, to increase attractiveness and to improve ecosystem services and biodiversity. River restoration is a business worth billions of Dollars/Euros and driven by societal demands and respective legislation. In sharp contrast is the knowledge about restoration effects and factors responsible for success or failure. The majority of measures have not been subjected to monitoring. We will present our review of published studies on river restoration effects and our extensive field studies on how different restoration measures affect hydromorphology, river and floodplain biota and functions and invite contributions demonstrating restoration achievements.

How to improve the (cost-)effectiveness of river rehabilitation?

River restoration is expected to deliver a multitude of ecosystem services and societal benefits. Many of these benefits can be characterized as public goods, making it difficult to quantify them in economic terms for comparison with the costs of river restoration. River restoration can be costly and it is therefore paramount to identify the most cost-effective way to improve ecological status as required by the WFD, and simultaneously maximize the broader benefits associated with habitat and ecosystem rehabilitation. Possible trade-offs with other sectoral interests, for example navigation and hydropower, are ideally accounted for, as well as the causal link between restoration efforts, biophysical effects, ecosystem services and socio-economic benefits based on integrated hydro-ecological-economic modeling. Conceptual and applied case study contributions addressing these key methodological issues are invited.

Benefits of river rehabilitation and synergies with other uses (flood protection, navigation, agriculture, hydropower)

There is considerable conflict between river rehabilitation objectives and those of other water sector drivers, such as flood prevention, hydropower, navigation and agriculture. However, there are equally substantial benefits and synergies that can be gained if the various sectors work together to achieve sustainable outcomes that improve the ecological status of rivers. This section is looking for case studies, policy frameworks and guidance to promote synergies between sectors to facilitate sustainable rehabilitation activities in multiple user environments.

Linking science to practice: tools to assess river status and guide rehabilitation to optimize river basin management

Translating scientific knowledge into guidance for river restoration practitioners presents a major challenge. We invite contributions on practical tools to assess river status and guide rehabilitation to optimize river basin management. More generally, we welcome contributions on best practices of using scientific knowledge in river restoration projects.

Impression of the REFORM conference



Impressions of the plenary sessions



Impressions of the plenary sessions

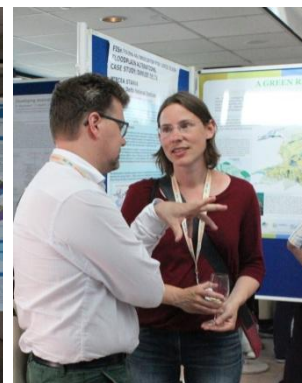
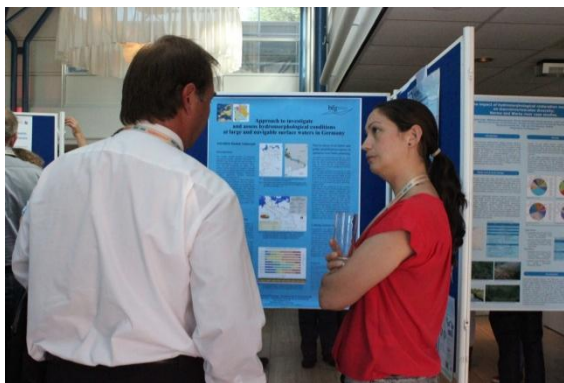
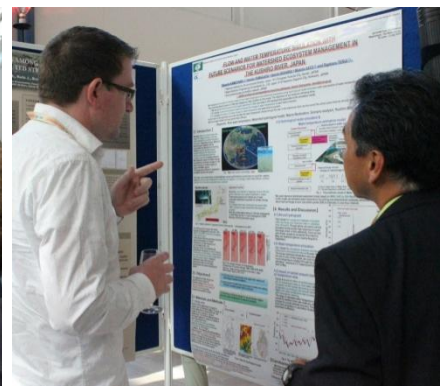
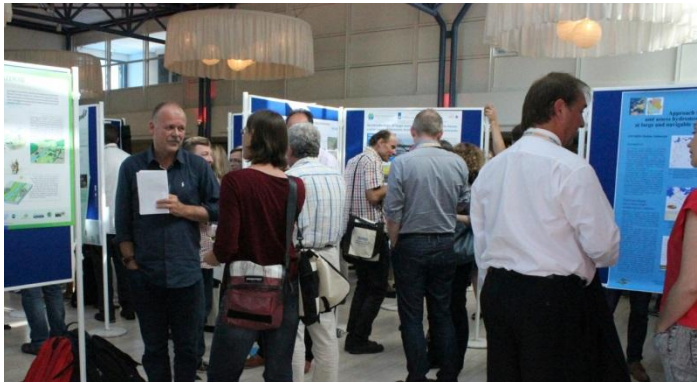

Impressions of the poster session



Impressions of the conference dinner



Impressions of the Room for the River excursion

2. Advisory board feedback on REFORM's final conference

Organisation and structure of the Conference

- This was an excellent conference, very well organized, interesting and fun.
- The structure of the programme was very good, linking the keynotes with more detailed oral presentations and case studies in the parallel sessions.
- There were excellent speakers for the keynotes that brought things together. The talks from outside Europe were particularly inspiring.
- The conference showed clearly the synthesis of REFORM results, and the good cooperation between partners and work packages. The REFORM project is progressing coherently and results are converging.
- There were many participants external to the REFORM project, although few stakeholder representatives attended. Different key sectors were missing, e.g. from the agriculture or hydropower sector, who might have brought in different perspectives.

Content highlights

- There was a wide span of presentations from global to catchment view and all the way down to species level.
- There were inspiring contributions and key messages on:
 - The need to develop process-oriented restoration measures to kick off natural dynamics in rivers and from there letting rivers to 'restore themselves'
 - The role of the riparian zone and the floodplain for ecosystem functioning
 - Biotic indices to establish correlations to morphology and connectivity relationships in catchments (e.g. dragonfly index developed in Italy)
 - The length of restoration stretches, pointing out it is important to restore portions of our rivers to high quality; these can be important for dispersal and for supporting pioneer conditions.
 - The importance of disentangling effects of multiple pressures
 - Breaking new ground of bringing hydromorphology and the evolutionary trajectory together.
- The conference also served to promote the idea of integrated river basin management. Restoration is not the only measure to consider. Rather than repair, we should also have measures to prevent degradation (conservation).
- In addition, there was general agreement that we have to promote interdisciplinary research. Faced with complex problems to solve, we have to work together to provide knowledge for river managers.
- In the same time, many presentations did not seem particularly new (e.g. on spatial and temporal variability, processes rather than static state, value of edge habitats), but key issues were newly discovered and reinforced.
- The requirements of EU directives were not mentioned very often. In that respect, it would be useful to formulate some recommendations for end-users and water managers on targeted river restoration measures for specific types of degradation and for better integrating legal requirements of e.g. the WFD, Floods Directive or Habitats and Birds Directives.
- It was useful to have a fieldtrip to put things in context. Everything in restoration is contextual. Issues around participation structures and decision making processes were embedded in the case study sites visited.

Feedback on the REFORM final conference was given by the following members of the Advisory Board:

- Ursula Schmedtje, European Topic Center on Inland, Coastal and Marine waters.
- Gary Brierley, University of Auckland, New Zealand.
- Herve Piegay, National Center for Scientific Research (CNRS), France.
- Bas van der Wal, Foundation for Applied Water Research (STOWA), The Netherlands.
- Johan Kling, Planning Department, Water resource management unit, The Swedish Agency for Marine and Water Management, Sweden.

3. KEYNOTES

Linking science to practice: tools to assess river status and guide rehabilitation to optimize river basin management

Brierley G

GARY BRIERLEY

*School of Environment. The University of Auckland, Private Bag 92019. Auckland City
1142
NEW ZEALAND.*

ABSTRACT

How are we knowing our rivers? What toolkits, building upon which foundations, do we use to assess river character, behaviour, condition, pressures, limiting factors, evolutionary traits, and likely futures? Perhaps more importantly, how do we frame these understandings alongside local knowledges to inform river restoration? The REFORM project has made many advances in developing an integrating platform for such endeavours. Importantly, the integrative hydrogeomorphic template that has been produced is cross-scalar (hierarchical), process-based, and is readily adapted to the wide range of conditions across Europe (and beyond). Framing catchment-based approaches in their regional context provides an important basis to work with change, supporting meaningful transferability of understandings from one situation to another. This helps to evaluate impacts of cumulative effects, rather than endeavouring to address issues in isolation.

Stakeholder (end user) deliberations fashion the development and use of information that shapes *how we are managing our rivers*. Effective management extends well beyond mere transfer or translation of scientific tools into practice. Rather, a process of negotiation is most readily facilitated through adaptive practices that apply flexible (non-prescriptive), readily usable, and appropriately tested (and validated) toolkits. Local circumstances, key values, and policy framings determine which approaches gain primacy. Thankfully, there is general agreement on the core principles upon which most hydrogeomorphic river classification toolkits build, such that 'differences' are generally relatively superficial. However, these differences may have significant real-world consequences. Critically, decisions made in these deliberations influence how emerging technologies and automated procedures underpin monitoring and modelling applications, in turn fashioning *how we are making the world*. There is an inherent politics in the ways in which we respect difference, striving to ensure that we do not set out to 'make rivers the same' (Tadaki et al., 2014)? In considering such matters, and their material implications, *what are the rights of the river itself?*

A PERSONAL PERSPECTIVE ON THE USE OF TOOLKITS AT THE INTERFACE OF RIVER SCIENCE AND MANAGEMENT

The toolkits we use to inform river management shape the way we see the world. Perhaps inevitably, we choose the toolkits we like – the ones that work well for the job at hand, that we are comfortable with. Essentially, we typically select those approaches that conform to our own worldviews. These frameworks are not static – they are amended, extended and tweaked to fit differing circumstances. In virtually all instances, a given approach is eventually replaced, as other tools are considered to be more appropriately 'fit to purpose', or fit more appropriately for the politics of the day, or the aspiration of the user. These critical issues have manifest and material outcomes for the rivers themselves. How we know our rivers has enormous implications for how we seek to manage them, and the consequences of our efforts to 'make the world' within a particular

vision. All too often, scientific and technical deliberations are conducted with too little consideration of these circumstances and the outcomes that ensue. In framing this address, I have chosen to focus upon these broader implications of practice, highlighting personal reflections upon the design and implementation of approaches to applied river science that seek to inform (or guide) management activities.

It is now widely accepted that geomorphic principles provide a critical template upon which biophysical, socio-economic and cultural factors interact. Things happen in space. The geography and history of a given setting fashion the nature and consequences of these interactions. Hence, a landscape platform provides an ideal starting point for many deliberations in environmental science and management. For example, Wilcock et al. (2013) envisage geomorphic framings as a basis for analyses of 'cultural-and-biophysical landscapes'. The configuration and connectivity of gravitationally-induced process relationships in any given catchment provides a logical starting point for such analyses. Sadly, these simple framings are all too often overlooked, as concerns for riverscapes undertaken at a particular site or reach fail to give due regard for position within a catchment and off-site impacts of actions that are taken (cf., 'Don't fight the site'; Brierley and Fryirs, 2009). The rhetoric of nested hierarchical framings that emphasize how component parts of river systems fit together within catchments, and how catchments themselves can be framed within a particular bio(eco)region is relatively straightforward (e.g. Gurnell et al., 2015). However, the use of these notions to inform and underpin management practices occurs all too infrequently, and should never be simply 'assumed'. Context is everything.

In this paper I make three primary observations about the way we develop biophysically-based toolkits to inform river management applications:

1. However challenging it may prove to be, it is more useful, reliable and accurate to conduct investigations of river systems from an integrative perspective at the outset than it is to undertake siloed discipline-bound investigations and try to pull them together. My advice would be to spend time developing a coherent model of how a given river system works, and test it iteratively through management applications (see Mika et al., 2010). Fragmented science can only engender fragmented management. Penck (1897) provided sage guidance in promoting the field of potamology (river science). Sadly, we've been very effective at pulling river systems apart, in finer and finer detail, but we've been pretty hopeless as pulling them together again to provide a coherent (integrative) knowledge base to inform management.
2. There are innate dangers in a world of fashion, and the unintended consequences of 'throwing the baby out with the bathwater'. Effective management will not be engendered by simply using the 'latest and greatest' toolkit to the exclusion of others. In the past, management agencies were forever confronted by visiting 'experts' pushing particular perspectives. This factor, among many, helped to engender management agendas that were driven by singular concerns, typically addressed within a singular disciplinary frame. Emphasis for 'control' and management of floods brought about the primacy of engineering and hydrological applications. Alarm for river condition initially prompted applications that sought to address concerns for water quality and pollution management, but subsequent concerns for biodiversity loss triggered analyses of habitat availability and viability (geo-ecology). Ultimately, however, river health reflects the composite of all these concerns. Moving beyond notions of disciplinary fashion, it is important to consider the trends and preferences within any given field of enquiry. In moving forward, it is vital not to overlook foundation (tried and tested) principles. Logical and coherent frameworks are

required to bring these various threads together. Such framings must be inherently process-based, addressing underlying causes of degradation rather than their symptoms. Without wanting to play too much with the 'fashion' pun, emphasis should be placed upon how a system works, alongside what it looks like. In geomorphic terms, such process-form linkages are tied to analyses of pattern, and the ways in which process relationships are played out at the catchment scale.

- Analyses are innately limited unless they provide meaningful guidance into the likely range of future states and process relationships that may be experienced by a given river (e.g. Belletti et al., 2014; Grabowski et al., 2014). Looking backwards is vital in informing these assessments, but ultimately our core responsibility lies in informing the future, establishing a basis to establish and interpret a range of target conditions that reflects prospective trajectories of adjustment. In geomorphic terms, pro-active rather than re-active applications build upon catchment-specific understandings of evolutionary traits and how disturbance responses are conveyed through a river system over what timeframe (Fryirs et al., 2009). While recovery notions are appropriately contested as efforts to 'return to some condition from the past', analyses of recovery potential provide critical guidance in assessing what is realistically achievable in the management of a river system today (and into the future). So much depends upon the path dependencies that have been set. This provides a salutary reminder of the importance of our actions today, and the legacies we engender. In this light, a conservation focus always comes to mind – prioritize looking after the good bits first, in efforts to ensure that they do not become problems in the future (prevention is cheaper and more effective than cure). In a rapidly changing world, where notions of no analogue states and novel ecosystems are increasingly *de rigeur* (however fashionable they may/may not be), perhaps the most critical determinant of future river condition will be how we choose to deal with uncertainty and emergence. Personally, whenever possible I'd recommend leaving things to the river itself as far as practicable – I'm a passionate advocate of space to move and freedom space initiatives (e.g. Biron et al., 2014; Piegay et al., 2005), and I have immense respect for those pioneering practitioners who have promoted and engendered such activities in different parts of the world.

Inevitably, it is one thing to develop toolkits, and quite another to think about how they are used. Putting aside assumptions about the underlying assumptions that are incorporated within any particular toolkit, and its appropriateness for the task at hand, some generic comments can still be made regarding appropriate use of these toolkits. First and foremost, it is vital to retain a questioning mindset, forever pondering how relevant, pertinent, appropriate and reliable the toolkit may be in a given instance (i.e. engage they brain!). Just as importantly, it is important that any concerns that are raised during an investigation should be incorporated within the results that present the findings from that application. Such is the danger of overly prescriptive, inflexible toolkits. In a world of continua, open-ended thinking is required to highlight whereabouts upon a spectrum a given situation is considered to fit. In this regard, archetypes provide a more appropriate framing than classes, allowing determinations of the 'degree of fit' to any given class, and overlap between classes (it may be this, it may be that; under this set of circumstances, this category is appropriate, but if conditions change, the system better conforms to another category). Such framings help to deal with concerns for the 'range of variability' of any given system, rather than placing undue emphasis upon an average condition (and associated notions of meaningless means). Unfortunately, the quest for adaptable and flexible framings flies in the face of the ease of use (operability) of any given tool. My response here is a simple one. Rivers are complex, living systems. Why expect their behaviour and responses to disturbance events to be simple? In this light,

pigeon-holing rivers into a particular class and applying a prescriptive cookbook to establish approaches to their management is naïve indeed. This is a useful starting point, but it should be viewed as a basis to test observations, not an end-point in the quest to 'make rivers the same' (Tadaki et al., 2014).

I would like to make three key points in the use of a given toolkit:

1. Ensure it measures the right thing in the right way, in the right place at the right time. Efforts should emphasize process-based understanding of the range of behaviour and evolutionary trajectory of a system, meaningfully separating assessment of geomorphic river condition from the character and behaviour of a river, giving careful consideration of what to measure against (Rinaldi et al., 2014, 2015). For example, the extent and rate of bank erosion along a reach should be assessed relative to 'what is expected' for that type of river (i.e. virtually all banks of a braided river may be eroding, whereas bank erosion for an active meandering river would be expected along the outer (concave) bank, while erosion is seldom observed along a passive meandering or anastomosing system). Similar thinking should be applied in considering appropriate measures of geodiversity. Heterogeneity is not always expected for a river. The geomorphic structure and function of some types of river are innately simple, so a 'high' geodiversity score should not be expected (Fryirs and Brierley, 2009).
2. Ensure that the toolkit is appropriately validated. Effective uptake comes from the tweaking that accompanies recurrent use, monitoring, testing and reporting. Information management is vital. Maintaining a living record of what we are doing is critical if we are to meaningfully 'learn as we go'. Sadly, there are countless instances in which knowledge bases and institutional memory are too short or lacking, so wheels are forever being reinvented.
3. Ensure that due caution is applied in considering the transferability of understandings from one river situation to another. This pivotal but difficult undertaking has received far too little attention in our efforts to make effective use of what we know about rivers. One of the key issues here is the impasse – the near vacuum – between scientific framings and practical toolkits that support genuine and recurrent application. In a sense, perhaps we don't have enough cookbooks to give managers choice in the selection of approaches to apply (Wheaton, *pers. comm.*). In my opinion, the research community continues to be negligent in working genuinely and deeply alongside stakeholders and end users in the co-development of toolkits so that they are appropriately designed and implemented (Rogers, 2006; I feel the Italian component of REFORM should be flagged and praised as a clear exception to this trend). As a side note to this assertion, very few comparative assessments of the toolkits that are available have been performed. Researchers are forever 'quibbling around the edges' in efforts to promote the primacy of one approach over another, highlighting difference when there may be significant accord of findings (after all, most approaches build upon the same scientific foundations). Another dilemma may be experienced at the other end of the spectrum, however. When presented with a plethora of toolkits that fulfil slightly different purposes, how meaningfully and effectively can we 'pull them together' to provide coherent guidance for integrative management practices?

And if it wasn't already complicated enough, we are increasingly overwhelmed by a vast array of new techniques and analytical approaches that generate vast volumes of data in seemingly uncontrollable, relatively undirected ways. The opportunities of 'extreme science' (Brasington, *pers. comm.*) are truly phenomenal, but the proof is in the pudding in our efforts to make this something other than a massive data-generating exercise.

Ultimately, management applications come down to the questions asked and the coherence of the guidance that is provided to address issues raised. Automated, remotely-sensed procedures and monitoring applications offer enormous prospect in expanding our understandings of the range of behaviours of river systems, and their evolutionary traits. Change detection techniques have already triggered a host of questions about how rivers work, requiring new process-based understandings (e.g. analyses of where sediments are reworked on braidplains during flood events of differing magnitude). At the same time, enhanced awareness of the range of variability of a river generated from more readily available data may help to reframe subjective assertions about good, moderate or poor variants of geomorphic condition of a river by allowing the river to 'speak for itself' in demonstrating its own range of variability.

On the one hand, these developments could lead us to a world in which it may be perceived that 'it isn't real until it's virtual'. On the other hand, our capacity to develop place-based (yet appropriately contextualized) understandings of river systems has never been greater. Concerns for naughty or perfect landscapes (Kennedy, 1979; Phillips, 2007) should not be misconstrued as inherently limiting factors in considering how to transfer understandings from one catchment to another – so long as this task is undertaken with due consideration of inherent complexities and uncertainties. When applied appropriately, new data sets will help to support assessments of the transferability of understandings of catchment-scale process relationships. The notion of 'topographic grain' may provide a useful and relatively underexplored tool with which to inform these enquiries. What is the critical scale of analysis that most reliably helps to unravel process relationships in any given system (e.g. hillslope length, ridge-valley-floor spacing)? Such determinations have major implications for the choice of scale of analysis for a given problem (i.e. the scale of the analytical lens, such as the pixel size in DEM deliberations).

It feels strange to approach the end of this 'applied' contribution yet only now focus on the management realm itself. While scientific and technical guidance are fundamental to effective practice, they are but a small part in the institutional and political processes that are at-play in determining which scientific guidance to follow, and which to ignore. Two key considerations help facilitate the uptake of scientific toolkits to support management applications and their incorporation into policy (e.g. Brierley et al., 2011). First, procedures should be co-developed through extensive consultation with practitioners, end users and the people who live along the rivers of concern, ensuring that the approach had genuine value in addressing local issues. Second, procedures must be recurrently tested and refined as a basis for their validation. Professional short courses and training programmes, conducted within a co-learning environment, may be required to support these endeavours.

Which framing makes it to the policy arena? Ultimately, deliberations fashion how 'what we know about rivers' is selectively applied in river management. Sadly, these issues are a much maligned and unfashionable area of enquiry that is often seen as unduly political or the 'dark side' of scientific endeavour. Personally, I feel we need to engage much more substantively with 'sociogeomorphology' (Ashmore, 2015), recognizing the socio-cultural and political undercurrents of our work and practice (Tadaki et al., 2012). I believe that it is only through these encounters, engagements and 'collisions' that we will be able to create more equitable and just approaches to river science and management – something that provides genuine prospect for citizen science initiatives as part of the democratization of science.

So, how are we knowing our rivers, and how are we making the world? Are we respecting difference, or are we striving to make rivers the same? Do we really 'know our catchment', or are we applying generic principles to a given situation? And finally, how well do our efforts represent the rights of the river itself?

References

- Ashmore, P.A. (2015). Towards a sociogeomorphology of rivers. *Geomorphology*. In press. doi: 10.1016/j.geomorph.2015.02.020
- Belletti, B., Rinaldi, M., Buijse, A.D. et al. (2014). A review of assessment methods for river hydromorphology. *Environmental Earth Sciences*. 73: 2079-2100.
- Biron, P.M., Buffin-Bélanger, T., Larocque, M. et al. (2014). Freedom space for rivers: A sustainable management approach to enhance river resilience. *Environmental Management*. 54: 1056-1073.
- Brierley, G.J., Fryirs, K.A. (2009). Don't fight the site: Three geomorphic considerations in catchment-scale river rehabilitation planning. *Environmental Management*. 43: 1201-1218.
- Brierley, G., Fryirs, K., Cook, N. et al. (2011). Geomorphology in action: Linking policy with on-the-ground actions through applications of the River Styles framework. *Applied Geography*. 31: 1132-1143.
- Brierley, G.J., Fryirs, K.A., Cullum, C. et al. (2013). Reading the landscape: Integrating the theory and practice of geomorphology to develop place-based understandings of river systems. *Progress in Physical Geography*. 37: 601-621.
- Fryirs, K.A., Brierley, G.J. (2009). Naturalness and place in river rehabilitation. *Ecology and Society*. 14 (1), 20.
- Fryirs, K., Spink, A., Brierley, G.J. (2009). Post-European settlement response gradients of river sensitivity and recovery across the upper Hunter catchment, Australia. *Earth Surface Processes and Landforms*. 34, 897-918.
- Gurnell, A.M., del Tánago, M.G., Rinaldi, M. et al. (2015). Development and application of a multi-scale process-based framework for the hydromorphological assessment of European Rivers. In: *Engineering Geology for Society and Territory-Volume 3* (pp. 339-342). Springer International Publishing.
- Grabowski, R.C., Surian, N., Gurnell, A.M. (2014). Characterizing geomorphological change to support sustainable river restoration and management. *WIREs Water*. 1: 483-512.
- Kennedy, B.A. (1979). A naughty world. *Transactions of the Institute of British Geographers*. 4: 550-558.
- Mika, S.J., Hoyle, J.T., Kyle, G. et al. (2010). Inside the 'black box' of river restoration: Using catchment history to identify disturbance and response mechanisms to set targets for process-based restoration. *Ecology and Society*. 15(4): 8.
- Penck, A. (1897). Potamology as a branch of physical geography. *The Geographical Journal*. 10: 619-623.
- Piégay, H., Darby, S. E., Mosselman, E. et al. (2005). A review of techniques available for delimiting the erodible river corridor: a sustainable approach to managing bank erosion. *River Research and Applications*. 21: 773-789.
- Phillips, J.D. (2007). The perfect landscape. *Geomorphology* 84: 159-169.
- Rinaldi, M., Surian, N., Comiti, F. et al. (2013). A method for the assessment and analysis of the hydromorphological condition of Italian streams: the Morphological Quality Index (MQI). *Geomorphology*, 180, 96-108.
- Rinaldi, M., Surian, N., Comiti, F. et al. (2015). A methodological framework for hydromorphological assessment, analysis and monitoring (IDRAIM) aimed at promoting integrated river management. *Geomorphology*. In press. doi: 10.1016/j.geomorph.2015.05.010
- Rogers, K.H. (2006). The real river management challenge: integrating scientists, stakeholders and service agencies. *River Research and Applications*. 22: 269-280.

- Tadaki, M., Salmond, J., Le Heron, R. et al. (2012). Nature, culture, and the work of physical geography. *Transactions of the Institute of British Geographers*. 37: 547-562.
- Tadaki, M., Brierley, G.J., Cullum, C. (2014). River classification: Theory, practice, politics. *WIREs Water*. 1: 349-367.
- Wilcock, D., Brierley, G.J., Howitt, R.I. (2013). Ethnogeomorphology. *Progress in Physical Geography*. 37: 573-600.

The socio-economic benefits of river restoration

Brouwer R et al

ROY BROUWER, OLEG SHEREMET & DEVI BRAND

Department of Environmental Economics, Institute for Environmental Studies, Vrije Universiteit Amsterdam

Introduction

River restoration provides a wide array of hydrological, ecological and socio-economic benefits. Many of these benefits are so-called public goods and services provided by restored or natural river systems, and can only be estimated in monetary terms using non-market valuation techniques. A limited number of such non-market valuation studies exists, which are summarized and synthesized in a structured way in the meta-analysis in this paper. Meta-analysis is a method of synthesizing the results of multiple studies that examine the same phenomenon, in this case the estimated non-market benefits associated with river restoration, through the identification of a common effect, which is then 'explained' using regression techniques in a meta-regression model (Stanley, 2001). In this study we conduct a meta-analysis to identify and quantify the key determinants of the economic value of river restoration projects around the world. Based on the specifications of previous meta-analyses of wetland values and on theoretical expectations we define four groups of explanatory variables that represent different determinants of variation in the nonmarket values found in the literature, namely the characteristics of the ecosystem services provided by river restoration, the characteristics of the river and location where the restoration took place, the socio-economic characteristics of the population of ecosystem service beneficiaries, and the characteristics of the valuation methodology.

Study selection

Existing studies about the socio-economic benefits of river restoration were selected based on two criteria. First, the studies were required to address river restoration. The *REFORM restoration measure typology* in Ayres et al. (2014) was used as a guideline to determine whether the measures evaluated in a particular study could be seen as river restoration measures. Second, in order to be selected, the study had to focus on the economic valuation of the impacts of the river restoration measures. This resulted in a database consisting of 39 international studies.

The relevant scientific articles were found via Google Scholar and the e-library of the VU University Amsterdam. In the search process we used key words such as *river*, *stream* and *watershed* to indicate the relevant type of waterbody. The words *restoration*, *rehabilitation* and *instream flow protection* were used to indicate the relevant type of improvement to be valued. *Contingent valuation*, *choice experiment*, *willingness to pay* and *willingness to accept*, and their abbreviations *WTP* and *WTA* respectively, were used to search for relevant non-market valuation methods. The data provided in the collected papers were complemented with publicly available economic and socio-demographic data, climatic and geographic characteristics of the river study locations, and information derived from maps and related river images available on the web. Monetary values such

as willingness to pay and income were all made comparable for the same 2013 price level using purchasing power parities (PPP) and annual inflation indices.

Summary economic values of benefits of river restoration

The database contains 39 different scientific articles that assess the non-market value of river restoration projects. The studies presented and discussed in these articles were conducted over a time span of 18 years, between 1995 and 2013, although only four studies were conducted before 2001, see Figure 1. Geographically, the majority of studies come from Europe (22 studies), followed by America (12 studies) and Asia (5 studies).

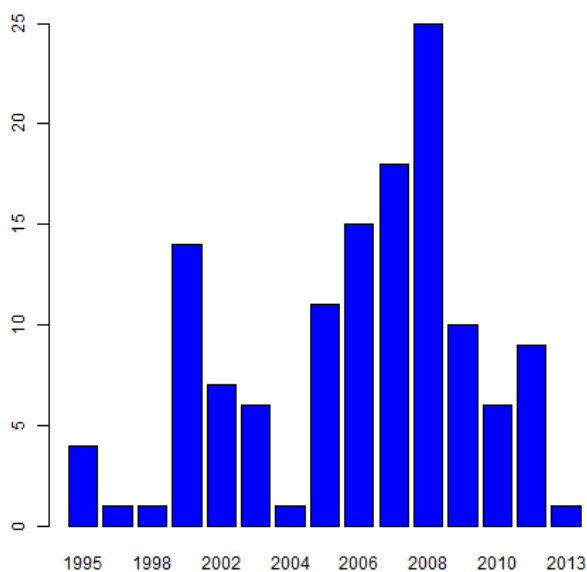

Figure 1. Distribution of number of studies in the database by year.

Overall, 129 monetary values were extracted from those papers, including 88 mean WTP and 24 marginal WTP estimates, adjusted for PPP and inflation and expressed in 2013 price level euros. In terms of valuation methods, contingent valuation (CV) is used as valuation technique in 21 of these articles, choice experiments (CE) in 11 articles, and in the rest other non-market valuation techniques are used. For the meta-analysis, the database is limited to those papers focusing on CE and CV estimates. This yields 29 papers with 109 monetary observation, including 86 mean WTP estimates (see the summary in Table 1).

Table 1. Summary of the number of estimates across value elicitation formats.

Study formats	# of WTP values	# of marginal WTP values
Choice Experiment	35	21
Contingent Valuation:		
- dichotomous choice	21	
- polychotomous choice	25	1
- open-ended WTP format	5	1
Total:	86	23

Many of the proposed restoration measures could not be categorized into one of the eight classes and had to be classified as 'other measures'. This becomes clear by looking at the last row of Table 2, which shows that more than half of the studies proposed at least one measure which had to be categorized as 'other measure'. The distribution of restoration measure frequencies is very uneven: riparian zone improvements were considered in almost 36% of the studies, while sediment flow quantity improving measures proved to be the least frequently studied class of measures in river restoration and included in only one study.

Table 2. Distribution of studies and estimates across river restoration measures.

Restoration measure class	Number of studies
Water flow quantity improvement	6
Sediment flow quantity improvement	1
Flow dynamics improvement	4
Longitudinal connectivity improvement	3
River bed depth and width variation improvement	5
In-channel structure and substrate improvement	6
Riparian zone improvement	14
Floodplains/off-channel/lateral connectivity habitats improvement	7
Other hydrological / morphological improvements	20

The distribution of mean WTP estimates across the entire database is skewed, with the mean value being €69.9 per household per year and the median €43.1 per household per year (see Figure 2). Although there are some differences in WTP estimates averaged across world regions, e.g. €66.5 for Europe, €64.0 for Asia, and €76.9 for America, statistical tests do not indicate that there are significant differences between these values. At the same time, as Figure 3 shows, there is much more variation at individual country level, with mean WTP ranging from €11.3 for Korea to €118.0 for Scotland.

Comparing the mean WTP values across different elicitation methods, we find that the average WTP value derived from choice experiments (€95.5) is significantly higher than the average WTP value for contingent valuation studies (€52.3). However, differences in average WTP values for the different CV elicitation formats are contrary to expectations not statistically significant.

Finally, the list of ecosystem services and benefits valued in the different studies is presented in Table 3. The most frequently valued benefits are related to general ecology and water quality improvements, followed by increased recreational suitability and improved aesthetics. Flood and erosion control are not routinely used in assessing the benefits of the river restoration studies.

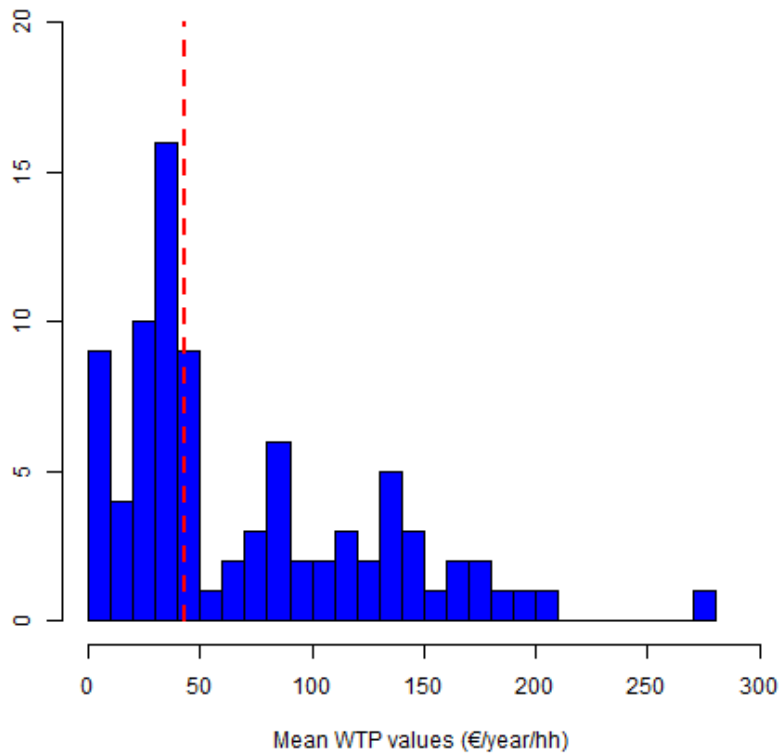

Figure 2. Histogram of mean WTP values for river restoration across all regions, in 2013 euro prices per household per year (red line indicates the median WTP estimate).

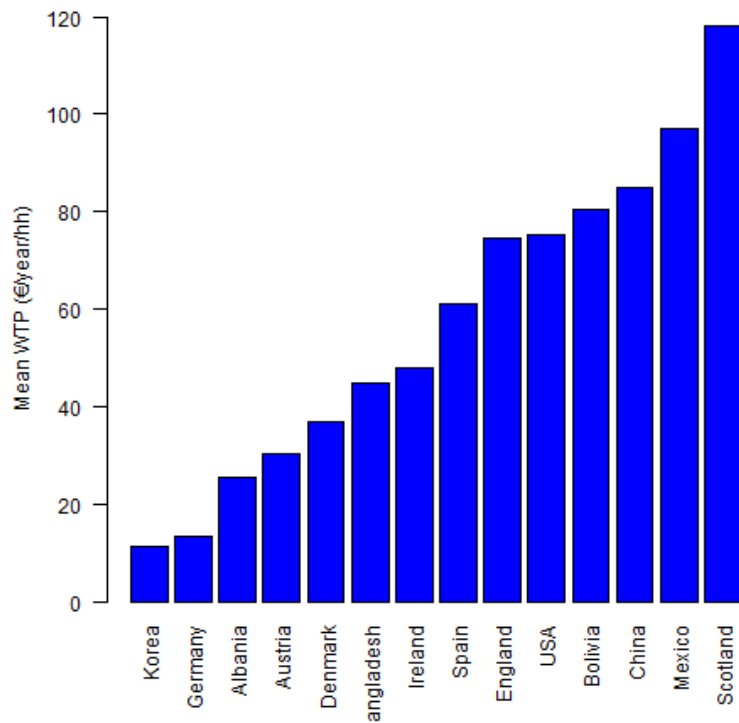

Figure 3. Ordered mean WTP across countries, in 2013 euro prices per household per year.

Table 3. Distribution of studies across restoration-based ecosystem services' benefits.

River restoration benefit	Number of studies
Ecological improvement	22
Water quality improvement	21
Flow rate increase	10
Erosion control	7
Local economic impact	12
Flood risk reduction	3
Better aesthetics	9
Recreational suitability	15

REFORM: scientific progress and tools for water management

Buijse T *et al.*TOM BUIJSE¹, ERIK MOSSELMAN¹, IAN COWX², NIKOLAI FRIBERG³, ANGELA GURNELL⁴, DANIEL HERING⁵, ELEFThERIA KAMPA⁶, CHRISTIAN WOLTER⁷¹ Deltares, DELFT, the Netherlands² University of Hull, HULL, UK³ NIVA, OSLO, Norway⁴ Queen Mary University of London, LONDON, UK⁵ University of Duisburg-Essen, ESSEN, Germany⁶ Ecologic Institute, BERLIN, Germany⁷ Leibnitz-Institute of Freshwater Ecology and Inland Fisheries, BERLIN, GermanyEmail: tom.buijse@deltares.nl

Context and objectives

Europe is characterized by a dense network of rivers that provide essential ecosystem services. From an ecological perspective, rivers and their floodplains form some of the most diverse ecosystems worldwide. Recent analysis of the first round of WFD River Basin Management Plans (RBMP) indicated that 40% of European rivers are affected by hydromorphological (HYMO) pressures caused predominantly by hydropower, navigation, agriculture, flood protection and urban development. As a consequence, there is increasing emphasis on river restoration driven by demands of the WFD and EU States have drafted programmes of measures focusing on restoring river hydrology and morphology. Implementation will require substantial investment in these measures, but there remains a great need to better understand and predict the costs and benefits of future river restoration.

Against this background, REFORM's goal is to generate tools for cost-effective restoration of river ecosystems, and for improved monitoring of the biological effects of physical change by investigating natural, degradation and restoration processes in a wide range of river types across Europe. The consortium is composed of 26 partners from 15 European countries representing a wide range of disciplines: hydrology; hydraulics; geomorphology; ecology; socio-economics; and water management. REFORM's objectives are grouped into three categories: application, research and dissemination.

Application

1. Select indicators for cost-effective monitoring of physical habitat degradation and restoration.
2. Improve tools and guidelines for HYMO restoration and mitigation.

Research

3. Review existing information on river degradation and restoration.
4. Develop a process-based HYMO framework relevant for ecology and suitable for monitoring.
5. Understand how HYMO pressures interact with other stressors and constrain restoration.
6. Assess the importance of scaling on the effectiveness of restoration.

7. Develop instruments for risk and benefit analysis to support successful restoration.

Dissemination

8. To increase awareness and appreciation for the need, potential and benefits of river restoration through active interaction with stakeholders.

Interim results

The REFORM project has generated substantial mid-term outputs to support River Basin Management Planning for the Water Framework Directive.

- Interim results have been synthesised and made available to practitioners in an accessible way by the set-up and population of a WIKI (<http://wiki.reformrivers.eu>; Mosselman et al. 2013).
- Key HYMO processes and variables indicating success in river restoration have been reviewed (Garcia de Jalon et al. 2013; Figure 1. HYMO variables that influence ecological status and functioning have been linked to the tolerance thresholds of species with emphasis on macrophytes, macroinvertebrates and fish (Wolter et al. 2013). The dynamics of flowing water emerged as the most important HYMO process. Coarse gravel maintained by stream power and flow velocity emerged as key indicator. Significant knowledge gaps need to be addressed for habitat requirements of riverine species.

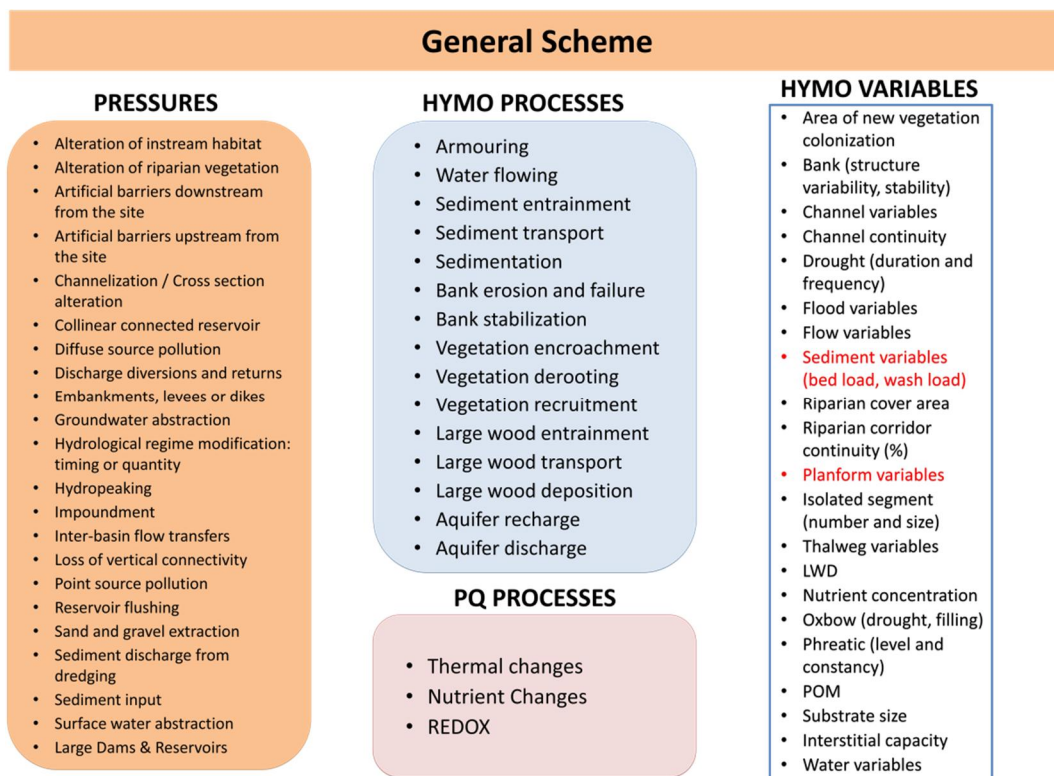

Figure 1. Hydromorphological pressures that have been reviewed for their impact on HyMo processes.

- A review of case studies and literature on costs and benefits of river restoration in Europe showed that cost data are quite variable and usually not available in a form appropriate for further assessments (Ayres et al. 2014). Thus, investing efforts in

standards and protocols to gather and incorporate cost information in a more systematic way will benefit decision-making.

- In assessing hydromorphology to date there has been too strong a reliance on the reach scale. For sustainable solutions, it is crucial to develop understanding of the functioning of river reaches in the wider spatial context. The ways in which river reaches have responded to changes in the past, provide crucial information for forecasting how reaches may change in the future. The REFORM framework allows users to incorporate all of these multi-scale spatial and temporal aspects into river assessment and management (Gurnell et al. 2014a).

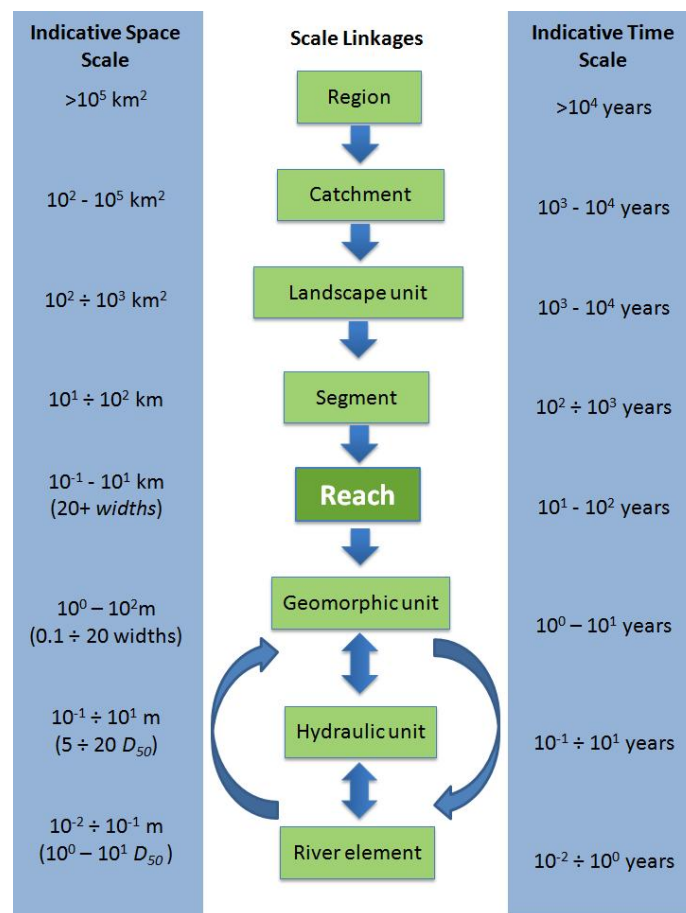

Figure 2. Hierarchy of spatial scales for the European Framework for hydromorphology, including indicative spatial dimensions and timescales over which these units are likely to persist.

- Riparian vegetation is not included as a biological quality element in the Water Framework Directive. Gurnell et al. (2014b) present new science concepts and analyses that clearly demonstrate the importance of riparian and aquatic vegetation as a key physical control on river form and dynamics and a crucial component of river restoration.
- Existing metrics have been evaluated for their strength to distinguish the impact of HYMO pressure on the mandatory biological quality elements from other stressors (Friberg et al 2013). This showed that there is potential to develop metrics from

monitoring data on fish and macrophytes to indicate HYMO impacts. Contrarily, relationships between HYMO degradation and macroinvertebrate metrics were weak.

- Despite the rapid increase in river restoration projects, little is known about the effectiveness of these efforts and many practitioners do not follow a systematic approach for planning restoration projects. REFORM has developed a planning protocol that incorporates benchmarking and setting specific and measurable targets for restoration and mitigation measures (Cowx et al. 2013).
- Existing data on the effect of restoration on biota complemented by information on factors which potentially enhance or constrain this were analysed (Kail & Angelopoulos 2014). Overall, restoration success did most strongly depend on project age and river width, and was affected by agricultural land use. Restoration still had a positive effect in catchments dominated by agricultural land use, and thus do not question the implementation of restoration projects in intensively used catchments. The influence of project age stresses the need for long-time monitoring to investigate the restoration effect over time.

Expected final results and their potential impact and use

From analysis of the first round of RBMPs, it is clear that the hydrology in many river basins and the morphology of streams, rivers, riparian zones and floodplains have been modified to serve social and economic needs (flood protection, water supply for agriculture, households and industries, navigation, hydropower). The ecological impact is poorly understood. To remediate this EU Member States have set up programmes of measures to improve the ecological status of their water bodies. REFORM is the first European research project to have a strong emphasis on supporting the knowledge base for the programmes of measures, i.e. how to restore our rivers. Reflecting the foreseen outcome of REFORM with the main topics raised during its stakeholder workshop in February 2013 clearly highlighted the potential use of its results. REFORM has contributed by improving our scientific understanding of the linkages between hydromorphology and ecological status, but moreover by making its results available in various forms to support both practitioners and scientists.

Besides expanding the knowledge base, there is also an urgent need to share experiences. Web-based knowledge information systems are an effective means to share the know-how from practical experience and connect this with the scientific knowledge. Consequently REFORM has developed a WIKI that has been populated throughout the course of the project with information relevant for various phases of River Basin Management Planning (characterisation of basins and water bodies, objectives, impacts of hydromorphological pressures, programmes of restoration measures) to meet this need (Figure 3). Complementary, the LIFE+ project RESTORE has generated the largest European database on stream and river restoration projects (<https://restorerivers.eu/wiki>).

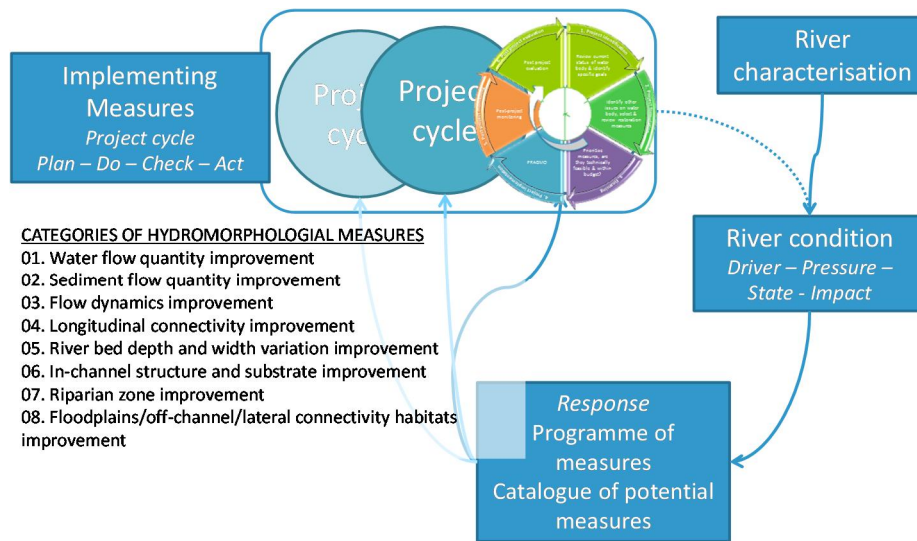

Figure 3. In the online WIKI the results of REFORM's are presented in the implementation cycle of River Basin Management Plans.

Practitioners will benefit from the tools for improved monitoring of the impact of HYMO pressures and for better planning and evaluating of restoration. They will also benefit from the WIKI, which is a more effective way to trace relevant information on these topics than currently available. On the other hand, scientists benefit from a wide range of scientific publications regarding the role of scale and processes to shape rivers and streams by hydromorphology and vegetation, to discern the impact of hydromorphological pressures on biota from other stressors, the extent to which scale matters for restoration, and answers to the question how restoration could become more effective in all phases of project realisation cycles.

References

Ayres et al. (2014) Inventory of river restoration measures: effects, costs and benefits. REFORM deliverable 1.4. <http://www.reformrivers.eu/deliverables/d1-4>

Cowx et al. (2013) Measuring success of river restoration actions using end-points and benchmarking. REFORM deliverable 5.1. <http://www.reformrivers.eu/results/restoration-potential-and-strategy>

Friberg, O'Hare & Baatrup-Poulsen [eds.] (2013). Impacts of hydromorphological degradation and disturbed sediment dynamics on ecological status. REFORM deliverable 3.1. <http://www.reformrivers.eu/results/effects-of-hydromorphological-changes>

Garcia de Jalon et al. (2013) Review on pressure effects on hydromorphological variables and ecologically relevant processes. REFORM deliverable 1.2. <http://www.reformrivers.eu/deliverables/d1-2>

Gurnell et al. (2014a) Multi-scale framework and indicators of hydromorphological processes and forms I. Main report. REFORM deliverable 2.1 part 1 <http://www.reformrivers.eu/results/hydromorphological-processes>

Gurnell et al. (2014b) Influence of Natural Hydromorphological Dynamics on Biota and Ecosystem Function, Part 1. REFORM deliverable 2.2 part 1 <http://www.reformrivers.eu/results/hydromorphological-processes>

Kail & Angelopoulos (2014). Evaluation of hydromorphological restoration from existing data. REFORM deliverable 4.2. <http://www.reformrivers.eu/results/effects-of-river-restoration>

Mosselman et al. (2013) Synthesis of interim results for practical application to support the compilation of the 2nd RBMPs. REFORM deliverable 6.1. <http://www.reformrivers.eu/results/applications-and-tools>

Wolter et al. (2013) Review on ecological response to hydromorphological degradation and restoration. REFORM deliverable 1.3. <http://www.reformrivers.eu/deliverables/d1-3>

Measuring restoration success

Cowx I G & Angelopoulos N

IAN COWX & NATALIE ANGELOPOULOS

Hull International Fisheries Institute. School of Biological, Biomedical and Environmental Sciences, University of Hull, Hull, UK.

i.g.cowx@hull.ac.uk

Abstract

Despite the rapid increase in river restoration projects, there is a paucity of information about the effectiveness of these restoration efforts because often they are not fully evaluated in terms of success or reasons for success or failure. A review of concepts to measure the success of river restoration found that despite large economic investments in what has been called the "restoration economy", many practitioners do not follow a systematic approach for planning restoration projects. As a result, many restoration efforts fail or fall short of their objectives, if objectives have been explicitly formulated. This largely arises because a fundamental lack of understanding of the planning, design and implementation stage of rehabilitation schemes.

The aims of restoration activities in Europe are influenced by a plethora of EU Directives and national government policies that have conflicting targets. Current river restoration tends to encounter obstacles as a result of societal demands, particularly through a select number of ecosystem services, such as provisioning and regulating services like flood protection, hydropower, navigation and agriculture. Recent developments have resulted in directives such as Floods Directive (FD (2007/60/EC)) and Renewable Energy Directive (RED (2009/28/EC)), these are directives and legislation that are potentially at conflict with the Water Framework Directive (WFD (2000/60/EC)), but are necessary to support river management from the social and economic perspectives. As a consequence, managers are required to change the way European inland waters are conserved.

Here we discuss common problems or reasons for failure and the potential for restoring river ecosystems to optimise benefits accrued for biodiversity and ecosystem services, whilst considering climate change effects on the ability to deliver these outcomes. A planning framework is proposed that systematically guides practitioners through two main planning stages of river restoration 1) catchment scale & 2) project cycle. The framework identifies a number of tools and guidelines for best practice to measure performance and determine appropriate targets for river restoration, some of which have been developed in REFORM.

Introduction

Despite the rapid increase in river restoration projects, there is a paucity of information about the effectiveness of these restoration efforts because often they are not fully evaluated in terms of success or reasons for success or failure. A review of concepts (Cowx et al. 2013) to measure the success of river restoration found that despite large economic investments in what has been called the "restoration economy", many practitioners do not follow a systematic approach for planning restoration projects. As a result, many restoration efforts fail or fall short of their objectives, if objectives have

been explicitly formulated. This often appears not to be the case. Some of the most common problems or reasons for failure include:

- Not addressing the root cause of habitat degradation
- Upstream processes or downstream barriers to connectivity and habitat degradation that affect ecosystem functioning
- Not establishing reference condition benchmarks and success evaluation endpoints against which to measure success
- Failure to get adequate support from public and private organizations
- No or an inconsistent approach for sequencing or prioritizing projects
- Poor or improper project design
- Inappropriate use of common restoration techniques because of lack of pre-planning (one size fits all)
- Inadequate monitoring or appraisal of restoration projects to determine project effectiveness
- Improper evaluation of project outcomes (real cost benefit analysis)

A review of 671 European case studies collated for REFORM WP1 Deliverable 1.3 (Wolter et al. 2013) found only a small number of case studies reported ecological success or failure: many were either unclear in their findings, the restoration works were not monitored or no information was provided (Figure 1). Only 52% had been monitored and of these only 3% recorded physio-chemical success, 8% morphological success and 17% biological success. This remarkably low adherence to what would seem good project management practice is possibly attributable limited guidance for evaluating the success of restoration projects.

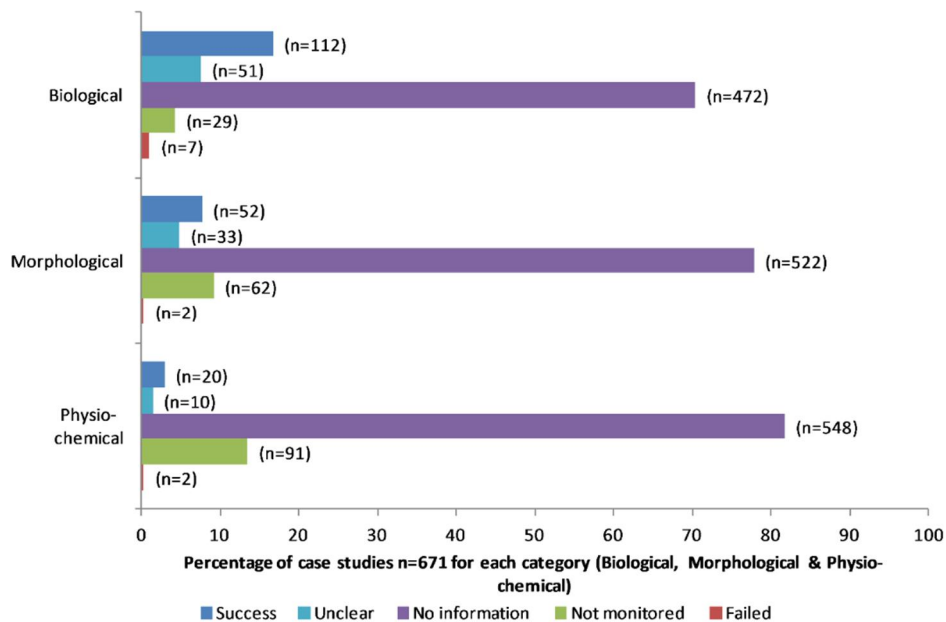

Figure 1. Success rate of 671 European case studies recorded from the REFORM WP1 database.

Efforts to develop metrics of biological quality to support the WFD have been considerable (Hering et al. 2010). Quality thresholds of ecological standards are rated by

the response of ecological communities to human pressures along a five-point ecological status scale defined as 'high', 'good', 'moderate', 'poor' or 'bad' pressures but to a perceived reference of pristine, irrespective of the pressure (Irvine 2012). However, this is somewhat problematic as the judgment of restoration success can vary between stakeholders, particularly as different disciplines have different aspirations of project success (Howe & Milner-Gulland 2012; Jones 2012). Within this there is a need to account for natural spatial and temporal variability in the response of ecological communities to environment change (Howarth 2006; Hatton-Ellis 2008; Moss 2008).

Multiple pressures & climate change

In addition to determining the outcomes of restoration activities, global effects of climate change are becoming increasingly prevalent (IPCC 2007) and are expected to have a major impact on water resources in Europe. It is predicted that climate change will increase the occurrence of extreme events (i.e. flood and droughts) and will therefore have a strong influence on habitats, communities, species and individual organisms in the future (FSBI 2007). There are a number of European Directives to support the ecological health of rivers such as the WFD, Habitats Directive (HD (92/43/EEC)) and Groundwater Directive (GWD (2006/118/EC)), in addition to global initiatives such as Agenda 21 of the Rio Convention and the Convention of Biological Diversity. These have driven the management of inland waters towards rehabilitation of rivers and lakes to improve the aquatic environment for biodiversity and allow for sustainable exploitation of the resources (Eden & Tunstall 2006; Pasternack 2008; Hobbs et al. 2011). Consequently, nature conservation, and in particular river restoration, are increasingly considered as part of a much wider framework of environmental policy and practice (Arlinghaus et al. 2002). Nevertheless, the aims of restoration activities in Europe are influenced by a plethora of EU Directives and national government policies that have conflicting objectives. Current river restoration tends to encounter obstacles as a result of societal demands, particularly through a select number of ecosystem services, such as provisioning and regulating services like flood protection, hydropower, navigation and agriculture. Recent developments have resulted in directives such as Floods Directive (FD (2007/60/EC)) and Renewable Energy Directive (RED (2009/28/EC)) and other legislation that are potentially at conflict with the WFD, but are necessary to support river management from the social and economic perspectives. As a consequence, managers are required to change the way European waters are conserved, especially as the ecological classification under the WFD may change with climate-induced effects and therefore, cannot be considered as static (Bernasconia et al. 2005). Including externalities, such as pressures from societal demands and climate change, in to the early stages of river restoration planning is imperative for project success.

Identifying targets to measure restoration success

One of the first steps for best practice and procedures for measuring performance and determining appropriate targets for restoration activities is to establish benchmark conditions against which to target restoration measures. This requires i) assessment of catchment status and identifying restoration needs before selecting appropriate restoration actions to address those needs, ii) identifying a prioritization strategy for appropriate cost effective actions, iii) developing a monitoring and evaluation programme, and iv) participation and fully consultation of stakeholders. The third topic requires that objectives of the restoration programme are established against which the

success can be measured. These targets or endpoints of any restoration project should be specific, measurable, attainable, relevant and timely. Setting benchmarks and endpoints that are linked to clearly defined project goals is considered the best approach to help determine the measure of success, especially when goals are linked to objective success criteria to guide the process and the likelihood of achieving the end result (Bernhard et al. 2007). Benchmarks and endpoints place a level of quality to rehabilitation that can be used as a standard when comparing other things against which to measure performance. They should be reviewed against reference conditions, to determine appropriate targets for restoration, rehabilitation and mitigation activities. However, river restoration, rehabilitation and mitigation require several areas of knowledge such as ecology, hydrology and engineering (Doyle et al. 1999) and goals relating to composition, structure, function and other ecological parameters, thus it is complex and considered difficult to define which measures should be used to quantify the success (Hobbs & Harris 2001). The meaning of 'success' will change depending on the type of water body, type of project, the condition of the river health and the ecosystem services it supplies. Identifying project success largely depends on a good understanding of the planning, design and implementation stage of rehabilitation schemes.

Integrated project planning framework

REFORM has developed an integrated project planning framework in WP5.1 for restoration project planning that incorporates benchmarking and setting specific and measurable targets for restoration and mitigation measures (Figure 2). The restoration planning approach developed uses project management techniques to solve problems and produce a strategy for the execution of appropriate projects to meet specific environmental and social objectives. It provides knowledge of the technical policy and background to conflicts of multiple users of resources and develops a plan for comparison of status with objectives. Such restoration planning should become an integral part of the river basin management, and full consultation with all user groups is essential to promote optimal, sustainable use of the water body whilst meeting WFD targets. The framework systematically guides practitioners through two main planning stages of river restoration 1) catchment scale & 2) project cycle, enabling users to put project specific restoration into a RBMP context. It provides detailed information for each of the planning stages and offers tools and guidelines for users, some of which have been developed in REFORM. These include Plan Check Do Act (PDCA), Driver Pressure State Impact Response (DPSIR), Logical Project Framework, SMART objectives (Specific Measurable Achievable Realistic Timely), endpoint & benchmarking, Multi Criteria Decision Analysis (MCDA) and Cost Benefit Analysis (CBA).

Adopting an integrated project planning framework for river restoration, such as that linked to the REFORM project, will reduce the uncertainty of management actions by providing:

- 1) A project planning cycle at a catchment scale, guiding the user through a logical path to design projects linking policy, watershed/catchment assessment, restoration goals, monitoring & evaluation schemes and selection & prioritisation.
- 2) Concise structured information for each stage of the project cycle, relating this to RBMPs and PoMs.

- 3) Concise structured information for each stage of the project cycle at a project specific scale and to identify specific measures.
- 4) Easy access to relevant tools & guidelines that can be used at different stages of the planning process.
- 5) The choice of more detailed information where needed, giving the option of a more complex planning framework – here the tools from REFORM WPs will be incorporated.

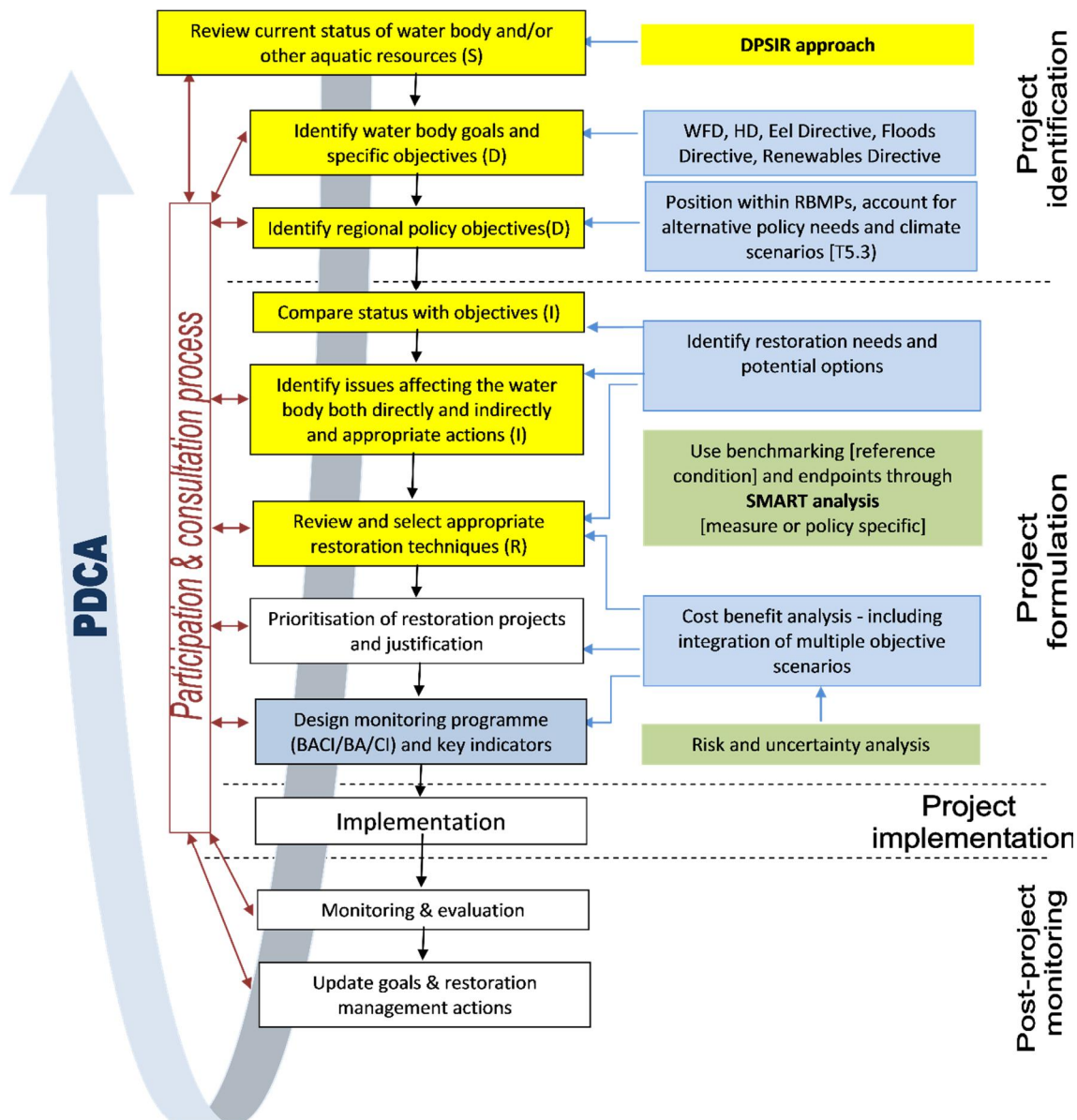

Figure 2. Proposed planning protocol for restoration projects - yellow coloured boxes represent steps in the DPSIR approach to management intervention.

All information will be accessible via the interactive REFORM WIKI. Project planning at a catchment scale will ensure river restoration objectives are set to improve ecological status at a river basin level through the PoMs and will be defined by institutional, regional

and national policy. Therefore, subsequent decisions for smaller, local scale river restoration will still benefit at a larger catchment scale.

References

- Arlinghaus R, Mehner T. & Cowx I.G. 2002. Reconciling traditional inland fisheries management and sustainability in industrialised countries, with emphasis on Europe. *Fish and Fisheries* 3, 261–316.
- Bernasconi C, Campostrini P, De Roo A, George G, Heiskanen A.S, Hjorth J, Hoepffner N, Jones K.C, Noges P, Pirrone N, Runnalls N, Somma F, Stilanakis N, Umlauf G, van de Bund W, Viaroli P, Vogt J & Zaldivar J.M. 2005. Climate change and the European Water Dimension. European Commission Joint Research Centre. EUR 21553.
- Bernhardt E.S. & Palmer M.A. 2007. Restoring streams in an urbanizing world. *Freshwater Biology* 52, 738–751.
- Cowx I.G, Angelopoulos N, Noble R, Slawson D, Buijse T. & Wolter C. (2013). Measuring success of river restoration actions using end-points and benchmarking. REFORM D5.1.
- Doyle M.W, Miller D.E. & Harbor J.M. 1999. Should River Restoration Be Based on Classification Schemes or Process Models? Insights from the History of Geomorphology. ASCE International Conference on Water Resources Engineering, Seattle, Washington.
- Eden S. & Tunstall S. 2006. Ecological versus social restoration? How urban river restoration challenges but also fails to challenge the science - policy nexus in the United Kingdom. *Environment and Planning C: Government and Policy* 24, 661-680.
- FSBI. 2007. Climate Change and the Fishes of Britain and Ireland: Briefing Paper 4 Sawston, Cambridge, UK: Fisheries Society of the British Isles.
- Hatton-Ellis T. 2008. The hitchhiker's guide to the Water Framework Directive. Aquatic Conservation: *Marine and Freshwater Systems* 18, 111–116.
- Hering D, Borja A, Carstensen J, Carvalho L, Elliott M, Feld CK, Heiskanen A-S, Johnson R.K, Moe J. & Pont D. 2010. The European Water Framework Directive at the age of 10: a critical review of the achievements with recommendations for the future. *Science of the Total Environment* 408, 4007–4019.
- Hobbs R.J. & Harris J.A. 2001. Restoration Ecology: Repairing the Earth's Ecosystems in the New Millennium. *Restoration Ecology Vol. 9(2)*, 239–246.
- Hobbs R.J, Hallett L.M, Ehrlich P.R. & Mooney H.A. 2011. Intervention Ecology: Applying Ecological Science in the Twenty-first Century. *BioScience* 61(6), 442-450.
- Hobbs R.J, Hallett L.M, Ehrlich P.R. & Mooney H.A. 2011. Intervention Ecology: Applying Ecological Science in the Twenty-first Century. *BioScience* 61(6), 442-450.
- Howe C. & Milner-Gulland E. J. 2012. Evaluating indices of conservation success: a comparative analysis of outcome- and output-based indices. *Animal Conservation* 15, 217–226.
- Irvine K. 2012. The tragedy of the threshold: revising perceptions for aquatic conservation. *Aquatic Conservation of Marine and Freshwater Ecosystems* 22, 705–711.
- Jones J.P.G. 2012. Getting what you pay for: the challenge of measuring success in conservation. Commentary. *Animal Conservation* 15, 227–228.
- Moss B. 2008. The Water Framework Directive: total environment or political compromise? *Science of the Total Environment* 400, 32–41.
- Pasternack G.B. 2008. Spawning Habitat Rehabilitation: Advances in Analysis Tools. *American Fisheries Society Symposium* 65, 321-348.
- Wolter C, Lorenz S, Scheunig S, Lehmann N, Schomaker L. & Nastase A. 2013. Review on ecological response to hydromorphological degradation and restoration, Reform Deliverable D 1.3.

Between a rock and a hard place: ecological responses to degraded hydromorphology in rivers

Friberg N et al.

NIKOLAI FRIBERG¹, HANNEKE KEIZER-VLEK², PIET VERDONSCHOT², MATTHEW O'HARE³

¹*Norwegian Institute for Water Research. Gaustadalléen 21, NO-0349 OSLO, Norway.*

²*Alterra Wageningen UR. Subdivision, Alterra - Animal ecology. Post address, PO Box 47. 6700AA WAGENINGEN, the Netherlands.*

³*NERC Centre for Ecology and Hydrology, Bush Estate, Penicuik, Edinburgh, Midlothian, EH26 0QB, U.K.*

Abstract

Degraded hydromorphology are one the most extensive impacts on river ecosystems in Europe today. Centuries of modification by man to ensure drainage, flood protection, navigation and hydropower has completely altered habitat area, channel form and processes in rivers and floodplains almost everywhere. In parallel, these systems were impacted by a number of other very deteriorating stressors, primarily sewage influx and land-use intensification. As a result of this sum of stressors, the ecological status of rivers was very impaired and they are still globally among the ecosystems that have seen the greatest loss of biodiversity. While the effects of stressors such as low oxygen levels on the river biota are well documented and has been instrumental in reducing sewage loads, specific methods to assess the impact of degraded hydromorphology on ecological status are relatively uncommon. A large scale analysis of existing data sets across Europe showed in general weak relationships between identity-based ecological indicators and measures of hydromorphological quality. However, relationships were dependent of sampling methods and to some degree scaled with organism size, with fish showing most promise. These relationships were further improved when using species traits (also using macrophytes) that are more closely linked to the habitat template, including hydromorphology. When using controlled experiments at small scales the impacts of hydromorphology and fine sediments become more clear-cut also for macroinvertebrates. Moreover, previous detailed field studies have shown that habitats that are assessed as being similar can differ markedly with regard to biota and that suitable habitats might not be colonized due to dispersal limitations. These findings suggest that scales of sampling are a core issue in assessing the influence of degraded hydromorphology and that methods using species traits of large(r) organisms are likely to be the most sensitive. However, the focus on in-stream biota that is routinely monitored ignores that many of the pronounced effects of degraded hydromorphology relates to the riparian zones and the wider floodplain. Especially riparian zones are important as they influence in-stream processes as well as providing a very diverse habitat for both aquatic and terrestrial organisms. Overall, findings suggest that direct measurements of hydromorphological processes and riparian vegetation are likely to be better in assessing hydromorphological degradation than in-stream biota.

Introduction

Natural rivers depend on catchment scale structural controls, reach scale channel pattern differences and micro-scale variations in channel bed forms, all of which vary over different time scales (Friberg, 2014; figure 1). In this hierarchical organization, structure and processes occurring on small spatial and temporal scales are nested within increasingly larger scales, from microhabitat to catchment. Naturally, therefore, the impact of management will be scale dependent and linked to the spatial and temporal heterogeneity provided by natural stream reaches, which creates a range of biotopes for the biota and is the scale where impact is assessed (Frissell et al. 1986). Moreover, lotic ecosystems will be impacted at a range of scales depending on the type of pressure, with larger scale impacts having negative effects on lower levels of organization.

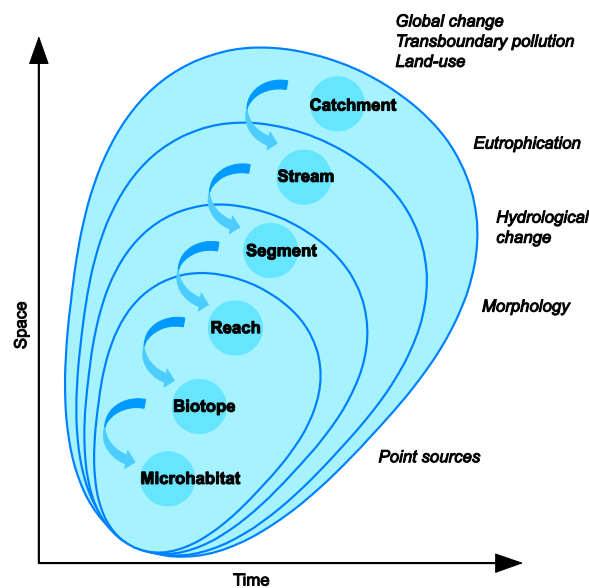

Figure 1. Showing the nested structure of river ecosystems and the scale dependence of pressures (from Friberg 2014).

Degradation and loss of physical complexity in lotic ecosystems have been massive in most parts of the Europe through, for instance, channelization, dredging and wood removal etc. (Friberg, 2010). In addition, siltation with fine sediments is a major problem in many streams, especially in agricultural catchments (Glendell et al. 2014). The importance of habitat heterogeneity for biota is indisputable but surprisingly few studies have documented clear impacts of habitat degradation (Friberg, 2014). Several recent studies have revealed weak relationships between a standardised measure of habitat quality (River Habitat Survey (RHS)) and a number of macroinvertebrate indices in streams along a hydromorphological degradation gradient (e.g. Vaughan et al., 2009).

In this paper, we present the outcome of some analyses made as part of the REFORM WP3 and put it in the context of existing knowledge. The questions we address are 1) can we track the importance of hydromorphology in existing monitoring data sets using the range of BQEs? 2) which are the better BQE to detect HYMO stress? 3) will using species traits improve the sensitivity towards HYMO? 4) what can be learned from experiments

and more detailed field studies on the linkages between HYMO and biota? 5) what are the effects of HYMO degradation of the riparian ecosystems?

Most of data and analyses are drawn from the four deliverables that constitute the formal output of REFORM WP3 (D3.1; D3.2; D3.3; D3.4). Other studies will be cited when used.

Results and discussion

No strong relationships between HYMO stress and more than 200 different existing macroinvertebrate metrics and indices were found. Metrics developed to detect hydrological impairment and hydromorphological degradation were not more discriminative. Some of the strongest relationships identified were between macroinvertebrate metrics that measure the presence of taxa with a preference for specific flow or substrate type conditions and between indicators of these specific conditions, which reflects the potential of using trait-based metrics to evaluate hydromorphological conditions. However, a subsequent analysis revealed few traits in macroinvertebrates that potentially could distinguish between HYMO and other stressors. In contrast to the findings using the larger monitoring data sets, experimental studies showed that both substrate patchiness and coverage with fine sediments influenced macroinvertebrate populations. The reasons for the lack of sensitivity can most likely be attributed to a number of explanatory variables not being measured as part of routine monitoring programmes or in the currently used hydromorphological assessment schemes, which do not necessarily register elements of importance to the in-stream biota. A detailed field study have shown that riffle habitats that are visually assessed as being identical can differ markedly with regard to macroinvertebrate diversity and community composition (Pedersen & Friberg, 2007). Furthermore, local environmental conditions are not the sole determinant of macroinvertebrate (or other biological elements) community composition as both local biotic interactions (Woodward, 2009) and larger dispersal mechanisms (Heino, 2013) play an important structuring role. Evaluation of restoration projects, using a space-for-time substitution approach, showed that despite plenty of suitable habitat macroinvertebrate diversity was still lower than in reference streams that had never been significantly modified (Pedersen et al., 2004).

No effects of hydromorphological degradation on indices based on phytobenthos were detected from analysis on a large scale data set. However, indices developed to assess eutrophication stress (e.g. TDI, IPS and related indices) appear robust to hydromorphological alteration. With regard to fine sediment stress specifically, analysis of a spatial data set showed a strong relationship between fine sediment and the diatom community composition, which might suggest that diatoms could be used as an indicator to fine sediment stress. In contrast to this finding and more in support of general analysis of the response to HYMO stress, phytobenthos community composition was primarily impacted by soluble reactive phosphorous concentration in experiments. Fine sediment treatment did not significantly impact on either chlorophyll-a concentrations or ash free dry weight (AFDM), suggesting that algal growth was unaffected.

Macrophyte trait characteristics changed significantly in response to hydromorphological degradation in small streams. Several traits could be identified such as species growing from single basal meristems declined and that species with a high overwintering capacity increased. However, with one exception, the trait heterophylly (the ability to have

different types of leaves above and below water), impacts of HYMO stress could not be separated from eutrophication. More traits were specific to eutrophication, which could aid in the diagnostic of main stressors in multiple stress systems. Although macrophytes are very important in some river types, they have limited applicability as a general indicator for the range of European river types. For lowland streams they could possibly be used if a trait based metric was developed.

Results from the analyses of a large scale European data set showed that 49% of the studied European freshwater species show a significant response to HYMO stress. Using conceptual models that link pressures via processes to responses it was identified that benthic fish like Cobitidae, Nemacheilidae, Cottidae or Gobiidae showed the most consistent response to HYMO stress. This response can be related to their dependence on substrate dynamics and low mobility. Conceptual models should be viewed as a first step, and although more traditional metric approaches using fish also has significant potential, both approaches requires significant development before than can be applied in regular monitoring. The inherent difficulty in fish methods based on number of taxa is that their use is restricted to stream/river types with a minimum of species diversity, leaving out most small streams. In these types more detailed investigations on length frequency distributions can be related to HYMO stress. Many HYMO pressures (but also non-HYMO pressures) generate a clear response in the fish community size structures, particularly inducing changes in the overall shape of the size spectra, which might therefore be useful as a new potential metric for assessing impacts of HYMO stress.

These findings leave water managers with a significant challenge when diagnosing the reason for not obtaining good ecological status in a waterbody. Even for fish, the BOE which showed most promise, there is a significant amount of work to do before sensitive metrics to HYMO stress can be applied in water management. The issue with the impact of multiple stressors on the biota has been shown to preclude our ability to disentangle HYMO stress from other stressors. It appears from the analysis undertaken that e.g. eutrophication is a stronger driver of community changes. This is, however, most likely also related to the quality of the HYMO assessments, which in most of the larger data sets were fairly superficial. Another inherent problem is that dispersal mechanisms are likely to be highly influential on especially colonisation of physical features and biotopes. An extensive review of metacommunity research suggests that biotic interactions and dispersal-related effects play an important role in structuring communities (Heino, 2013). This can probably in many cases de-couple any direct link between local hydromorphology and biota. Moreover, the focus on in-stream biota that is routinely monitored ignores that many of the pronounced effects of degraded hydromorphology relates to the riparian zones and the wider floodplain. Especially riparian zones are important as they influence in-stream processes as well as providing a very diverse habitat for both aquatic and terrestrial organisms. Overall, findings suggest that direct measurements of hydromorphological processes and riparian vegetation are likely to be better in assessing hydromorphological degradation than in-stream biota.

Acknowledgements

The WP3 work was done by a large group of dedicated scientist that is named on the individual deliverables.

References

- Friberg N. 2010. Ecological consequences of river channel management In: *Handbook of catchment management* (Eds. R.C. Ferrier & A. Jenkins). Wiley-Blackwell, Chichester, UK, 77-106.
- Friberg N. 2014. Impacts and indicators of change in lotic ecosystem. *Wiley Interdisciplinary Reviews: Water* 1, 513-531.
- Frissell CA, Liss WJ, Warren CE & Hurley MD. 1986. A hierarchical framework for stream habitat classification: viewing streams in a watershed context. *Environmental Management* 12: 199–214.
- Glendell M, Extence C, Chadd R & Brazier RE. 2014. Testing the pressure-specific invertebrate index (PSI) as a tool for determining ecological relevant targets for reducing sedimentation in streams. *Freshwater Biology* 59: 353-367.
- Heino J. 2013. The importance of metacommunity ecology for environmental assessment research in the freshwater realm. *Biological Reviews* 88: 166-178.
- Pedersen ML., Kristensen KK & Friberg N. 2014. Re-meandering of lowland streams: Will disobeying the Laws of geomorphology have ecological consequences? *PLOS ONE* <http://dx.plos.org/10.1371/journal.pone.0108558>.
- Pedersen M.L. & Friberg N. 2007. Spatio-temporal variations in substratum stability and macroinvertebrates in lowland stream riffles. *Aquatic Ecology* 41: 475-490.
- Vaughan IP, Diamond M, Gurnell AM, Hall KA, Jenkins A, Milner NJ, Naylor LA, Sear DA, Woodward G & Ormerod SJ. 2009. Integrating ecology with hydromorphology: a priority for river science and management. *Aquatic Conservation: Marine and Freshwater Ecosystems* 19, 113-125.
- Woodward G. 2009. Biodiversity, ecosystem functioning and food webs in fresh waters: assembling the jigsaw puzzle. *Freshwater Biology* 54, 2171-2187.

Anticipating future trajectories of floodplain rivers and human systems in river restoration

Gregory S

STAN GREGORY

*Department of Fisheries & Wildlife, Oregon State University,
Corvallis, OR 97330, USA.*

Abstract

The central focus of river restoration inescapably must be the river. River managers sometimes attempt to serve social needs and create relatively static river ecosystems, designing the channel, floodplain, and riparian plant communities to remain unchanging. In contrast, river restoration can be viewed as a river--- dynamic and changing--- reflecting the structure and processes along the river network. One of the greatest challenges in river restoration is anticipating the future. Human populations, land uses, and climate inevitably change and ultimately create a new river. In the Willamette River in Oregon, USA, river channels have been simplified, floodplain forests reduced, and sediment delivery and flood magnitude decreased. Diversity and abundance of native fish communities decrease along the length of the mainstem river. Regional partners have created an explicit spatial framework for 1) design and selection of restoration efforts and 2) monitoring and assessment of future trajectories in the river and its communities. The partners are creating a network of communities and restoration practitioners to 1) restore a geomorphically dynamic river, 2) facilitate ecological recovery, 3) meet social expectations, and 4) anticipate the future of the river and its human communities.

Introduction

The central focus of river restoration inescapably must be the river. River managers sometimes attempt to serve social needs and create relatively static, unchanging river ecosystems. Such efforts are well intended but inherently diminish the processes that shape the channel, floodplain, riparian plant communities, and aquatic ecosystems. Simplifying and hardening the river inadvertently increase the erosive power of the river and place valuable human property at risk as communities build closer to the river. Dams and weirs alter the movement of both water, sediment, and living aquatic organisms.

In this presentation, I will define restoration is the design of a more ecologically sound and livable future. This approach to restoration requires anticipation of future conditions, not only for biophysical properties of the river network but also for the human communities that depend on the rivers. Almost all cities and towns depend on the rivers and lakes in the heart of their communities. Existing patterns are assumed to be immutable and future development is considered case by case for isolated places along the rivers and only for the immediate issues of concern to the community. Incrementally, natural resource legacies are nibbled away decision by decision, and memories of past resource conditions and community values are dismissed a vague or irrelevant. Alternative future scenarios can be mapped in spatially explicit projections and analyzed quantitatively to bound the extent and implications of future change.

Anticipation of future river channels and riparian plant communities is equally important, challenging, and often ignored. Human systems alter the natural hydrogeomorphic processes and riparian plant colonization and succession that shape the river channel and floodplain and provide habitat for both terrestrial and aquatic communities. Dams, weirs, and other obstructions alter hydrologic regimes and diminish the movement of sediments, nutrients, and fish and other aquatic organisms. One of the most difficult and often ignored challenges of river management is anticipating the river of the future rather than managing for the present yet changing river.

Methods

I will describe on-going efforts in the Willamette River in Oregon, USA as an example of the application of alternative futures analysis within a framework for river restoration. Trajectories of past and future change in natural resources and human communities of the Willamette River basin were quantified in joint research of the U.S. Environmental Protection Agency, Oregon State University, and University of Oregon (Baker et al. 2004, Hulse et al. 2002). Three future alternatives were considered: 1) Plan Trend, which represent current practices and policies, 2) Development, which represents a relaxation of current land use regulations, and 3) Conservation, which represents plausible increases in conservation practices and regulations. These projections of future conservation and restoration opportunities were developed with stakeholders, analyzed through landscape models, and currently serve as a scientific framework for the design and review of restoration actions in the Willamette River (Willamette River Basin Planning Atlas http://www.fsl.orst.edu/pnwerc/wrb/Atlas_web_compressed/PDFtoc.html).

Effective planning and monitoring requires a spatial framework for river restoration that is consistent with the hydrogeomorphic and biological processes that maintain and restore rivers. We developed a SLICES framework as a spatial context for the mainstem Willamette River (Hulse and Gregory 2004; <http://ise.uoregon.edu/slices/Main.html>). This provided a spatial framework to track ecological conditions along the river and its floodplain while allowing the river channel to shift through time without altering the analytical baseline context. The mainstem Willamette River was divided into 300 1-km sections (SLICES) that are perpendicular to the axis of the floodplain and extend to the outer boundaries of the historical floodplain. The SLICES framework provides the basis for environmental and biophysical monitoring, restoration design, and public outreach and education.

We divided the mainstem Willamette River into three sections from its mouth upstream 301 km to the confluence of the Coast and Middle Fork Willamette based on analysis of river geomorphology (Gregory et al., 2002b; Wallick et al., 2013). The SLICES framework served as the geomorphic basis of randomized site selection for fish community assessment. Each 1-km slice of the mainstem river or floodplain slough within a river slice represented a single sampling location. In each 1-km slice in 2011-2013, fish were captured with standardized boat and backpack electrofishing in 96 mainstem reaches and 71 sloughs. Environmental and habitat characteristics were measured at each site. In addition, eight long-term water quality monitoring sites are maintained by Oregon Department of Environmental Quality along the length of the mainstem Willamette River.

Results

From 1850 to the present, the channel of the Willamette River has been simplified (Gregory 2008). Since 1850, 63% of islands, 56% of side channels, and 22% of active channel area has been lost by land conversion and river channel management. Over that period, floodplain forests have been reduced to 10% of their historical area. In 1850, forests covered 88% of the length of the active channel, but now are found along only 40% of the length of the mainstem. Flood control reservoirs in the tributaries of the Willamette River have reduced sediment delivery by 60% (Jim O'Connor, USGS, personal communication). Presently, the mainstem river is less heterogeneous, exhibits greater depth, and has less extensive floodplains in the lower reach. In addition, human population density in urban areas is greater in the lower river. Water quality historically has been more severely degraded in the lower reach of the mainstem Willamette River, but the Water Quality Index has been improving in recent decades (ODEQ).

The population of the Willamette River basin is projected to double from 2000 to 2050, and the analysis of the Plan Trend alternative indicated that most natural resources would experience continued decline though less than historical losses (Fig. 1). The Development alternative indicated even greater loss of natural resources, especially for wildlife habitat. Surprisingly, the Conservation scenario indicated that most natural resources would reverse the trajectory of decline and recover 20-40% of the natural resources that had been lost historically, in spite of a doubling of the human population. The Conservation scenario has been adopted by state and NGO partners as a Conservation and Restoration Opportunities baseline for future restoration. It is included in the SLICES framework as a metric of status and trends toward a commonly accepted guiding vision of attainable future restoration.

One of the key biological indicators for the Willamette River is the fish community, which includes both native fish species and non-native fish that have been introduced either intentionally or accidentally. During the 2011-2013 monitoring program, we identified 41 fish species, 22 native and 19 non-native. Of the total of 36,586 individual fish collected, 93% were native species and 7% non-native. In mainstem habitat, 97% of the individual fish captured were native and 3% were non-native. A greater proportion of catch in slough habitats was non-native (13%), but native species comprised the majority (87%) of fish captured in the sloughs as well.

Species richness and relative abundance of fish exhibited significant longitudinal patterns (Fig. 1). Higher numbers of fish were collected in the upper river, and higher proportions of those fish were native species. From the upper reach to the lower reach as a whole, native species dominated in terms of relative abundance (96%, 89%, 81%) and total number of taxa (20, 19, 14). In contrast, non-native species exhibited the opposite pattern increasing in relative abundance (4%, 11% 19%) and total number of taxa (13, 15, 16) from the upper river to lower river reaches. The 1-km sample reaches in upper river contained 16 - 19 native fish species, but samples from lower river contained only 3 - 10 native fish species.

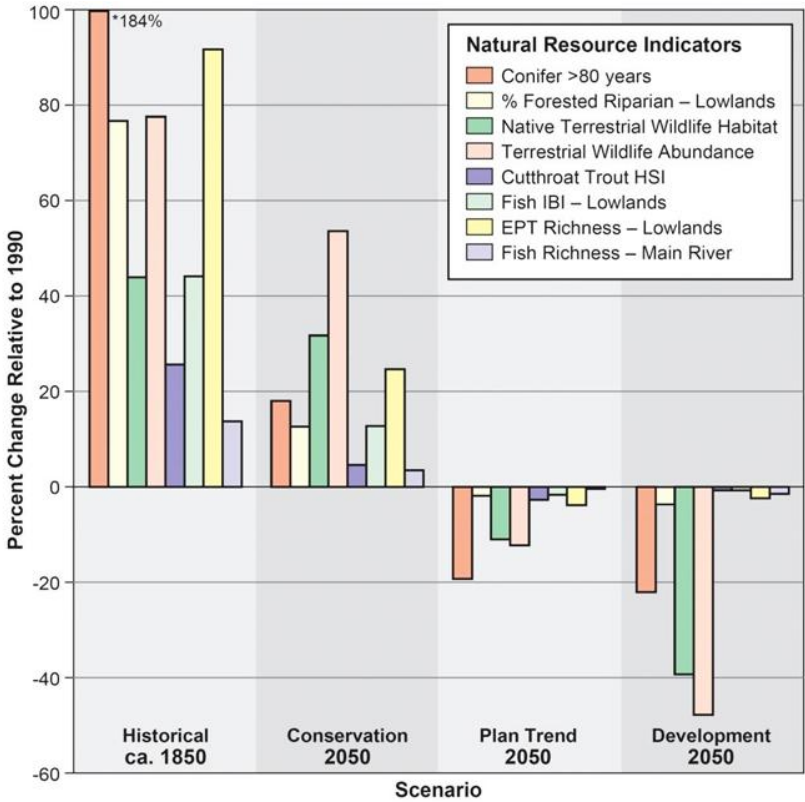

Figure 1. Percentage change in natural resources indicators in the Willamette River basin. Zero change represents resource conditions circa 1990 (Baker et al. 2004).

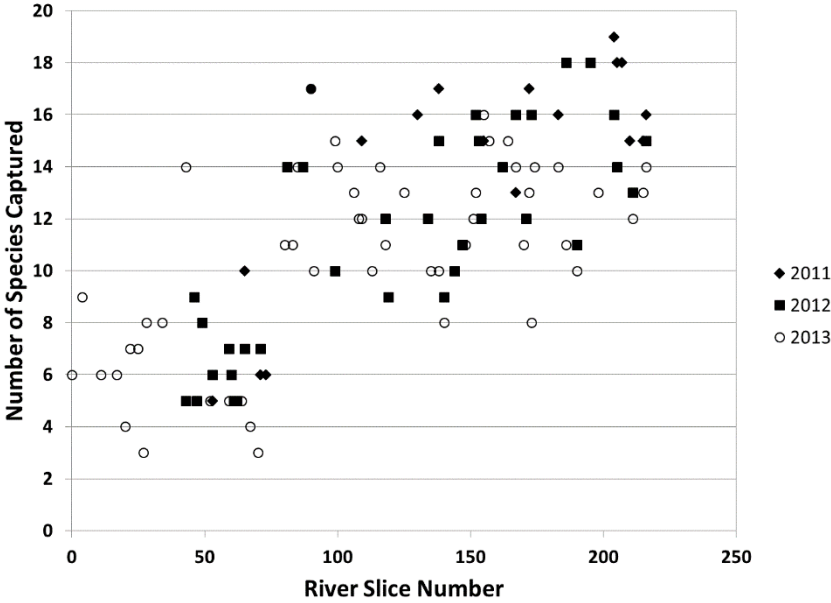

Figure 2. Number of fish species captured in standardized sampling of 1-km reaches of the mainstem Willamette River in summers of 2011-2013. The zero slice is located just upstream of the mouth of the Willamette and slice 227 is located upstream at the McKenzie River confluence.

We developed a Willamette River Fish Database (<http://gis.nacse.org/wrfish/>) to make spatially explicit data on fish communities in the mainstem Willamette River publicly available. Watershed councils, land trusts, NGOs, and state and federal agencies have full access to the data for designing projects to conserve or restore the aquatic ecosystems and floodplains of the Willamette River. The information also contributes to the collective development of a guiding vision of a future Willamette River and its floodplain for all partners.

Conclusions & Recommendations

The Willamette River has recovered greatly from past water pollution and river channel modifications, but it faces many threats in the future. Population growth in the region is expected to continue with a doubling in approximately 40-50 years. Land development continues to see increasing demands for urban and residential lands while agricultural and forest industries are fighting to protect their land base. Much of the new development pressures are in the valley along the mainstem Willamette River and its floodplain. Streams and river already approach the lethal limits of native cold water fish species, especially in the lower river near the major urban centers. Many miles of streams in the basin are listed by environmental agencies as water quality impaired because of water temperature. The climate in the basin is projected to warm by 1.0 to 3.4°C by the middle of the century. Water management authorizes are facing increasing demands to store water in reservoirs and withdraw more water during low flow seasons when the needs of the aquatic ecosystem also are most acute. As mentioned earlier, flood control reservoirs already have reduced sediment transport to the mainstem by 60% and peak flows in the river are reduced roughly 30 to 70%. The momentum of current trends and uncertainty of future changes make it critical for our region to anticipate the future Willamette River.

Partners in the Willamette River basin are creating a regional network of communities and restoration practitioners to 1) restore a geomorphically dynamic river, 2) facilitate ecological recovery, 3) meet social expectations, and 4) anticipate the future of the river and its human communities. One of the greatest challenges is to create a scientifically sound vision of the new river, a river that is changing because of its altered flow regimes and sediment supply, a river that is changing because of social changes in the towns and communities along its banks. We have attempted to create a foundation for at least understanding the geomorphic and plant successional processes of the Willamette River and how they are changing (Wallick et al 2013), but we need similar guidance for aquatic communities, social infrastructure, public policies, and economic alternatives.

Regional leaders in agencies and NGOs have invested in assessing the geomorphology, floodplain vegetation, and aquatic communities and are attempting to create a plan for future monitoring, but political and economic challenges are substantial. We have created public information sources such as the Planning Atlas, SLICES Framework, and Fish Database to provide information to the citizens and restoration practitioners along the river. But one of the major challenges is to create a shared vision of the river and its options for the future, a vision that is ongoing as constantly changing as the people who are part of the management and communities of the river change. The Meyer Memorial Trust is working with partners in the river restoration to create a Report Card for the

Willamette, which will provide grades on key features of the river that matter to its citizens.

The process of restoring the Willamette River basin is much like its river—dynamic and changing—reflecting the structure and processes not just of the river but also the communities along the river network. River management that ignores the fundamental processes of rivers and their ecosystems ultimately will destroy invaluable resource legacies and create costly problems for the future. But equally, river management that ignores the livability of its environment and economic health of its communities will lose public support. The central focus of river restoration inescapably must be the river in our communities, and sustainable river restoration will provide the design of a more ecologically sound and livable future.

References

- Gregory S.V. 2008. Historical channel modification and floodplain forest decline—Implications for conservation and restoration of a large floodplain river—Willamette River, Oregon. In Habersack, Helmut, Piegay, Hervey, and Rinaldi, Massimo, eds., *Gravel-bed rivers VI—From process understanding to river restoration*, pp. 763–777. Elsevier B.V.
- Hulse W.D, Gregory S.V & Baker J.P. 2002. *Willamette River basin planning atlas: trajectories of environmental and ecological change*. Oregon State University Press, Corvallis, Oregon.
- Hulse D.H & Gregory S.V. 2004. Integrating resilience into floodplain restoration. *Urban Ecosystems* 7: 295–314.
- Wallick J.R, Jones K.L, O'Connor J.E, Keith M.K, Hulse D & Gregory S.V. 2013. *Geomorphic and vegetation processes of the Willamette River floodplain, Oregon—Current understanding and unanswered questions*: U.S. Geological Survey Open-File Report 2013-1246. 70 p. <http://pubs.usgs.gov/of/2013/1246/pdf/ofr2013-1246.pdf>.

Hydromorphology-vegetation interactions along river corridors: a conceptual framework

Gurnell A et al.

A.M. GURNELL, M.T. O'HARE², D. CORENBLIT³, D. GARCÍA DE JALÓN⁴,
M. GONZÁLEZ DEL TÁNAGO⁴, R.C. GRABOWSKI⁵ & M. SZEWCZYK⁶

¹ School of Geography, Queen Mary University of London, Mile End Road, London, E1 4NS, UK.

² Centre for Ecology and Hydrology, Bush Estate, Penicuik, Midlothian, EH26 0QB, UK.

³ Geolab – UMR 6042, Université Blaise Pascal, Clermont-Ferrand 2, France.

⁴ E.T.S. Ingeniería de Montes, Forestal y del Medio Natural. Universidad Politécnica de Madrid, 28040, Madrid, Spain.

⁵ School of Energy, Environment and Agrifood, Cranfield University, Cranfield, Bedfordshire, MK43 0AL, UK.

⁶ Environmental Information Centre UNEP/GRID-Warsaw, Poland, and Faculty of Civil and Environmental Engineering, Warsaw University of Life Sciences (SGGW), Warsaw, Poland.

Introduction

In naturally-functioning river corridors, vegetation combines with hydromorphological (hydrological and fluvial) processes to influence channel and floodplain morphological complexity and dynamics (Corenblit et al., 2009; Gurnell, 2014). It is important to understand these natural interactions among vegetation and hydromorphological processes and how they may contribute to the resistance, change and recovery of river systems from human interventions. By working with these interactions as far as is possible, river management measures have the greatest likelihood of being both sustainable and cost-effective.

We propose a conceptual framework which recognises that plants both respond to and influence hydromorphological processes with certain plant species operating as physical ecosystem engineers (*sensu* Jones et al., 2010). These engineer plant species have traits that allow them:

- to tolerate, avoid and interact with different sets of hydromorphological processes depending upon their location in one of five river corridor zones,
- to drive landform or habitat development that increases their chances of survival while facilitating colonisation by other species

to play a fundamental role at the leading edge of vegetation–hydromorphology interactions within zones 1 (permanently inundated) and 2 (subject to frequent inundation and erosion and deposition of sediment). This 'critical zone' displays pioneer landforms that drive the advance of vegetated patches and the creation of a naturally-functioning river margins.

Five Dynamic Zones of Plant–Hydromorphology Interactions

The hydromorphological processes with which plants interact depend on their location within the river corridor. Five spatially and temporally dynamic zones can be identified (Figure 1). Zone 1 is perennially inundated and so may be absent in dry climate settings or in headwater streams where stream flows are ephemeral or intermittent. Zone 2 is frequently inundated and flow velocities are sufficient to erode, transport and deposit

sediment. Zones 3 and 4 are also subject to inundation but the period of inundation is less and flow velocities are lower than in zone 2, resulting in sediment deposition dominating in zone 3 and negligible sediment dynamics in zone 4. Zone 5 is rarely flooded and so soil moisture and groundwater hydrology dominate. The five zones display different surface water, soil water and groundwater dynamics, and fluvial disturbance intensity. Their hydromorphological character and extent vary with climate, river confinement and river planform type. Engineer plant species within each of the five zones display different sets of traits that allow interaction with local hydromorphological processes. Furthermore, different species undertaking a similar engineering role within each zone in different biogeographical settings.

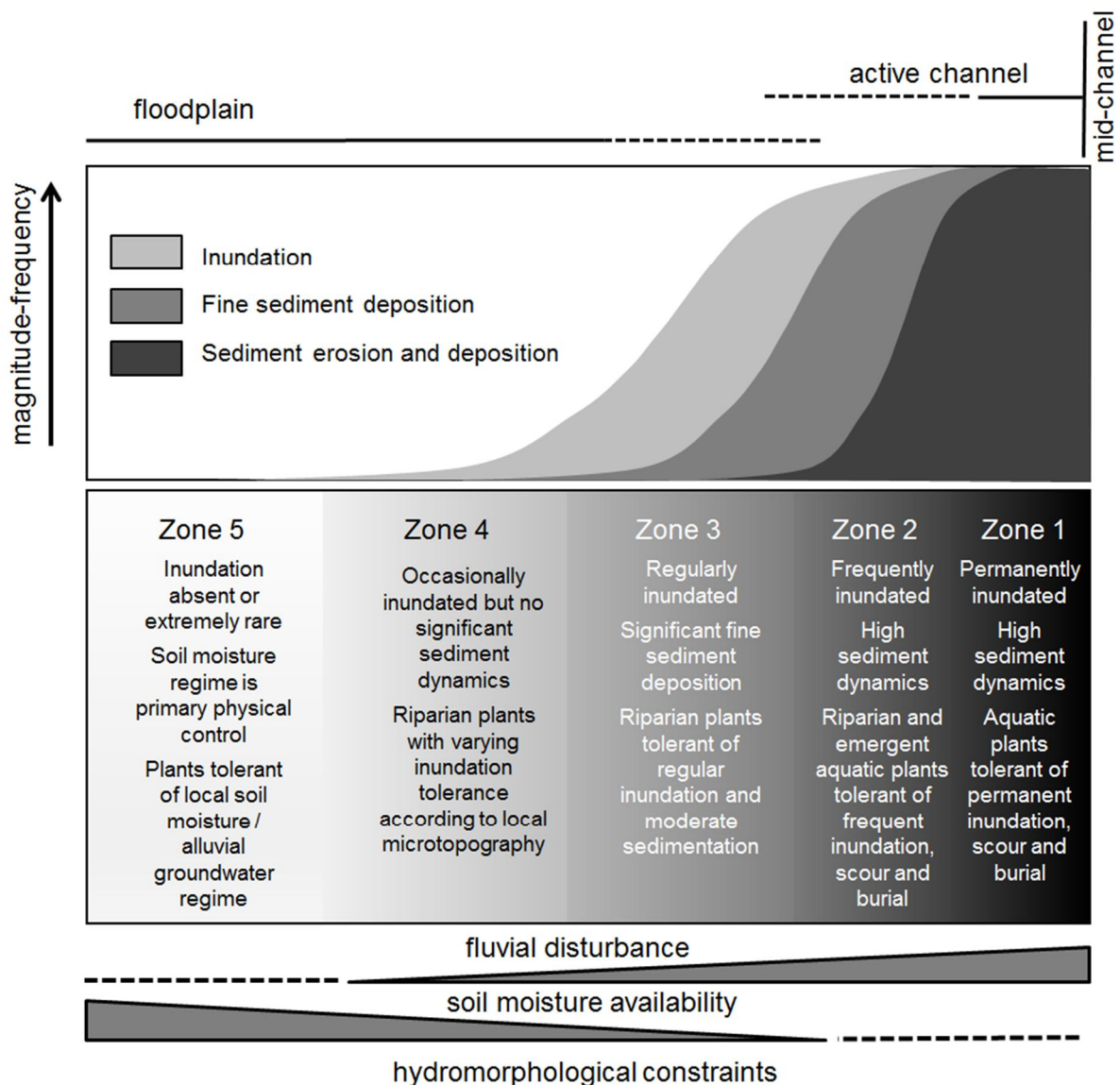

Figure 1. Hydromorphological characteristics of the five zones of a river corridor in relation to the magnitude-frequency of inundation, fine sediment deposition, or sediment erosion and deposition.

Landform Development from Vegetation-Hydromorphology Interactions

The development of characteristic assemblages of vegetation-related landforms within the zones of the river corridor can result from processes of self-organisation under the local hydrogeomorphological regime. In zone 5 and potentially also in zones 4 and 3, interactions occur between plants and the soil hydrological regime. In drylands, vegetation cover shades the ground surface, reducing evaporation, while root systems encourage infiltration, enhancing moisture availability locally and allowing vegetation to persist once present whereas areas of bare soil are too hostile for plant colonisation (e.g. Rietkerk et al., 2000). In wetland environments, plant productivity is often associated with groundwater depth, so that highly productive plants tend to be present on locally elevated, relatively drier, sites (e.g. Wetzel et al., 2005). In both examples, the plants harvest water or nutrient resources from their surroundings, and the vegetation cover becomes increasingly patchy as these resources become limited, resulting in shrub patches surrounded by bare areas in drylands and vegetated hummocks of organic material in wetlands. At the same time accumulation of organic material, particularly in wetland hummocks, can increase patch size and elevation. In zones 1 to 4 interactions between plants and hydromorphological processes of inundation, sediment erosion and deposition accentuate self-organisation (Francis et al., 2009). Local vegetated patches such as shrubs in dry areas, vegetated hummocks in wetlands, sprouting wood accumulations on river bars, and stands of aquatic plants on river beds slow flow velocities and trap water-transported sediments to aggrade the land surface. Flow constrictions between these aggrading, elevated patches increase flow velocities so that less sediment is deposited or the surface may be eroded between vegetated patches.

Critical Zone of Plant-Hydromorphology Interactions

In zones 1 and 2, hydromorphology–plant interactions are particularly strong. Bare areas colonised by plants often aggrade and enlarge by trapping fluvially-transported sediments and reinforcing the trapped sediments with their roots. These pioneer vegetated landforms may continue to grow and coalesce to form islands or they may attach to the floodplain (Gurnell et al., 2001). These landforms concentrate water flows so that intervening bare areas are maintained and landform coalescence may be retarded. In this way, a patchy leading edge of riparian or aquatic vegetation develops somewhere within zones 1 and 2 between the physical process-dominated river channel and the vegetation-dominated floodplain. Between large floods, engineer plant species drive the development, aggradation, expansion and coalescence of pioneer and larger vegetated landforms and advance the leading edge of the vegetated area. During large floods, erosion of vegetated areas and avulsions across vegetated areas cause the leading edge to recede.

Conclusions

The concepts presented here provide a way of viewing river corridors subject to different climatic, hydrological and fluvial processes within a single framework. Even in heavily degraded systems, incipient pioneer landforms associated with engineer plant species are often identifiable, providing an indication of their potential behaviour within zones 1 and 2. They may also be identifiable in isolated patches of the floodplain within zones 3 to 5, giving an indication of potential floodplain vegetation-hydromorphology behaviour. Coupling this evidence with historical information on past river and floodplain character and dynamics, allows an understanding to be developed of how these vegetation-driven

features might be incorporated into river and floodplain management and restoration activities.

Acknowledgements

The work leading to this paper has received funding from the European Union's FP7 programme under Grant Agreement No. 282656 (REFORM).

References

- Corenblit D, Steiger J, Gurnell AM, Naiman RJ. 2009. Plants intertwine fluvial landform dynamics with ecological succession and natural selection: a niche construction perspective for riparian systems. *Global Ecology and Biogeography* 18(4): 507-520.
- Francis RA, Corenblit D & Edwards PJ. 2009. Perspectives on biogeomorphology, ecosystem engineering and self-organisation in island-braided fluvial ecosystems. *Aquatic Sciences* 71: 290-304.
- Gurnell AM. 2014. Plants as river system engineers. *Earth Surface Processes and Landforms* 39: 4-25.
- Gurnell AM, Petts GE, Hannah DM, Smith BPG, Edwards PJ, Kollmann J, Ward, JV & Tockner, K. 2001. Riparian vegetation and island formation along the gravel-bed Fiume Tagliamento, Italy. *Earth Surface Processes and Landforms* 26(1): 31-62.
- Jones CG, Gutiérrez JL, Byers JE, Crooks JA, Lambrinos JG & Talley TS. 2010. A framework for understanding physical ecosystem engineering by organisms. *Oikos* 119: 1862-1869.
- Rietkerk M, Ketner P, Burger J, Hoorens B, Olf H. 2000. Multiscale soil and vegetation patchiness along a gradient of herbivore impact in a semi-arid grazing system in West Africa. *Plant Ecology* 148: 207-224.
- Wetzel PR, van der Valk AG, Newman S, Gawlik DE, Troxler Gann T, Coronado-Molina CA, et al. 2005. Maintaining tree islands in the Florida Everglades: nutrient redistribution is the key. *Frontiers in Ecology and Environment* 3(7): 370-376.

Contrasting the roles of section length and instream habitat enhancement for river restoration success: A field study on 20 European restoration projects

Hering D

DANIEL HERING

*University of Duisburg-Essen, Department of Aquatic Ecology,
45239 Essen, Germany.*

Restoration of river hydromorphology often has limited detected effects on river biota. One frequently discussed reason is that the restored river length is insufficient to allow populations to develop and give the room for geomorphologic processes to occur.

In a pan-European study, we investigated ten pairs of restored river sections of which one was a large project involving a long, intensively restored river section and one was representing a smaller restoration effort. The restoration effect was quantified by comparing each restored river section to an upstream non-restored section. We sampled the following response variables: habitat composition in the river and its floodplain (e.g. gravel bars and instream habitats), three aquatic organism groups (aquatic macrophytes, benthic invertebrates and fish), two floodplain-inhabiting organism groups (floodplain vegetation, ground beetles), as well as food web composition and land-water interactions reflected by stable isotopes ($\delta^{13}\text{C}$ and $\delta^{15}\text{N}$ signatures of resources and organisms).

For each response variable, we compared the difference in dissimilarity (Bray-Curtis index) of the restored and nearby non-restored section between the larger and the smaller restoration projects. In a second step, we re-grouped the pairs and compared restored sections with large changes in substrate composition to those with small changes.

When comparing all restored to all non-restored sections, ground beetles were most strongly responding to restoration, followed by fish, floodplain vegetation, benthic invertebrates and aquatic macrophytes. Aquatic habitats and stable isotope signatures responded less strongly.

When grouping the restored sections by project size, there was no significant difference in the response to restoration between the projects targeting long and short river sections with regard to any of the measured response variables except nitrogen isotopic composition. In contrast, grouping the restored sections by substrate composition, the responses of fish, benthic invertebrates, aquatic macrophytes, floodplain vegetation and nitrogen isotopic composition were greater in sections with larger changes in substrate composition as compared to those with smaller changes.

The effects of hydromorphological restoration measures on aquatic and floodplain biota strongly depend on the creation of habitat for aquatic organisms, which were limited or not present prior to restoration. These positive effects on habitats are not necessarily related to the restored river length.

Introduction

A variety of reasons for limited biotic effects of hydromorphological restoration measures has been suggested, including stressors acting at larger scales, such as catchment land use, water quality, and hydrological alterations; insufficient restoration of hydromorphological processes; minor changes in relevant microhabitats; lack of recolonisation potential and blocked recolonization pathways.

Many of these parameters, which potentially confound the effects of hydromorphological improvement, depend on the restored river length. Hydromorphological processes, including the formation of meanders and braided patterns and of riffle-pool sequences, are scale dependent. Similarly, water quality parameters may depend on the size of the restoration: the effect of riparian forests on water temperature is dependent on the length of a shaded river section; self-purification depends on the contact area of stream water and substrate which is enhanced by near-natural morphology. On average, short restored sections are more strongly impacted by stressors acting at the catchment scale (e.g. fine sediment entry). Finally, viable populations of aquatic organisms require a minimum area of suitable habitats or essential habitats, e.g. spawning and rearing areas for fish. A strong correlation between the size of the restoration project and the biological effects can therefore be assumed.

Using a post-treatment design, we analysed the effects of hydromorphological river restoration measures on different response variables depending on the length of the restored river section. We investigated ten pairs of one long and one short restored river section to address the role of section-length for river restoration effects. The restoration effect was quantified by comparing each restored river section (treatment) to a nearby non-restored section (control). We addressed a large number of response variables, including habitat composition in the river and its floodplain, three aquatic organism groups, two floodplain-inhabiting organism groups, as well as food web composition and land-water interactions reflected by stable isotopes.

We expected that section length has a minor effect on response variables which strongly react to restoration (such as floodplain habitats), while it will boost the effect of restoration on variables generally responding poorly to restoration. Further, we expected the increase in substrate (habitat) diversity caused by restoration to directly affect the biota, i.e. restored sections differing strongly in habitat composition from nearby degraded sections will also differ most strongly in assemblage composition.

Methods

We used an extensive-post treatment design to sample multiple paired treatments (restored) and controls (unrestored). In ten regions across Europe we sampled four river sections: one extensively restored river section (treatment, R1), one short restored section (treatment, R2) and two non-restored, degraded sections each one upstream of the restored sections (controls, respectively D1 and D2). Each of the 40 sections was sampled for a large number of response variables: hydromorphological variables, three aquatic organism groups (fish, benthic invertebrates and aquatic macrophytes), two floodplain-inhabiting organism groups (ground beetles and floodplain vegetation) and stable isotopes as indicators of land-water interactions ($\delta^{13}\text{C}$) and food-web interactions ($\delta^{15}\text{N}$).

For each response variable, we calculated the similarity (Bray-Curtis index) of the restored (R) and the nearby non-restored (D) section. We then calculated the difference between the Bray-Curtis indices of the long restored sections (R1) and the short restored sections (R2).

In a second step, we re-grouped the sections based on the analysis of the hydromorphological data survey and compared sites with larger changes in substrate and habitat composition (S1) to those with smaller changes (S2).

While restored sections in a given region were selected to differ in just restoration intensity and were comparable in terms of river size, catchment land use and altitude, there were considerable differences between regions (supplementary material 1 and 2). To account for these regional differences we limited direct comparisons of restored sections to the corresponding pairs and their degraded control sections. For comparisons between regions, we used the pairwise difference of corresponding sections (R1 minus R2; S1 minus S2). With this design we avoided confounding effects of river size, altitude, stressors and restoration measures, all of which differ considerably between regions and influence restoration success.

Results

Restoration effects did not differ between the long (R1) and short (R2) restored sections (Fig. 1). Positive values of the Bray-Curtis dissimilarity of a long restored section (R1) minus a short restored section (R2) indicates a larger restoration effect of R1 sections. Median difference of all restoration section pairs was indeed positive for all response variables, except for ground beetles and fish. However, in contrast to our expectations, restoration effects of long and short restored sections was not significantly different ($p > 0.17$), except for the food web interactions ($\delta^{15}N$) (Wilcoxon Matched Pairs test, $n=10$, $p < 0.05$).

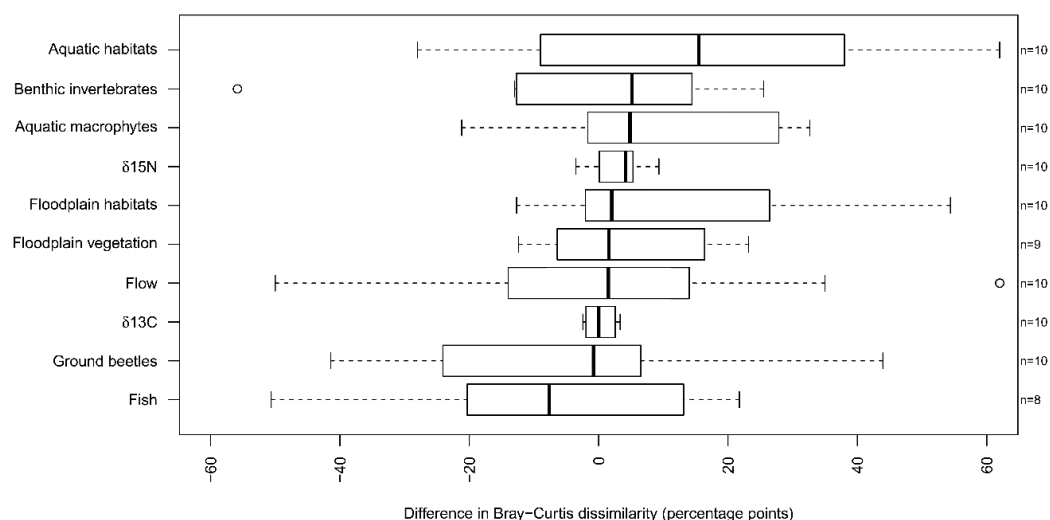

Figure 1: Difference between the restoration effects (Bray-Curtis dissimilarity) of the long (R1) and short restored section (R2) (i.e. R1 minus R2 values) for morphological and biological response variables. Median values, quartiles, and non-outlier range of all pairs are shown.

The alternative grouping of sections into those with larger and smaller changes in substrate composition was based on the Bray-Curtis dissimilarities of bottom substrates. These ranged from 3 to 76 (median = 29.7).

Restoration effect was generally larger in those restored sections where changes in aquatic substrate conditions were more pronounced compared to the corresponding restored sections with smaller changes. Median difference of the restoration section pairs was positive for all response variables (Fig. 2) indicating a larger restoration effect of S1 sections compared to the corresponding S2 sections. Moreover, restoration effects of S1 sections were significantly larger for most response variables: benthic invertebrates, aquatic macrophytes and all recorded morphological response variables (flow diversity, floodplain habitats) (Wilcoxon Matched Pairs test, $n = 9-10$, $p < 0.05$). Though differences between S1 and S2 were not significant for fish (probably due to the small sample size), the differences were positive, larger than between R1 and R2, and nearly significant ($p = 0.08$).

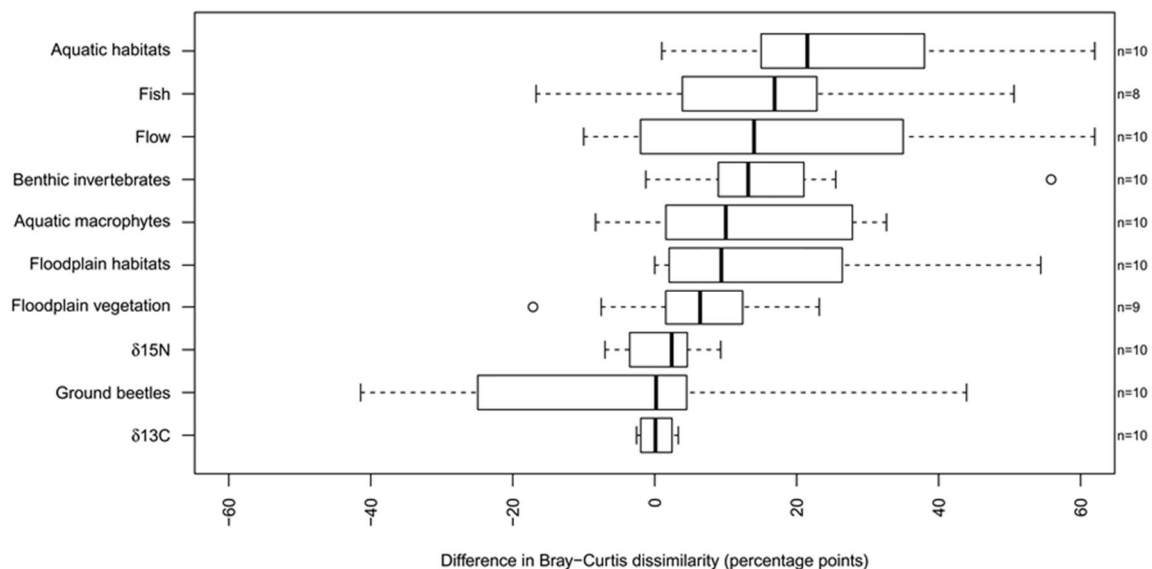

Figure 2. Difference between the restoration effects (Bray-Curtis dissimilarity) of the restored sections with higher changes in substrate conditions (S1) and the corresponding restored sections with smaller changes (S2) (i.e. S1 minus S2 values) for morphological and biological response variables. Median values, quartiles, and non-outlier range of all pairs are shown.

Conclusions

For effects on aquatic or floodplain biota the length of the restored section was not directly relevant, maybe as even the large measures addressed in our study are still too small for an additional positive effect based on project size. Habitat composition has an impact on both floodplain and aquatic biota. In case of the floodplain assemblages, in particular ground beetles, already minor restoration effort results in significant effects, obviously as small habitat patches are already sufficient. In case of aquatic biota, larger substrate changes are required, as revealed by the differences in Bray-Curtis dissimilarities between projects leading to smaller and larger substrate changes. The

results might have been impacted, however, by differences in dispersal capacity between organism groups and in the vicinity to source populations between restored sites. In conclusion, the effects of hydromorphological restoration measures on aquatic and floodplain biota strongly depend on the generation of habitats for aquatic and riparian organisms, which were not present, or not sufficiently so, prior to restoration. These positive effects on habitats are not necessarily related to the length of the restored section.

The Economic Value of Restoration based on the Ecosystem Services Approach

Koundouri P & Souliotis I

Phoebe Koundouri^{1,2,3, †} & Ioannis Souliotis^{1,3}

¹ Athens University of Economics and Business, GREECE.

² London School of Economics, UK.

³ International Centre for Researcher on the Environment and the Economy (ICRE8), GREECE.

[†] Correspondent author: pkoundouri@aueb.gr, phoebe.koundouri@icre8.eu

The term "scarce" is often used to describe the limited quantity of water resources. The optimal allocation of scarce resources is the core of environmental economics. This requires deciding upon how a resource will be used in time (among current and future generations) and space. In order to do that we should consider the potential trade-offs between quantity or quality of resources, levels of characteristics, groups of individuals in a society, generations and so on.

As far as Neoclassic economic theory is concerned, an allocation of resource, described as a change in the circumstances, can be socially desirable if some individuals are better off, while no one is worse off, or if all the individuals are better off. Such a conclusion is based on one's welfare in relation to different statuses. Optimal results can be obtained as long as property rights on the water are well-defined. This case holds, when the resources are *privately owned* and the owner is *endowed* with all the benefits and costs from the use of these resources. However, due to the non-market nature, uncertainty related to climatological conditions (recharge rate of the basin etc.) and asymmetric information among users of the resource (policy makers, extractors, polluters etc.) of water resources these conditions are not fulfilled. In other words, individuals have the incentive not to reveal their preferences in order to avoid bearing costs related to the provision of an environmental (public) good.

The arsenal of economic techniques provides the solution to such problems. More specifically, economists attempt to model human behavior taking into account the functioning of ecosystems in order to achieve a status that ensures sustainability (environmental, societal, economic). To elaborate more, the interactions between water quality and quantity, water pollution, water demand for different uses and total cost (financial, environmental, resource) are usually investigated. Any changes in these would result in changes in the welfare that should be considered in policy making in order to achieve sustainable management of water resources.

Table 1. Total Economic cost of water *Adopted from* Koundouri, Remoundou, & Kountouris, 2009.

Financial Cost	Capital cost, operation cost, maintenance cost and administrative cost.
Environmental Cost	The environmental cost represent the costs of damage that water users impose on the environment and ecosystems and those who use the environment (e.g. a reduction in the ecological quality of aquatic ecosystems or the salinization and degradation of productive soils).
Resources Cost	Resource cost represents the costs of foregone opportunities that other uses suffer due to the depletion of the resource beyond its natural rate of recharge or recovery (e.g. linked to the over-abstraction of groundwater).

Apart from economic modeling, economic valuation aims at eliciting people’s preferences in relation to a good. This circumvents the hurdle of hidden preferences. Broadly speaking, economic valuation consists of three approaches, namely Revealed Preference methods (RP), Stated Preference Methods (SP) and Benefit Transfer. These methods are used to gauge the Total Economic Value of an ecosystem as this decomposes into use (direct, indirect), passive values (altruistic, existence, bequest) and option value. The total economic value of an ecosystem (TEV) can be divided into use and non-use values. Use value is related to the actual use of the good, or the possibility for actual use in the future, and is a quite straightforward concept. Actual use is divided into direct (e.g. potable water) and indirect values (e.g. generation of incomes). Non-use values, or passive-use values, can be classified into existence value, bequest value and option value.

The information used by each of these varies. RP use actual data and surrogate markets to trace the “footprint” of the value of the resource. On the other hand, SP use hypothetical markets and individuals’ responses. Different techniques are used when changes need be valued ex ante or ex post. Specifically, only SP are operational under both contexts and also elicit use and passive values. For this reason SP seem to be more appropriate in the context of environmental resources, since environment encompasses passive values.

Under either economic modeling or valuation, the necessity of interdisciplinary approaches arises, given the complex nature of the environment. Natural processes and their benefits to humans are both incorporated economic analysis. The Total Economic Value of Ecosystems and Biodiversity initiative has created a new paradigm for economic valuation. Ecosystem services (provisioning, regulating, cultural and habitat) can be seen as the output of the ecological production function. Consequently, any alterations on the inputs or levels of inputs in this production process will affect the final good. This could be the consequence of climate change or human intervention. Therefore, it is crucial to construct realistic scenarios about future changes when resource management is

designed. The aim of such a task is to take into account the risks and uncertainty that are embedded in projections of the future.

Lastly, another crucial aspect that should not be neglected, when designing policies related to natural resources is the importance of institution reforms. The institutional reforms should move away from water policies that favor fragmentation and lack of coordination among the involved actors in the decision making process. These reforms should also embrace and promote the growing concerns on environmental aspects and "sustainable" water management suggesting integrated approaches. (Koundouri et al, 2013). This is due to the fact that, the institutional reforms associated with changes in the distribution of power and benefits can create political opposition and the larger the number of interest groups the more complicated the implementation of the above measures/reforms, as they have a role to play in both the design and implementation stages of a reform.

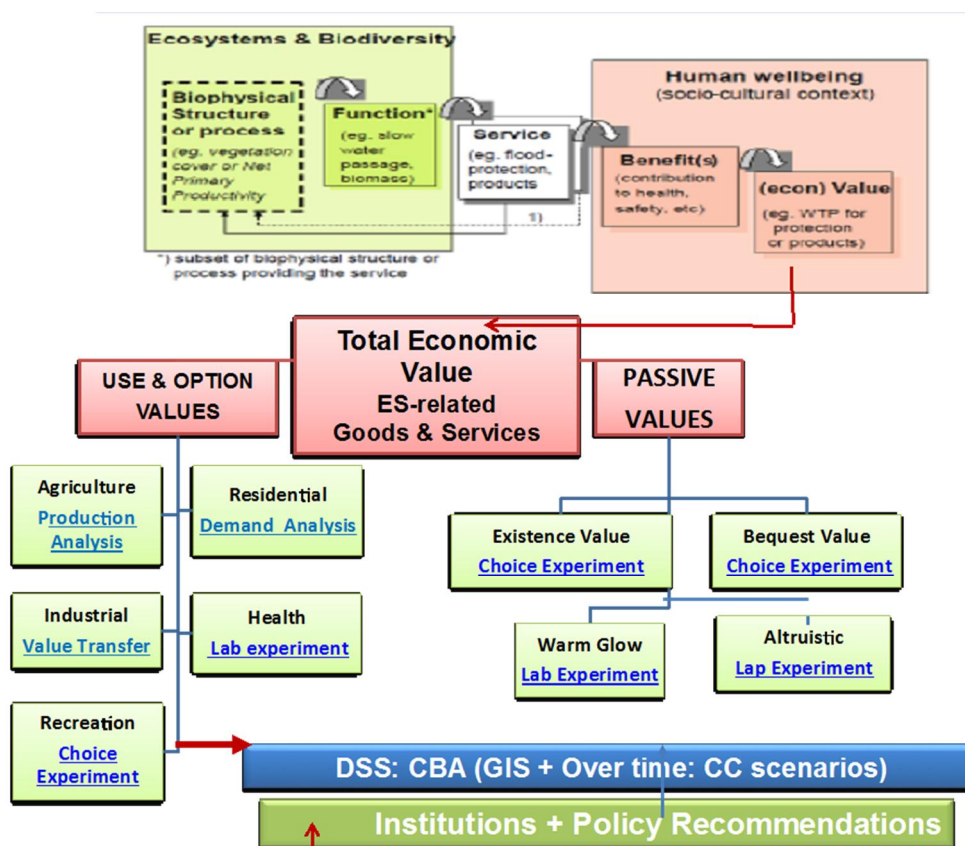

Figure 1. Integration of Ecosystem Services Approach in Economic Analysis.

It is obvious that policy designing requires the combination of many different fields of science in order to analyze the complexity of the environment and human behavior. Therefore, biologists, chemists, ecologists, sociologists, engineers and economists must work together in order to design policies that are socially, economically and environmentally optimal. The literature shows a trend towards this state, however many fields of environmental management are still need to follow a holistic approach. As an example, it could be mentioned the fact that although there is a vast number of restoration projects worldwide, only some of them achieve sufficient integration of natural and social sciences.

References

- Koundouri P & Papandreou N.A. 2013. *Water Resources Management Sustaining Socio-economic Welfare: The Implementation of the European Water Framework Directive in Asopos River Basin in Greece* (Vol. 7). Springer Science & Business Media.
- Koundouri P, Remoundou K & Kountouris Y. 2009. A Note on the Implementation of the Economics of the EU Water Framework Directive under Data Limitations: A rapid appraisal approach.

Improving river restoration policy: a few discussion points following 10 to 20 years of actions

Piegay H et al

HERVE PIEGAY, ADRIEN ALBER, BERTRAND MORANDI, JEREMIE RIQUIER, MARIE SPITONI

*EVS, UMR 5600 CNRS, University of Lyon, 15 Parvis R. Descartes
Lyon, 69007, France*

After almost 10 to 20 years of restoration actions on rivers, a few feedbacks can be discussed for improving policy. Especially, very basic questions can be considered within the new lights of these feedbacks. Why and how should we restore rivers? Which rivers should we restore? Some examples are shown to illustrate how such questions are still challenging.

Introduction

Reaching a "good ecological status" of rivers is a challenging issue for the EU state members in charge of implementing the Water Framework Directive. In this domain, acting on hydromorphological drivers is one way which is known as restoring rivers. After almost 10 to 20 years of actions in this domain, a few feedbacks can be discussed for improving policy. Especially, very basic questions can be considered with the new lights of these feedbacks, Why? Where? How?

Why should we restore rivers?

Definition of river restoration evolved over the last two decades and a conceptual and social debate is still needed to reconsider objectives. The Water Framework Directive considered that the aim is reaching a good ecological status for rivers but some of the stakeholders or local elected people can question this aim which may not be a priority for them partly because it does not show explicitly the wider benefits associated to this objective. Moreover, the aims of such actions also evolve over the last decades, restoration being not a way to reach a state which is functionally and structurally the one we had prior to the human disruption as argued in the 1980s but a way to reach a state which can provide sustainably a set of (ecosystem) services. What are the services which are expected? Again debate on what it is expected is still opened. One of the main issues is to balance local or individual expectations with regional or wider collective aims, as well as short term and long term needs which are valuable for different stakeholders.

If river restoration, rehabilitation and renaturation concepts are widespread, one question still remains: How concepts are used and defined by scientists and river practitioners? Ambiguity of definitions to original, past or pristine references exists between scientists and practitioners as well as amongst scientists ; semantic fields of scientific literature are not shared worldwide but are surprisingly regionalized. Moreover, human is generally considered as disturber in a very conventional human-nature opposition. Discussion about the definition of criteria used to design such policy (e.g. stability and dynamic, diversity, connectivity, resilience, integrity) and

about the reference to consider to assess efficiency of actions (Dufour et Piégay 2009; Dufour et al. 2014) are still needed.

The concept of 'reference' is still debated within the scientific community and amongst practitioners (Morandi et al. 2014). References can be historically based, geographically-based or process-based, and absolute or relative depending if a threshold is determined. Historical references were probably the dominant approaches when implementing early restoration projects, whose aims were to return to a "pre-disturbance" state functionally and structurally, with past conditions often being idealized and the environment without humans being valued. In the context of the implementation of the EU Water Framework Directive, the geographical reference has been promoted, with the best conditions being the most natural system within a given geographical context. In restoration monitoring, a relative reference is often used which is also a bit contradictory with the WFD requirements. The BACI protocol (Before/After/Control/Impact) permits testing whether restoration actions have an effect independently of other factors acting at a wider scale. It is relative in the sense that it is difficult to judge whether observed changes are significant, so that thresholds must be determined as a basis for assessing success.

Which rivers should we restore?

The second question which is also in discussion is "where?", where restoring rivers? There is a clear need to improve network understanding to establish a top-down strategy to define priorities, improve planning design and target actions and exit from opportunistic strategy based on local wish without considering regional hot-spot, urgency or level of disruption. At a regional scale, geomorphic assessments can identify priorities and inform an adaptive strategy when previous measures were not sufficient or adapted to solve the problems (Figure 1). There is therefore a clear need to characterize hydromorphic status of river network, assess human pressures and improve models linking physics and ecological features to support a planning strategy and target actions. A regional river database can be used to inform restoration strategies, plan field campaigns, and prioritise the implementation of river management measures based on quantitative and objective indicators.

In the EU, river basin authorities increasingly seek to set aside erodible corridors, and thus need to identify reaches with potential for active channel shifting, which would be the best candidates for designing as erodible corridors. For the French Rhône district, we propose a model to predict lateral erosion potential from stream power and active channel width at the scale of the 40,000-km long river network. The approach is based on a GIS procedure (Alber and Piégay, 2011) to map unconfined alluvial plains within which channels are potentially mobile. The model is then applied at an entire network scale to provide a map of channel migration potential, useful for managers in charge of targeting reaches for shifting preservation and restoration.

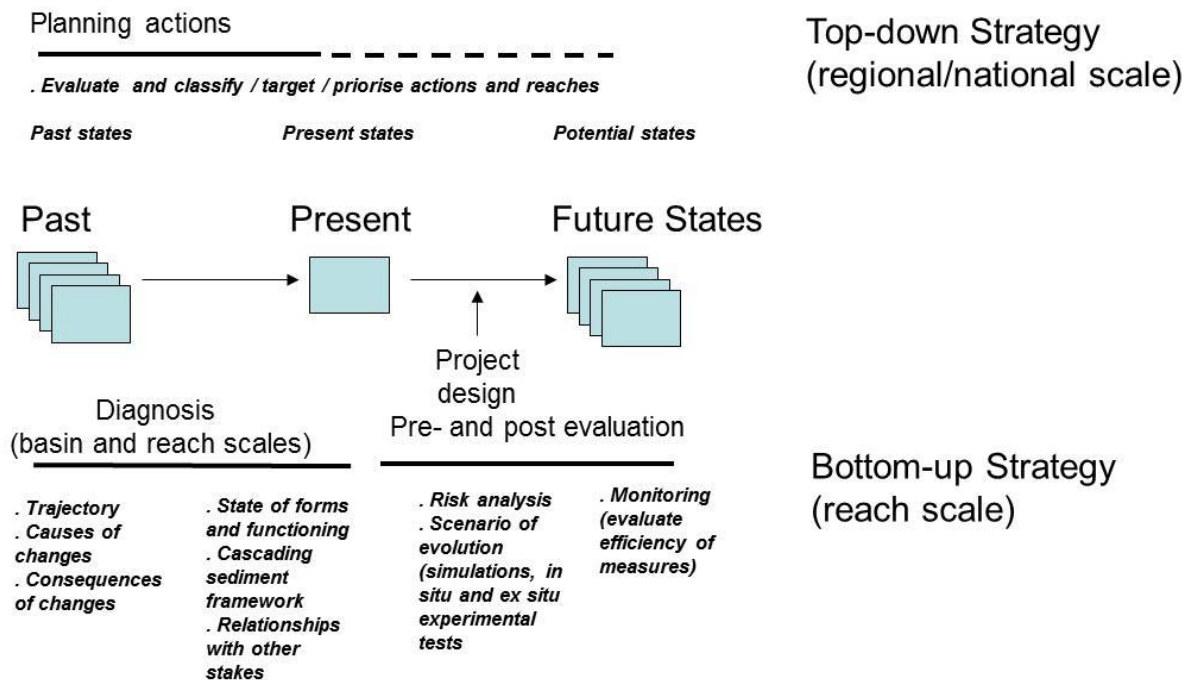

Figure 1. General framework of geomorphic studies applied to river restoration: diagnosis and project appraisal, top-down and bottom-up strategies (From Piégay et al., 2015, in press).

How should we restore?

“How restoring rivers” is another critical question. Should we primarily act on forms or on processes? The recent policy emphasis on sustainable river channel management and ‘Working with Natural Processes’ exemplifies a shift of stance. Nevertheless, statutory requirements to take regard for “physiographic features” or “hydromorphology” and the ecological integrity of river systems have focused attention on their natural form more than their processes. Legislation clearly emphasise on the static descriptive nature of ‘geomorphology’, which lags 30-40 years behind the shift away from this position in Geomorphology. We typically lack an understanding of basin-scale influences or even channel-level process interactions that actually determine the success of the intervention, notably on rivers sensitive to changes and rapid adjustments.

Assessing the sensitivity of rivers to change is a clear challenge to evaluate the sustainability and efficiency of potential restoration actions and has also consequences in term of diagnosis (Rollet et al., 2014). This is a challenging issue which should be considered at a network/regional scale for targeting restoration strategy being able to distinguish river types sensitive to changes and on which it could be accurate to act on forms (if not too sensitive) or processes (if sensitive).

“How” is also related to gaining experiences and knowledge for implementing these new measures. Monitoring efforts combined with modeling are critical for assessing restoration success and then designing successful measures. We report main results of 15 year sedimentation monitoring of a set of restored floodplain channels along the

Rhône River. We show that both (i) grain size patterns and (ii) overbank fine sedimentation rates can be predicted using simple hydrologic (e.g. upstream overflow frequency) or hydraulic (e.g. shear stress) indicators. These results are now used to guide future restoration actions in the Rhône and other similar hydrosystems (Riquier et al. 2015).

Conclusions

At this stage of the evolution of the restoration practices, there are strong needs to articulate the benefits of the geomorphic approach, to identify indicators and metrics to monitor and assess the efficiency of measures, to learn from experience in river interventions, to develop more collaborations among scientific communities to benefit from experiences in different contexts, and to use more of the (complementary) tools available. The development of models is a key challenge, as there are needs to simplify them, to adapt them to local context, and to retrospectively test their performance. For each river, a conceptual model should be developed and the hypothesized links tested. While scientists may base actions on a clear understanding of the river's past trajectory and the understanding of the current processes and interactions, they also use a set of tools to predict future changes. Risk analysis, predictive modeling at increasingly large spatial and temporal scales, and field/flume experiments are becoming essential to design sustainable improvement measures, balancing immediate and long-term goals.

Scientists can provide insights in the underlying causes of 'symptoms' of ecological or stability problems in rivers, evaluate pro and cons of different scenarios, and make recommendations. However, even if the geomorphological analyses and predictions are correct, that does not guarantee a successful project because of other factors, such as cost efficiency and social acceptance. Interdisciplinary teams and scenario elaboration (prospective approaches) can help improve the chances of success of future projects.

References

- Alber A & Piégay, H. 2011. Spatial aggregation procedure for characterizing physical structures of fluvial networks: applications to the Rhône basin. *Geomorphology* 125(3): 343-360.
- Dufour S & Piégay, H. 2009. The myth of the lost paradise to target river restoration : forget natural reference, focus on human benefits. *River Research and Applications* 25(5): 568-581.
- Dufour S., Rinaldi M., Piégay, H & Michalon, A. 2014. How do river dynamics and human influences affect the landscape patten of fluvial corridors? Lessons from the Magra River (Central – Northern River). *Landscape and Urban Planning* 134:107-118.
- Morandi B., Piégay H., Lamouroux N & Vaudor, L. 2014. How is success or failure in river restoration projects evaluated? Feedback from French restoration projects. *Journal of Environmental Management* 137(1):178-188.
- Piégay H., Kondolf G.M & Sear D. 2015. Chapter 22. Integrating geomorphological tools to address practical problems in river management and restoration. in M.G. Kondolf & Piégay H. (eds): *Tools in fluvial geomorphology*. J. Wiley and Sons, Chichester, U.K. 2nd Edition.
- Riquier J., Piégay H. & Michalkova M. 2015. Spatial and temporal variability of hydromorphological conditions in 18 restored floodplain channels along the French Rhône River: linking patterns to processes. *Freshwater Biology*.
- Rollet A.J., Piégay H., Bornett G., Dufour S., Lejot J. & Persat H. 2014. Assessment of consequences of sediment deficit on a gravel river bed downstream of dams in restoration perspectives: application of a multicriteria, hierarchical and spatially explicit diagnosis. *River Research and Applications* 30(8): 939-953.

Gaps and possible ways forward for river restoration

Pollard P

PETER POLLARD

Scottish Environment Protection Agency, UK.
Peter.Pollard@sepa.org.uk

What does good status hydro-morphology look like - some possible concepts and principles?

Across Europe, we have set ourselves the goals of protecting rivers at good status and restoring those that are worse than good back to good wherever feasible and proportionate. To achieve these goals, we need a clear understanding of what good means – including the hydro-morphological conditions required for good: As regulators, we need to know what matters for good so that we can judge whether development projects will compromise our goals. As river restorers, we need to know what success looks like.

Good status requires there to be only a “slight” change in the abundance and diversity of wildlife in river water bodies compared with what would be expected under near natural hydro-morphological conditions: Rivers at good status are places where water plants and animals are still thriving – in terms of their abundance and diversity. Whether they thrive will be some function of whether the right habitats are present; how much of those habitats are present (the space for thriving); the connectivity between habitats; and the quality of the habitats.

Experts from the different countries and the European Commission have been working together on a Common Implementation Strategy for river basin management. That work has had increasing emphasis on hydro-morphology over the last few years. However, it has not yet generated a common understanding on good hydro-morphology.

This presentation will consider principles for establishing what good hydro-morphology might look like at a river water body scale.

Why ecological assessments matter and why we haven't yet got them – a non-scientist perspective?

The objectives we are required to achieve are ecological. Restoration work can be expensive. We need ecological assessments to help show the investment is both needed and that it has been effective.

One of the big achievements of the last decade or so has been the step change in many countries' ability to assess the ecological impact of pollution, in particular nutrient enrichment, and to do so in comparable ways. We know this because of an EU-wide exercise to compare biological assessment systems, called inter-calibration.

It is far less clear that many countries have developed an equivalent level of competence in assessing the ecological impacts of hydro-morphological change. This presentation will argue that we need to re-think the problem; focus initially on systems that can pick up severe impacts rather more subtle impacts. To do this we need to start with an

understanding of the hydro-morphological change – and this means bringing together biological and hydro-morphological expertise.

Where can we achieve good status and some thoughts on the components of a national restoration delivery framework?

Rivers have been modified to help deliver a wide range of important societal benefits, including flood defence, drainage of productive farmland, drinking water supply and hydroelectricity generation. We cannot achieve good status everywhere without significant impacts on these important benefits.

Work in the Common Implementation Strategy shows there has been considerable progress in the development of national strategies for improving rivers affected by water abstraction and impoundment for uses such as hydroelectricity generation and water supply. This includes identifying relevant mitigation; setting constraints on what can be achieved - for example in terms of national limits on the reduction in hydroelectricity generation; and prioritising improvements in order to maximise environmental benefits within the constraints.

This presentation will argue that to achieve our goals for rivers, we also need to develop national strategies for the many rivers that are squeezed, and hemmed in, by surrounding urban and rural land uses. Such a strategy has to decide how it balances land use priorities with river restoration – how the land use settings of our rivers can, and will inevitably, shape what can be achieved.

Key considerations for measuring river restoration success: lessons from Western North America

Roni P

PHIL RONI

*Watershed Program, Northwest Fisheries Science Center, NOAA Fisheries
2725 Montlake Blvd. E.
Seattle, Washington, 98112, USA.
phil.roni@noaa.gov*

Abstract

Despite the fact that scientists have been calling for better evaluation of restoration for more than 75 years, adequate information on the success of river restoration techniques is still needed. This is due to both technological and social challenges to monitoring restoration responses including: the scale of restoration and its response, the ability to control timing of restoration and management actions, and adequate monitoring and sampling designs. Several monitoring programs to evaluate restoration in the United States, costing tens of millions of dollars, highlight these challenges. Evaluation of reach-scale response to restoration has suffered from similar problems with numerous successes and failures in the United States and Europe. Here I outline the key steps to evaluate river restoration success and provide examples of effective approaches to evaluate actions programmatically. Surprisingly, many monitoring and evaluation programs still fail because they do not address key steps in the monitoring design process including: identifying goals, hypothesis, response scale, appropriate monitoring and sampling design, sample size, monitoring implementation, and analysis and reporting of results. Both reach and watershed scale evaluations of restoration require extensive coordination and identification of cost-effective metrics for measuring success. The larger the restoration and monitoring program, the more critical coordination and identification of key metrics becomes. Cost-effective approaches for collecting habitat data have been developed, but are still needed for biota and examining system productivity. A recently implemented program to evaluate restoration in the Columbia River basin provides an example of a successful programmatic approach to evaluating river restoration at multiple scales.

Introduction

River restoration to improve fish habitat has a long history dating back at least 100 years in Europe and the United States (US) (Thompson and Stull 2002). In the last few decades it has become a growth industry not only in North America and Europe, but globally (Cunningham 2002). Estimates from more than 10 years ago indicate that 1 billion dollars are year are spent on river restoration in the US alone (Bernhardt et al. 2005). Nowhere is this more evident than western North America, where approximately 500 million US dollars are spent every year in efforts to restore watershed for endangered salmon and other anadromous fishes.

Despite this large investment in restoration, monitoring to evaluate success of different restoration measures has not kept pace with the restoration. More than 75 years ago it was noted that better evaluation of river restoration was desperately needed (Tarzwell 1937). While there have been some improvements in monitoring design, methods, and

techniques, restoration projects still are not adequately evaluated and most evaluations occur at the project or reach scale rather than at the catchment scale. Moreover, many monitoring efforts, like restoration, are opportunistic and few large “programmatically” monitoring programs have been successfully implemented. This is due to a combination of technical and non-technical challenges in designing and implementing adequate monitoring and evaluation of success. In this paper, I discuss key challenges, steps needed to adequately evaluate river restoration, and examples of successful approaches to evaluate restoration actions programmatically rather than individually drawing on my experience along the West Coast of North America.

Challenges to monitoring restoration success

The challenges in implementing a successful monitoring and evaluation program for river restoration are both technical and non-technical (Roni et al. 2015). Common technical challenges include selecting appropriate monitoring or experimental design, matching monitoring scale to scale of response, selecting treatments and controls, and cost-effective metrics and sampling designs. However, it is often non-technical challenges that cause a monitoring program to fail.

Common non-technical problems include poorly defined goals and hypotheses, inability to control timing, location and scale of restoration; inability to control other management actions, poor training of field staff, data management problems, lack of periodic data analysis and reporting, inadequate coordination with partners, and logistics and funding.

Overcoming key challenges

Most all of the technical challenges can be overcome by following key steps in the monitoring process which include: defining goals and objectives, monitoring hypotheses (questions), monitoring design, monitoring parameters, spatial and temporal replication (sample size), sampling scheme as well as implementing the monitoring and reporting (Figure 1).

Non-technical challenges can be more difficult to overcome as they require skills often not part of the formal education process for scientists such as project management, facilitation, and meeting coordination. Defining clear goals is a non-technical challenge that can be easily overcome by clearly defining and agreeing upon them as first step in the restoration and monitoring process. Other non-technical challenges such as coordination with other agencies and training field crews largely require periodic meetings. Similarly, assuring that a control reach or watershed will remain a “control” and not be restored or subject to other management actions requires extensive, consistent and periodic coordination, meetings and discussions. Based on experience, the amount of time needed for coordination often increases exponentially with the size and complexity of the restoration and monitoring program and the number of entities involved in monitoring and data collection.

Obtaining adequate funding for monitoring and evaluation of restoration and the cost of the monitoring are non-technical challenges that can partly be overcome by judicious selection of parameters for monitoring and consistent reporting. All too often monitoring programs try to use existing standardized protocols designed for other projects, which

can be time consuming and lead to excessive costs. For example, in the US, several monitoring programs to evaluate restoration have adopted existing protocols developed by the US Environmental Protection Agency to evaluate water quality and habitat in small streams. While these are well-established protocol for monitoring water quality, they are time consuming, costly, and measures many parameters that are not sensitive to river restoration actions (Roni et al. 2015).

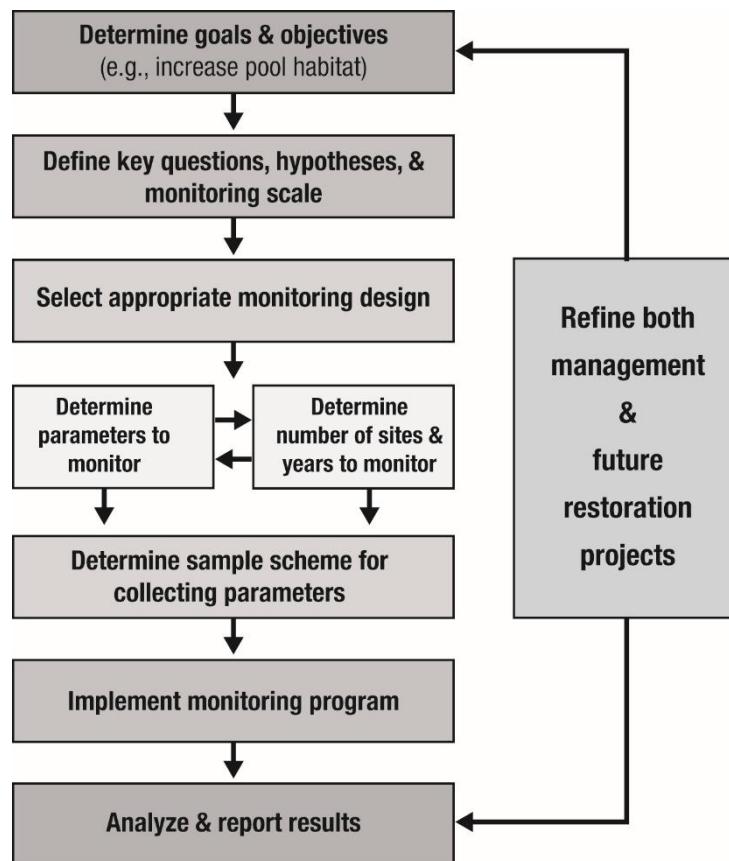

Figure 1. Steps required designing an effective program to monitor and evaluate river restoration success. From Roni and Beechie (2013).

Cost effective approaches for many monitoring parameters have been developed (e.g., some fish abundance, woody debris, channel units), but others are still under development. Most notably, measuring system productivity and effects of changes in food webs on fish production are still being developed (though see Bellmore et al. 2013). Selecting parameters that are: 1) tied to the objectives of the project; 2) relevant to the monitoring questions; 3) sensitive or responsive to the restoration action; 4) efficient to measure; and 5) have limited variability is both technically important but also helps reduce costs. Similarly, not summarizing, analyzing, and reporting results of monitoring on an annual basis can lead to many problems including the inability to identify and correct errors in protocols and data collection, and frustration and distrust with funding institutions and, ultimately, failure of the monitoring program.

Case studies

Two large river restoration monitoring programs in western US provide examples of these challenges and approaches being taken to overcome them. The first, the Action Effectiveness Monitoring (AEM) Program in the Columbia River Basin provides a programmatic approach designed to evaluate fish and habitat response to hundreds of river restoration projects occurring at the reach scale. More than 20,000 habitat restoration projects have been implemented in the Columbia River Basin in the last 20 years. Many restoration projects included funds to monitor restoration success, but this was not a coordinated effort and after spending millions of dollars on monitoring annually for more than a decade, the funding agency could say little about the efficacy of different types of restoration projects. In 2013, using the steps in Figure 1, we developed and implemented a detailed monitoring program to evaluate a subset of both new and completed projects with the goal of developing a consistent, cost-effective monitoring program to evaluate success of different restoration types across the Columbia River Basin. Different study designs, spatial and temporal replication, and protocols are being used for different types of restoration depending upon the scale of restoration response, the frequency of the restoration action (how many projects are implemented per year), and whether pre-project data is needed (Figure 2). Most of the monitoring is being conducted by a third party rather than projects sponsors. Key challenges have been: 1) obtaining a complete list of completed and proposed projects, 2) coordinating field data collection with partners who want to collect their own data, and 3) continued requests from the funding agency to use an existing habitat monitoring protocol that is costly and not well suited for evaluating the success of some restoration types.

The second case study is a network of nearly 20 Intensively Monitored Watersheds (IMWs) across Washington, Oregon, Idaho, and California and British Columbia (Canada) designed to evaluate whole watershed response to restoration (Bennett et al. In press; Roni et al. 2015). These are paired watershed experiments with treatment and control watersheds and intensive monitoring of fish (primarily salmon) and habitat. A loose network of different organizations are implementing both the restoration and monitoring which is costing tens of millions of dollars a year. While all the IMWs have tried to follow a rigorous design process, many have not been meeting their objectives due to several factors including inability to control restoration timing, costly field methods, poor coordination and inadequate funding for either restoration or monitoring. A handful, have been very successful (e.g., Elwha River, Alsea River, Keogh, Bridge Creek IMWs). Those that have been successful have a clear plan for coordination among partners, one entity or individual directing all the efforts, a large amount of restoration that has been implemented in a short period of time, and a well-defined and technically sound monitoring and evaluation program.

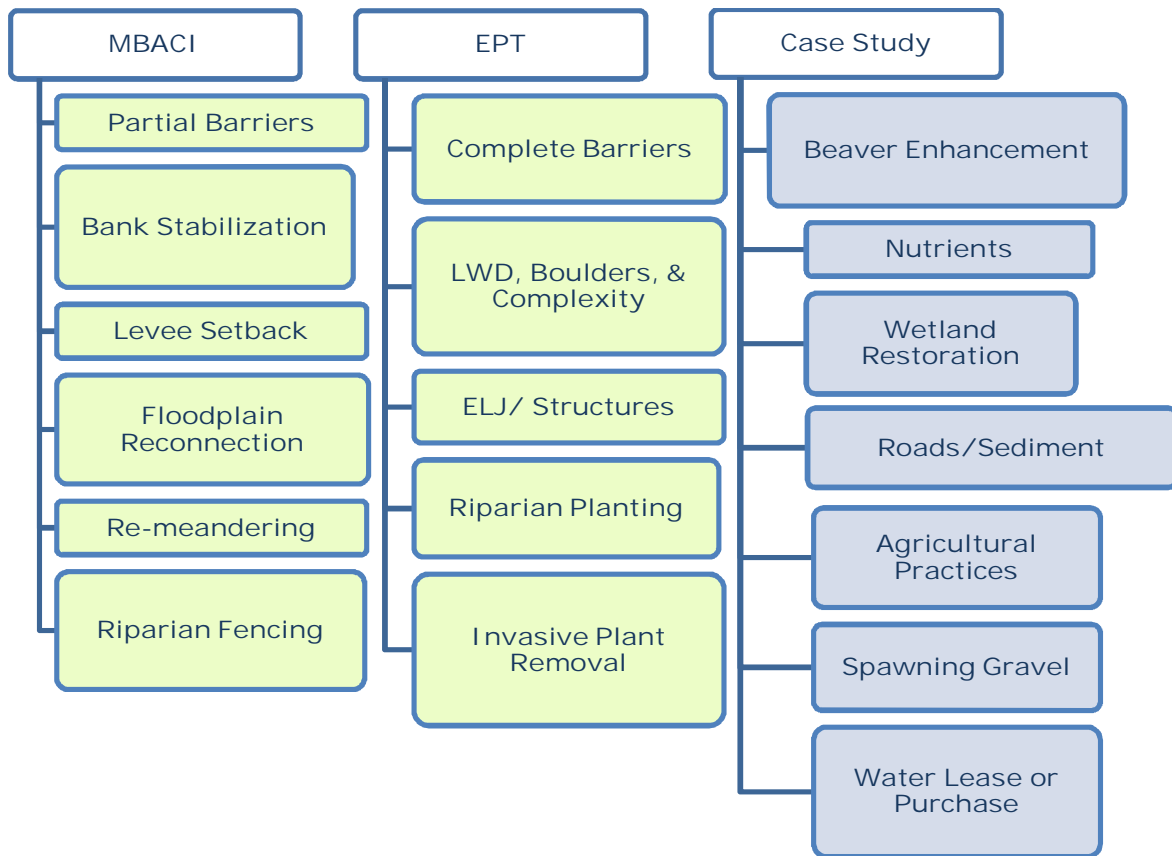

Figure 2. Different study designs being used to evaluate different types of restoration actions across the interior Columbia River Basin. MBACI = multiple before-after control-impact design, EPT = extensive post-treatment design. Both these designs require at least 15 sites with treatment and control pairs. Case studies are detailed research projects designed to evaluate newer techniques or those that have a watershed-scale response. These use either a variety of study designs but typically a before-after or before-after control-impact design with a single pair of control and treatment reaches or watersheds.

Conclusions

Measuring river restoration success requires detailed attention to technical aspects of the monitoring and evaluation program. Equally important are many non-technical aspects related to implementation of restoration, coordination with partners, training of field staff, and analyzing data and reporting results. Failure to adequately manage and address non-technical issues can render even the best designed monitoring program useless. By following the key steps in the monitoring design process (Figure 1) and examples from other successful programs, river restoration can be effectively and efficiently evaluated at a variety of scales.

References

Bellmore R.J, Baxter C.V, Martens K, Connolly P.J. 2013. The floodplain food web mosaic: a study of its importance to salmon and steelhead with implications for their recovery. *Ecological Applications* 23: 189-207

- Bennett S, Pess G, Roni P. et al. (In press). Progress and challenges of testing the effectiveness of stream restoration in the Pacific Northwest using intensively monitored watersheds. *Fisheries* xx: xx-xx.
- Bernhardt E.S, Palmer M.A, Allan J.D., et al. 2005. Synthesizing U.S. river restoration efforts. *Science* 308: 636-637.
- Cunningham S. 2002. *The Restoration Economy*. Berrett-Koehler Publishing, San Francisco.
- Roni P & Beechie T. 2013. Stream and watershed restoration: a guide to restoring riverine processes and habitats. Wiley-Blackwell, Chichester, U.K.
- Roni P, Beechie T, Pess G & Jordan C. 2015. Basin scale monitoring of river restoration: recommendations from case studies in the Pacific Northwest USA. *American Fisheries Society Symposium* 78: 25-50.
- Tarzwell C.M. 1937. Experimental evidence on the value of trout stream improvement in Michigan. *Transactions of the American Fisheries Society* 66: 177-187.
- Thompson D.M & Stull G.N. 2002. The development and historic use of habitat structures in channel restoration in the United States: the grand experiment in fisheries management. *Geographic physique et Quaternaire* 56: 45-60.

Hydromorphic change and biotic response challenge efficient river rehabilitation

Wolter C et al.

CHRISTIAN WOLTER, STEFAN LORENZ, SABINE SCHEUNIG, CHRISTIAN SCHOMAKER
*Leibniz-Institute of Freshwater Ecology and Inland Fisheries, Müggelseedamm 310,
12587 Berlin, Germany*

VANESA MARTINEZ-FERNANDEZ, CARLOS ALONSO, DIEGO GARCIA DE JALON, MARTA GONZALEZ DEL TANAGO
Laboratorio de Hidrobiología, E.T.S.I. Montes. Universidad Politécnica de Madrid, Ciudad Universitaria s/n. 28040 Madrid. Spain

ERIK MOSSELMAN, DIMMIE HENDRIKS
Deltares, Rotterdamseweg 185, 2629 HD Delft, Netherlands

BARBARA BELLETTI
Department of Earth Sciences, University of Florence, Florence, Italy

From an extensive literature review and meta-analyses, this study has i) identified the most important hydromorphological process related to river degradation and rehabilitation, ii) conceptually linked it to evolutionary and functional response chains of aquatic biota, and iii) provided empirical evidence and ecological data for the respective hydromorphological requirements, preferences and limitations of aquatic plants, benthic invertebrates, lampreys, and freshwater fishes.

Introduction

In Europe the water management recently shifted its paradigm from targeting physical and chemical quality to ecological status and integrity. This includes hydromorphology as a key component of river condition and as the main driving force in rivers. Altered hydromorphology is common in river systems. In the United States 44% of 0.9 million river and stream kilometres have been reported impaired (USEPA 2009). Water diversions, channelization, or dam construction are the second major source of impairment in these rivers behind agricultural use. Habitat alteration occurred in 23.2% of the impaired rivers, and flow alteration in 9.7% (USEPA 2009). In Europe, 64% of 1.17 million river kilometres have been reported to hold less than good ecological status (EEA 2012). Hydromorphological changes and altered habitats have been identified as the most widespread pressure on ecological status of EU waters.

By analysing the first River Basin Management Plans (RBMP), EEA (2012) detected a rather weak linkage between status assessment and the definition and implementation of the measures. Although hydromorphological measures have been systematically included in the RBMPs, only half of the latter indicated specific measures to achieve an ecologically based flow regime and about 40% reported a linkage between water uses, types of hydromorphological pressures and specific hydromorphological measures. Further, it was generally not clear how the proposed measures are expected to contribute to the improvement of the ecological status or potential (Lyche-Solheim et al. 2012). Although,

in the past an exponentially increasing number of restoration measures have been implemented to enhance the hydromorphological state of rivers, only very few have been monitored (e.g., Bernhardt et al. 2005, Palmer et al. 2005). The evaluated projects revealed that many measures did not show the desired effects on biota, which might relate to inappropriate scale of measure implementation, confounding impacts of multiple stressors at different spatial scales or insufficient addressing of key elements respectively bottlenecks for target species. In response to the recognized lack of knowledge on the effects of hydromorphological restoration on stream biota, the EU-FP7 project REFORM was drafted building on recent attempts to compile existing data on both, the effects of pressures on hydromorphological processes and variables and the biotic response to hydromorphological degradation and rehabilitation. It has gone beyond recent projects by especially focusing on the specifics of hydromorphology, hydromorphological changes and structures, or features determined by hydromorphology and their linkages to and effects on biota.

Methods

The process-based analysis of impacts relies on understanding systematic relationships between the underlying physical components of hydrology and geomorphology and subsequent biological responses. A bibliographic review has been performed to identify the processes and variables that are associated with the hydromorphological pressures considered. Based on 730 scientific publications reviewed, 15 conceptual schemes have been created showing qualitative interactions between pressures, hydromorphological processes and hydromorphological variables (Garcia de Jalon et al. 2013). Each conceptual scheme was treated as a Fuzzy Cognitive Map (FCM) obtained from scientific literature (according to Özesmi & Özesmi 2004) to identify the most relevant hydromorphological processes and variables. The conceptual schemes link pressures, processes and variables by causal relationships. Responses are visualized by arrows. Arrows received values of -1 for negative relations and +1 for positive. The schemes were then transformed into mathematic adjacency matrices that represent which node of the scheme is adjacent to which other node. All separate matrices (one for each scheme) were then combined into one overall matrix representing a network of all analysed pressures. To combine the schemes, the values of all corresponding arrows were summed up and then normalized by the total number of pressures. Thus, the causal links in the overall matrix are weighted in a continuous range between -1 and +1 according to their importance in the multiple pressure network. As FCMs are based on graph theory models they can be analysed using matrix algebra provided by the graph theory to calculate structural indices. To understand the structure of the system and to identify the most relevant hydromorphological processes and variables the centrality was calculated as a measure of process or variable influence in the network by summing up indegree (cumulative weight of connections entering a variable) and outdegree (cumulative weight of connections exiting a variable). According to Özesmi & Özesmi (2004) the centrality of a variable shows its contribution to the total system, with a high centrality indicating that the variable or process is greatly affecting the system or that the variable or process is being affected by the system.

Assessments of species response and restoration success have to consider ecoregions, biogeographic differences and river types and further require a comparative survey design using reference or control sites respectively before/after samplings. More specific

responses or indications have to be expected if certain taxa depend on specific substrates for feeding or spawning and sensitively react on its losses or gains. However, it is inherent in the nature of rivers as disturbance-dominated, dynamic systems that at very fine spatial scales, e.g. at the level of microhabitats, the number of sensitive indicator species is rather low and the uncertainty of assessment and prediction is high. In river systems, coarse gravel requires a significant stream power to be formed and kept clean. Therefore, coarse gravel beds should indicate functioning sediment transport and sorting and thus, hydromorphologically functioning river stretches. Specialized species that essentially depend on well oxygenated permeable gravel beds for spawning or as refuge provide a direct link to high quality gravel beds and thus, serve as biological indicator for the respective hydromorphological processes. In contrast, typical substrates provided by other than gravel-bed rivers are either not exclusively found in rivers and formed by stream power (e.g. large wood) and thus not indicative for hydromorphology, or there are no species specifically responding to it (e.g. bedrock). However, wood, plant beds, large stones and similarly complex structures provide habitat and shelter and as such they mitigate impacts of physical forces like high flow velocities and stream power on aquatic organisms. Especially the distribution of juvenile and small fish, lentic invertebrates and submerged plants becomes restricted by high flow velocities and shear forces. Accordingly, habitat complexity, habitat structures and connectivity enable habitat utilisation by weak swimmers and fragile taxa. Hence, these structures determine functional responses of aquatic taxa in terms of abundance, species density, diversity and carrying capacity.

Accordingly, the review of biological responses to hydromorphological processes and variables primarily focused on gravel requirements and flow preferences of aquatic macrophytes, benthic invertebrates and fish as well as on their performance thresholds and limitations to withstand higher flow velocities, shear forces and stream power.

Hydromorphological processes and variables

The overall hydromorphological pressures and effects system investigated shows a high complexity value (2.6) indicating that the system results in many outcomes and responses in relation to relatively few forcing pressures. Hierarchy was calculated as 0.0002, which corresponds to the relatively high complexity value and shows that the system is not hierarchical structured. The system had a density value of 0.036 indicating relatively complex causal relationships between pressures, variables and processes in the system compared to the total possible number.

The most central process in the network is the water flow dynamics, followed by vegetation encroachment, and sediment entrainment in order of importance. Although it sounds so trivial that water flowing is an important river process, this result of the meta-analysis is highly relevant for river rehabilitation and management. Despite substantial uncertainties about interaction effects of multiple pressures and different scales, this FCM meta-analysis has simultaneously included all reported pressures and processes in a single comprehensive analysis. And the result showed water flow dynamics as the primary driver of ecological change in altered systems. Hence, it is concluded that the rehabilitation of the natural flow regime should get priority in river rehabilitation.

Linkage to biology

Flowing water as most important process drives sediment erosion, deposition, transport and sorting, and by that provides sediments of certain quality and calibre. Species evolutionary adapted to and essentially depending on using these specific substrates are considered as specific indicators or target species for hydromorphological rehabilitation. Examples include primarily the gravel spawning fish species. Gravel spawning is a life history trait that has evolved in high energy rivers in response to the available habitats and substrates.

The response of aquatic biota to habitat complexity and diversity in relation to stream power is rather unspecific and of functional nature. Structured habitats provide shelter from high flows and high stream power. However, this shelter function is similarly provided by several different habitats structures such as large wood, macrophytes stands or boulders. It is further important to mention that for the provision of shelter these natural features can be substituted by rehabilitation measures, e.g. artificial structures. In principle there are two direct links between hydromorphology and biota, first, the environmentally sensitive gravel spawners reflecting an evolutionary process in response to hydromorphological processes; and second, the carrying capacity in terms of abundance, biomass and diversity as functional response to available resources and habitats.

Biotic response

The review revealed an overall limited autecological knowledge on the life history traits of European freshwater species and accordingly, yielded a rather limited set of specific indicator species that directly respond to hydromorphological integrity in terms of habitat dependence.

Of about 500 macrophytes species, 20,000 freshwater benthic invertebrates species and 550 lamprey and fish species known from Europe, ecological information is published for 176 species, 1118 taxa, 218 species, respectively, including 75, 78, and 218 species, respectively, with reported flow preferences, and 10, 56, and 28 species, respectively, with reported gravel calibre information (Fig. 1, Wolter et al. 2013). However, the relation of autecologically described species and species preferring coarse substrates clearly indicates, that the latter are primarily relevant for fish, while benthic invertebrates and plants rather respond to the physico-chemistry of the water.

The unspecific, functional response to hydromorphology is determined by tolerance thresholds of species, age groups and life stages against high flow velocities and shear stresses, which restrict habitat use up to the complete disappearance of species. Common threshold values of flow velocities reported were <0.3 m/s for species-rich, diverse macrophyte communities (Janauer et al. 2010), 0.3-1.0 m/s for rheophilic invertebrates (Statzner et al. 1988, Söhngen et al. 2008), and 0.1 m/s and 0.5 m/s for hatchlings and juvenile fish, respectively (Wolter & Arlinghaus 2003).

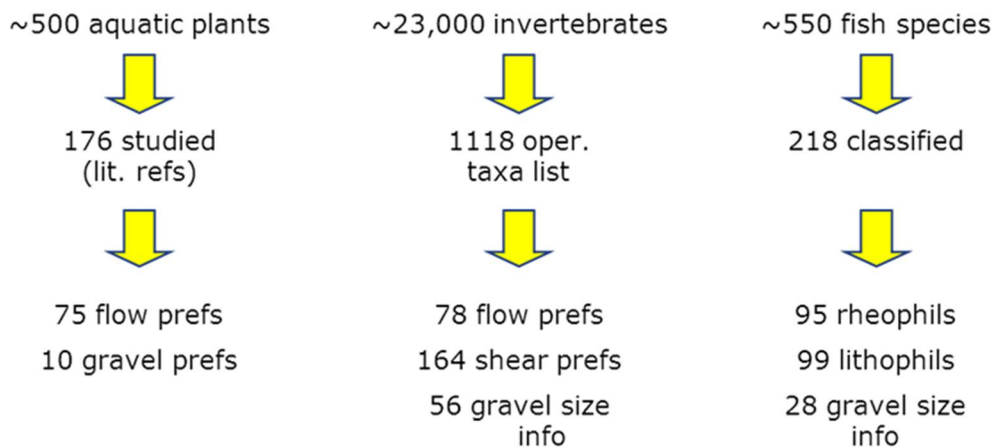

Fig. 1 Summary (number of species) of the reported ecological information for the three studied taxonomic groups.

The functional response is further reflected in the carrying capacity of a river stretch, where diverse and complex habitats support higher densities, e.g. of juvenile fish. In a braided river stretch emerging fish fry was predicted to settle ten times faster in suitable nurseries compared to a regulated single thread reach (Sukhodolov et al. 2009).

In principle, more indicators (species traits, population metrics, juvenile fish, and aquatic plants) are available for the functional response to habitat complexity and diversity, whilst the evolutionary response to coarse gravel substrates as result of hydromorphological processes is mainly expressed by lithophilic fish (Wolter et al. 2013). Benthic invertebrates were found intermediate responding with significant influence of water quality (Wolter et al. 2013).

Conclusions

Among all simultaneously interacting pressures and processes flowing water has been identified as the most relevant. Accordingly, river rehabilitation should primarily focus on rehabilitating natural flow dynamics and related processes. The biotic response to hydromorphological changes, degradation and rehabilitation is mainly related to habitat complexity and coarse substrates. The functional response was found most pronounced for aquatic plants, juvenile fish, and the fish assemblage as a whole; while a specific response was especially obvious for lithophilic fish. Accordingly, the responding taxa, age groups and life history traits identified should also serve as rehabilitation targets.

Acknowledgements

The work leading to this report has received funding from the EU's 7th FP under Grant Agreement No. 282656 (REFORM).

References

- Bernhardt ES, Palmer MA, et al. (2005). Synthesizing U.S. river restoration efforts. *Science* 308: 636-637.
- EEA (2012). European waters – assessment of status and pressures. European Environmental Agency, Copenhagen, EEA Report No 8/2012.

- Garcia de Jalón D, Alonso C, et al. (2013). Review on pressure effects on hydromorphological variables and ecologically relevant processes. REFORM Deliverable D1.2, Report to the European Union. (available at <http://reformrivers.eu/>)
- Janauer GA, Schmidt-Mumm U, et al. (2010). Aquatic macrophytes and water current velocity in the Danube River. *Ecological Engineering* 36: 1138-1145.
- Lyche-Solheim A, Austnes K, et al. (2012). Ecological and chemical status and pressures in European waters. European Topic Centre on Inland, Coastal and Marine Waters, Prague, ETC/ICM Technical Report 1/2012.
- Özesmi U, Özesmi SL. (2004). Ecological models based on people's knowledge: a multi-step fuzzy cognitive mapping approach. *Ecological Modelling* 176: 43–64.
- Palmer MA, Bernhardt ES, et al. (2005). Standards for ecologically successful river restoration. *Journal of Applied Ecology* 42: 208-217.
- Söhngen B, Koop J, et al. (2008). Considerations to Reduce Environmental Impacts of Vessels. Brussels: PIANC, PIANC Report 99.
- Statzner B, Gore JA, et al. (1988). Hydraulic stream ecology: observed patterns and potential applications. *Journal of the North American Benthological Society* 7: 307-360.
- Sukhodolov A, Bertoldi W, et al. (2009). Implications of channel processes for juvenile fish habitats in Alpine rivers. *Aquatic Sciences* 71: 338-349.
- USEPA (2009). National Water Quality Inventory: Report to Congress. 2004 Reporting Cycle. United States Environmental Protection Agency, Office of Water, Washington, DC.
- Wolter C, Arlinghaus R. (2003). Navigation impacts on freshwater fish assemblages: the ecological relevance of swimming performance. *Reviews in Fish Biology and Fisheries* 13: 63-89.
- Wolter C, Lorenz S, et al. (2013). Review on ecological response to hydromorphological degradation and restoration. REFORM Deliverable D 1.3, Report to the European Union. (Available at <http://reformrivers.eu/>)

4. ASSESSMENT AND REHABILITATION OF HYDROMORPHOLOGICAL PROCESSES IN RIVERS

Development of a system for the classification of geomorphic units aimed at characterizing physical habitats and stream morphology

Belletti B et al.

BELLETTI BARBARA¹, RINALDI MASSIMO¹, COMITI FRANCESCO², NARDI LAURA¹,
MAO LUCA³, BUSSETTINI MARTINA⁴

¹*Department of Earth Sciences, University of Florence.*

²*Faculty of Science and Technology, Free University of Bozen-Bolzano, Italy.*

³*Pontificia Universidad Católica de Chile, Chile.*

⁴*Institute for Environmental Protection and Research (ISPRA), Italy.*

barbara.belletti@unifi.it

In this paper we briefly illustrate a system for the classification and survey of geomorphic units (GUS, Geomorphic Units survey and classification System). This aims at characterizing physical habitats and stream morphology, and is suitable for integrating the hydromorphological assessment at the reach scale.

Keywords: Field survey, Geomorphic units, Hydromorphological conditions, Physical habitats, Remote sensing

Introduction

The assessment of stream hydromorphological conditions is required for the classification and monitoring of water bodies by the Water Framework Directive 2000/60, and is useful for establishing links between physical and biological conditions. The spatial scale of geomorphic units and related smaller units (hydraulic, river elements) are the most appropriate for defining these links, since geomorphic units represent the physical template for physical habitats.

Since the 1980s, several methods have been developed worldwide for the survey or assessment of physical habitats. Recently it has been shown that physical habitat methods used across Europe for the WFD are affected by a series of important limitations (Belletti et al., 2015). First, there is a remarkable difference between the terminology used, and the present state of the art in fluvial geomorphology. Secondly, in most methods the spatial scale of investigation is not well framed within a multi-scale approach being, rather, on a small ('site') scale and of a fixed length. Lastly, the high status/reference condition is often defined on the basis of the presence and abundance of features, failing to recognize the 'natural' variability of geomorphic structures amongst different river types.

In this context, a new system for the survey and classification of geomorphic units (GUS, Geomorphic Units survey and classification System) in streams and rivers has been developed. The system is fully incorporated in the multi-scale, hierarchical framework for the analysis of river hydromorphology developed within the context of the REFORM project (REstoring rivers FOR effective catchment Management) and refers to the spatial scales of geomorphic units below the reach scale. This system is part of a wider set of

new tools for an overall hydromorphological assessment of European streams (see Rinaldi et al., 2015). In particular, the GUS is suitable for integrating the Morphological Quality Index (MQI) developed in Italy (Rinaldi et al., 2013) and recently expanded to other European countries in the context of REFORM.

The geomorphic units survey and classification system

Basic principles

The overall characteristics of the GUS can be summarized as follows:

- The method is designed to provide a general framework for the survey and classification of geomorphic units, while it does not aim to assess the deviation from any given reference conditions and/or assess the status or quality of the stream by the use of synthetic indices.
- It is an open-ended, flexible framework, where the operator can set up the level of characterization and the specific focus of the survey, depending on the objectives and on available resources.
- The system is embedded in an appropriate, spatially nested hierarchical framework.
- The analysis of geomorphic units can be inserted in a wider spatial-temporal framework of the analysis of morphological conditions (e.g. Brierley et al., 2013). Indeed, the information collected can be used to better understand the morphology of a given reach and to support the analysis of river reach behavior and evolution.
- The information collected may allow the establishment of a link between the river hydromorphology at the reach scale and the biota.

The spatial scales of the GUS

Geomorphic units are organized in three different spatial scales, as follows:

- (1) Macro-unit: this is an assemblage of units of the same type (e.g. aquatic portions, sediment, vegetation). The spatial scale of Macro-units is the reach or the sub-reach.
- (2) Unit: this represents the basic spatial unit (i.e. the 'true' geomorphic unit), and corresponds to spatial features having distinct morphological characters and significant size (e.g. a riffle, a bar, an island, etc.).
- (3) Sub-unit: this is a portion of a geomorphic unit which is relatively homogeneous in terms of sediment, vegetation, or hydraulic conditions.

Units and Sub-units correspond to the mesohabitat scale. Small Sub-units can also correspond to the microhabitat scale (i.e. river elements). These spatial units are analyzed at the reach or sub-reach scale, where the latter must be representative of the geomorphic units that characterize the morphology at the reach scale.

Spatial settings

The overall spatial domain of application of the GUS is potentially the entire alluvial plain. Usually the main focus of the survey is on the area of the fluvial corridor that is most frequently affected by fluvial processes (i.e. the relatively natural corridor of spontaneous vegetation). Within this area, three different spatial settings are distinguished:

- (1) The bankfull channel: this groups all the geomorphic units within the bankfull channel, both 'submerged' (bed configuration, aquatic vegetation) and 'emerged' (bars, islands, large wood jam) units.
- (2) The marginal or transitional zone: this includes all the geomorphic units located between the bankfull channel and the floodplain (e.g. banks, benches).

(3) The floodplain: this concerns the geomorphic units located beyond the banks (e.g. modern floodplain, recent terrace, wetlands, oxbow lakes, etc.). The size of these units is generally larger than units within the bankfull channel and the marginal zone.

Methods and levels of characterization

The survey of geomorphic units is carried out by combining remote sensing analysis and field survey, according to the spatial scale and the level of characterization.

Different levels of characterization can be applied, depending on the aims of the survey: Broad, Basic, and Detailed level. At each level specific information is collected: from the simple census of unit types and their number (Broad and Basic level), to the measurement of the units' sizes and the survey of specific unit characteristics (e.g. sub-types, sediment, hydrology, vegetation; Detailed level) (Figure 1).

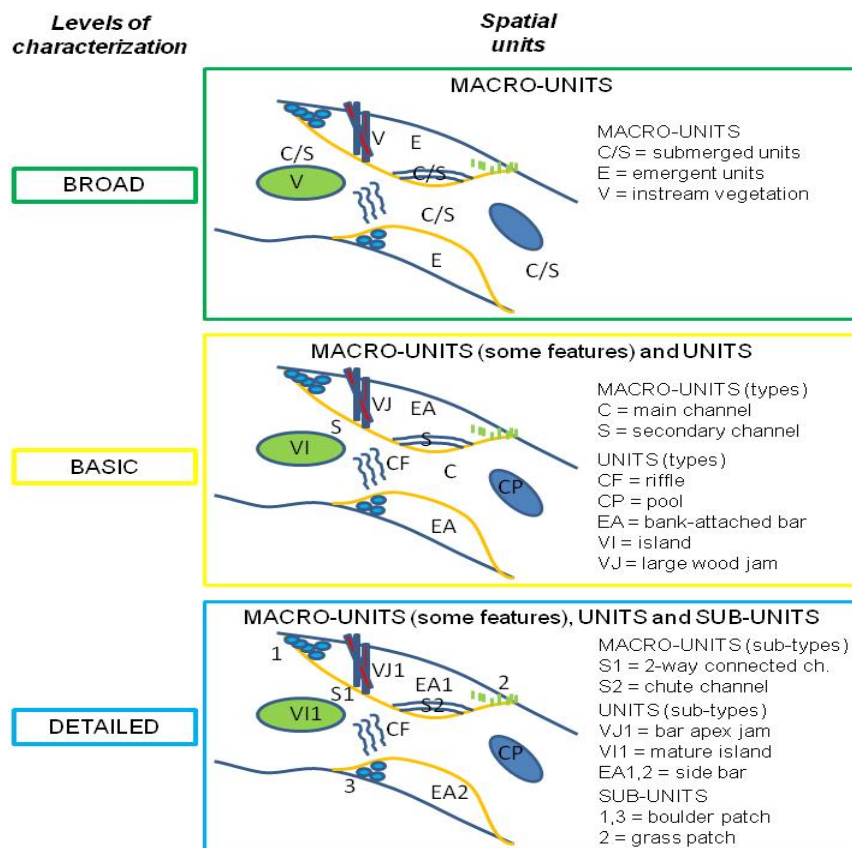

Figure 1. Levels of characterization and spatial units; examples of geomorphic units (types and sub-types) for different spatial contexts are also reported.

The GUS is applicable to most fluvial conditions (e.g. from small streams to large rivers), and has been designed to be flexible and adaptable (i.e. including mandatory and/or optional sections) on the basis of specific objectives (e.g. reach characterization, assessment, monitoring) and available data (e.g. image resolution).

The analysis of the geomorphic units

The GUS does not aim to provide an assessment of the status of geomorphic units or a reach. It can, however, support the overall morphological analysis of a given reach. In particular, it can be useful (i) as a characterization tool of the reach morphology; and (ii)

as a monitoring tool, in order to detect small scale (temporal and spatial) morphological changes induced by human interventions or restoration actions.

To this purpose, two indices have been developed, aiming to synthetically describe the spatial heterogeneity of a given reach in terms of geomorphic units, using data collected at the Basic level (presence and number of Units and Macro-units). The Geomorphic Units Richness Index (GUSI-R) evaluates how many types of geomorphic units and Macro-units (e.g. bar, island, riffle, secondary channel) are observed within a given reach, and is obtained by dividing the sum of all unit types with the maximum number of possible unit types. The Geomorphic Units Density Index (GUSI-D) calculates the total number of geomorphic units (independently by types) within the reach per unit length. It is also possible to calculate a series of sub-indices expressing the richness and density of geomorphic units for each spatial setting (bankfull and floodplain, including the marginal zone) or Macro-unit (in the latter case only the GUSI-D is calculated in respect to each Macro-unit area).

It is important to highlight that the results obtained by the GUS (including indices) must always be contextualized within the overall morphological conditions and within the trajectory of evolution of the analyzed reach.

Applications of the gus

Application fields

The data and information collected with the GUS are useful for several applications, as follows:

- (i) Spatial and temporal analyses of geomorphic units at different spatial scales:
 - Survey and characterization of physical habitats at the meso (Units, Sub-units) and micro (substrates, flow types, etc.) scales, as well as analysis of the fluvial landscape at the Macro-unit scale; these can be carried out by calculating diversity indices (e.g. Shannon, richness, dominance, etc.) and metrics for the landscape description (e.g. patch form, connectivity, ecotones length, etc.).
 - More detailed characterization of the morphology at the reach scale and its evolution through time.
 - Monitoring of the geomorphic units across time, in order to assess the effect of interventions (e.g. restoration) or of natural disturbances.
 -
- (ii) Analyses of the relationships between geomorphic units (i.e. physical habitats) and biota:
 - As a physical basis for biological surveys at a scale that is geomorphically-meaningful.
 - As a key tool in order to provide a link between the morphological status at the reach scale and the biological status at the site scale.
 - As a tool for the survey and mapping of the mesohabitat in order to: (i) apply habitat simulation models for the fauna (e.g. MesoHABSIM, Parasiewicz et al., 2013); (ii) calculate the spatio-temporal variation of habitats for the fauna (e.g. Vezza et al., 2014).

Example of application

The GUS has been applied to an unconfined reach of the Cecina River, located in Central Tuscany (Central-Northern western Italy). The Broad level was applied to the entire reach length (6.5 km) and to two sub-reaches (about 1.5 km length), whereas the Basic level was only applied to the two sub-reaches. The survey of geomorphic units was carried out by remote sensing of high resolution images (< 30 cm); a field check was also conducted. Figure 2 shows an example of the output of the survey and classification of geomorphic units at the Basic level (only one sub-reach is displayed). Table 1 summarizes the results of the GUS indices and sub-indices for the sub-reach in Figure 2.

Table 1. Summary of the GUS indices and sub-indices (for each spatial setting) for the sub-reach in Figure 2. GUSI-R, Geomorphic Units Richness Index; GUSI-R_{BC}, richness sub-index for the bankfull channel; GUSI-R_{FD}, richness sub-index for the floodplain; GUSI-D, Geomorphic Units Density Index; GUSI-D_{BC}, density sub-index for the bankfull channel; GUSI-D_{FD}, density sub-index for the floodplain.

<i>GUSI-R</i>	0.38	<i>GUSI-D</i>	73.6
<i>GUSI-R_{BC}</i>	0.26	<i>GUSI-D_{BC}</i>	63.6
<i>GUSI-R_{FD}</i>	0.12	<i>GUSI-D_{FD}</i>	10

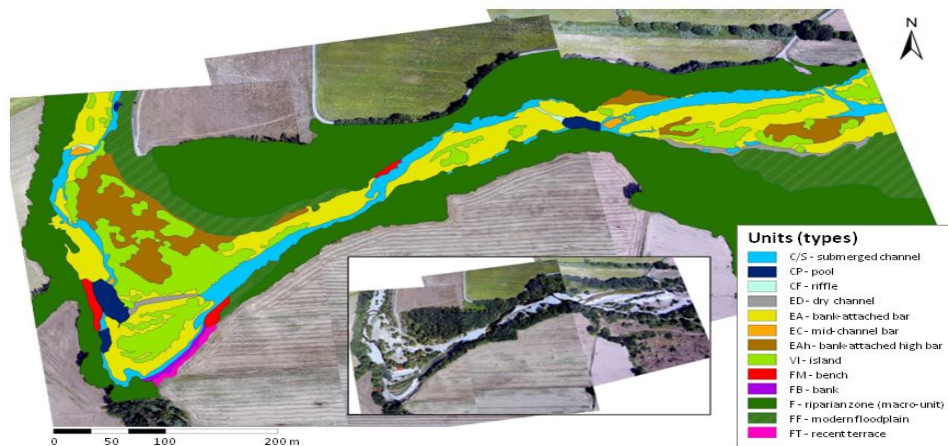

Figure 2. Example of the application of the GUS to the Cecina River (Basic level): map of the types of geomorphic units in one of the sub-reaches.

Acknowledgments

This work has received funding for the EU’s FP7 under Grant Agreement No. 282656 (REFORM), whereas the original Italian version of the methods was funded by ISPRA (Istituto Superiore per la Protezione e la Ricerca Ambientale, Roma).

References

Belletti, B., Rinaldi, M., Gurnell, A.M., Buijse, A.D. and Mosselman, E. (2015). A review of assessment methods for river hydromorphology. *Environmental Earth Sciences* 73: 2079-2011. doi: 10.1007/s12665-014-3558-1

Brierley, G.J., Fryirs, K., Cullum, C., Tadaki, M., Huang, H.Q., Blue, B. (2013). Reading the landscape: integrating the theory and practice of geomorphology to develop place-based understandings of river systems. *Progress in Physical Geography* 37(5): 601–621

- Parasiewicz, P., Rogers, J.N., Vezza, P., Gortazar, J., Seager, T., Pegg, M., Wiśniewolski, W., Comoglio, C. (2013). Applications of the MesoHABSIM Simulation Model. In: Maddock I., Kemp P., Wood P. (ed.), *Ecohydraulics: an integrated approach*. John Wiley & Sons Ltd, pp. 109-124
- Rinaldi, M., Belletti, B., Bussettini, M., Comiti, F., Golfieri, B., Lastoria, B., Nardi, L., Surian, N. (2015). New tools for an integrated hydromorphological assessment of European streams. REFORM Deliverable D7.5, Final conference - submitted abstracts (this volume)
- Rinaldi, M., Surian, N., Comiti, F. and Bussettini, M. (2013). A method for the assessment and analysis of the hydromorphological condition of Italian streams: The Morphological Quality Index (MQI). *Geomorphology* 180-181: 96-108
- Vezza, P., Goltara, A., Spairani, M., Zolezzi, G., Siviglia, A., Carolli, M., Bruno, M.C., Boz, B., Stellin, D., Comoglio, C., Parasiewicz, P. (2014). Habitat indices for rivers: quantifying the impact of hydro-morphological alterations on the fish community. G. Lollino et al. (eds.), *Engineering Geology for Society and Territory*. Volume 3, Springer International Publishing Switzerland 2014, DOI: 10.1007/978-3-319-09054-2_75

Sediment is not a problem

Detering M & Bartelt D

MICHAEL DETERING & DIETRICH BARTELT

DB Sediments, Bismarckstr. 142, 47057 Duisburg, Germany.

m.detering@db-sediments.com

Every year almost 2 % of worldwide reservoir volume is lost due to sedimentation. This loss is not even compensated by the actual new build of dams, in many cases making reservoirs not sustainable. By 2050, more than 25 % of all reservoirs will be inoperable due to sedimentation. Thus sedimentation becomes a major problem for those who do not take sedimentation into account at an early stage or ignore sedimentation effects too long. An additional issue are massive methane/GHG emissions from reservoir and dammed river sediments. The other side of sedimentation is missing sediment downstream, leading to massive erosion in rivers. The German River Rhine alone faces a sediment deficit of 2.5 million tons per year due to sediment retention in its tributaries reservoirs. Even massive and extremely costly addition of "artificial" sediment does not catch up with annual significant bed erosion. Conventional approaches to deal with the problem are either giving up a reservoir, perform strongly questionable flushing or to do costly dredging and landfill, if at all applicable. To distract sediment from the streaming river or to abruptly silt up river reaches cause other problems and lead to further cost and environmental impacts. But in recent years, a competitive and environmental friendly technique of continuous sediment transfer has been developed and also successfully implemented in practice. Sediment transfer is restored in a near nature way, at the same time providing maximum cost efficiency. Ecological benefits evolved in short time and reservoir storage capacity is restored and maintained. By not taking sediment as a problem but as a natural condition to deal with, a sustainable and advantageous solution can be gained with great success.

Introduction

In natural rivers, passage of water, species and sediment was granted for millions of years. Upon the construction of dams, this situation changed profoundly. Every dam and reservoir - built for a reasonable and well considered technical use – also implies an interruption for water flow, fish passage and foremost of sediment transfer. Hydrology is well considered in reservoir planning. For low level dams fish passage techniques are well established, for high dams in most cases it is no issue. But sediment transfer in many cases is still neglected, despite the large problems evolving from this.

The two sides of sediment

Sedimentation of reservoirs

Sooner or later every reservoir or dammed river is faced with sedimentation. As long as this takes place within the dead storage, the operator might not feel the need for action. But even then, the downstream river stretch is affected as described in 2.2.

As soon as the sedimentation is reducing the active storage, also the reservoirs use and thus the economics are affected. Because sedimentation is a sneaking process, the problem of reduced storage is often transferred from generation to generation of responsible staff, always considered 'normal'. Psychologists refer to this development as

'shifting baseline'. However, even under these circumstances operational and contractual obligations have to be met, e.g. sufficient storage to ensure reserves, black start capability etc.

As conventional dredging is extremely costly and landfill is – if at any possible – a further consumption of space, operators often accept sedimentation as long as possible. The consequence of this development is shown in Figure 1.

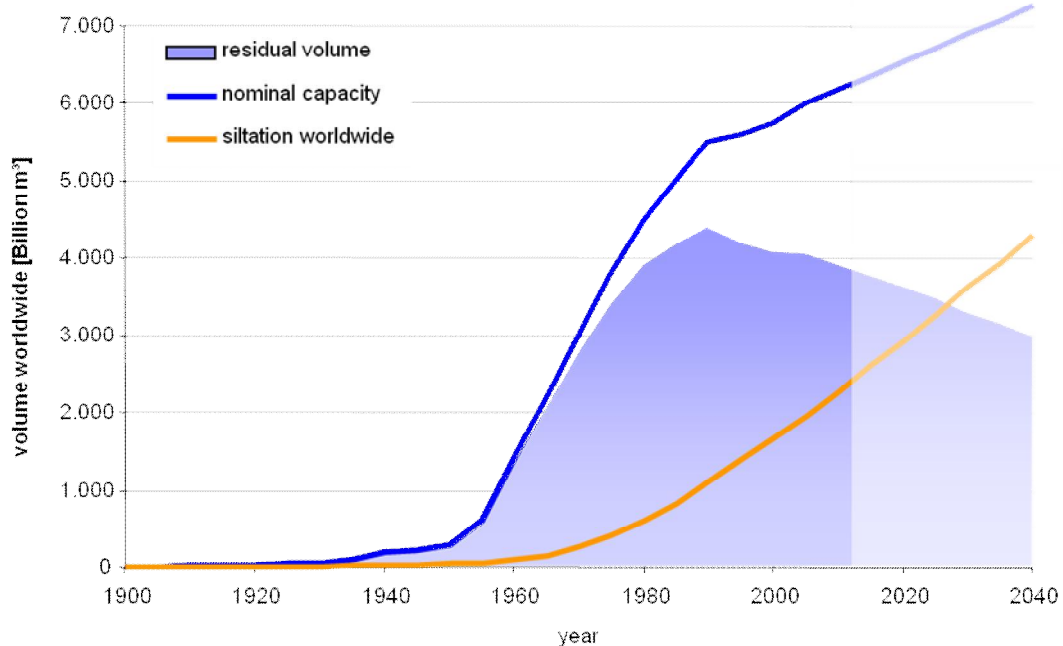

Figure 1. Worldwide development of reservoirs and siltation (Source: DB Sediments).

Worldwide hydro storage volume is increases around 1 % per year by new build of dams. At the same time 2 % of reservoir volume is lost due to sedimentation. As Fig. 1 clearly shows, this development is progressing. Without further action one quarter of all dams in the next 25 to 50 years will lose their storage function by sedimentation [WCD 2000]. Sedimentation is probably the most serious technical problem faced by dam operators. In addition to this, the large scale effects of climate gas emissions from silted reservoirs and dammed rivers came into focus to a broader public [Lorke].

As an assumed solution or compensation, many silted reservoirs are replaced by new build of more reservoirs. But this is clearly not sustainable as the replacements will suffer the same problems only few decades later. Then at the latest, room for even more reservoirs will not be available in some decades.

So far, operators tend to flush out sediment. For some installations, this might be adequate if the downstream river does not bear any significant aquatic life. For the most rivers, reservoir flushing causes the temporary coating of downstream river stretches with often sediment of anaerobic quality. During flushing, hydraulics usually allow only sediment close to the outlet or in a narrow ditch to be mobilized. The sediment volume being mobilized is thus only a small fraction of the overall siltation. The focus on flushing therefore is not on re-gaining storage volume, but to keep the outlets operational before blocking becomes an irreversible problem.

As the flushing is being conducted during just a short time period of usually several hours and the sediment transfer during this period is massive, the sediment transport capacity of the downstream river as well as the rivers ability to handle a massive load of anaerobic sediment is overstrained. Flushing therefore in many cases is to be avoided from an ecological standpoint and unlawful in most European Countries.

Downstream river erosion

Sedimentation in reservoirs and dammed rivers does not lead only to problems within the reservoir or river stretch. Due to the retention of sediment the important equilibrium within the river system is disturbed. The lack of sediment in the downstream river causes a change of the bed structure and massive erosion of the riverbed. This erosion can lead to immense scale. The River Rhine e.g. faces a sediment deficit of 2.5 million tons per year due to sediment retention in its tributaries. One consequence is an annual erosion of 3 to 30 mm. Within only a few decades this will lead to required measures on harbors along the Rhine and major construction works to ensure structural safety of hydro and waterway installations. To compensate for the most urgent damages on the riverbed the authorities actually dump several hundred thousand tons of substitute material which is excavated on land and which leads to further consume of land space.

For these reasons the European Water Framework Directive (WFD) has identified not only fish passage and hydrology, but also sediment transfer as a major aim, being emphasized within the second WFD planning period. Unlike other elements of the WFD, operators should understand that sediment transfer does bear long term cost benefits, if applied in the right way.

Solutions

It could all be so easy. And in fact, it is. It begins with changing the view from considering sediment a problem towards simply dealing with sediment as a standard issue for reservoir or dammed river operators. If reservoirs cause an imbalance in the sediment transport, combined with problems upstream and/or downstream, why not set this balance back where it belongs, especially if this can be done in a very efficient way?

Analysis

As the hydrological and sediment situation varies from reservoir to reservoir or river, the first step to develop a cost efficient sediment transfer should be to conduct a study. If required, an actual bathymetry is performed. Most important part of the analysis is to identify technical and environmental constraints with the core element being to assess the transport capability of the downstream river stretch. The analysis also gives information about the kind of applicable equipment and dimensioning.

Implementation

Given this information, the practical implementation can be prepared and installed. A main difference to formerly dredging and landfill is that not disposal cost occur, transportation is limited and the overall installation and application usually can be performed without lowering the reservoir or even interrupting power generation. Mechanical dewatering of the sediment is of course unnecessary, too (sample see Fig. 2).



Figure 2. Continuous Sediment Transfer at HPP Rodund/Austria (source: DB Sediments).

In difference to dredging campaigns or flushing, the sediment outflow is not massive during a short time, but smaller over a longer time period. This allows for smaller equipment compared to conventional approaches (sample see Fig. 3).



Figure 3. Sample for Sediment Transfer Equipment.

The sediment transfer is performed according to the actual transport capability of the river. Thus, blocking of the riverbed system is prevented. If required, the transferred sediment can also be vented to prevent a lack of oxygen in case of massively anaerobe sediments. The sediment is given back to the river system in a near-nature-way, allowing for erosion compensation and sustainably conducted as a permanent installation.

Technical issues

Sediment transfer to the downstream river section can take place in different ways, either through the turbines/power station, through the base outlet or similar outlets or over the dam.

One of the first glance, some engineers fear the effects on sediment on turbine abrasion if sediment is transferred across the power station. Damage on turbine equipment can amount to a hundred thousand Euros and more. On the second glance a transfer across the turbine for many applications still is the favorable one for several reasons:

- additional abrasion usually is no or limited concern for heads below 200 m
- expenditures for turbine rehabs or even runner replacements sum up to just a fraction of the cost saved in difference to conventional dredging
- modern coating gives protection to runner surfaces (see Fig. 4)
- no water is wasted for sediment transfer



Figure 4. WC-coated Francis Runner and its labyrinth seal after passage of 159,000 t of abrasive sediment without significant abrasion effects (source: University of Katmandu).

In case there are still concerns on a turbine passage, the sediment flow can also be performed via other reservoir outlets or over the dam. However, in these cases often additional equipment will be required which in the end still gives economic benefit.

Recommendations

With a different view on sedimentation issues, responsible people on the one hand will find more economic solutions on reservoir/river maintenance and provide real sustainability for their river or reservoir. By this, sediment transfer might be the only part of the European Water Framework directive, granting a direct economic benefit. On the other hand sediment transfer re-establishes an urgently needed compensation for ongoing erosion for downstream river stretches, caused by a lack of sediment in these river sections.

Ongoing projects will ease the way to establish this ecological benefit as a standard solution, also due to the lack of alternatives on many sites, according to: "If you think sediment transfer is costly - try siltation."

References

- Schüttrumpf, H. and Detering, M.: Innovative sediment handling to restore reservoir capacity, Dams and reservoirs under changing challenges / Ed. by Anton J. Schleiss, ISBN: 978-0-415-68267-1, pp 345- 352, 2011, CRC Press.
- WCD: The Report of the World Commission on Dams, London/Sterling, Earthscan Publications (2000).
- Lorke, A. et al. (2013): Sediment Trapping by Dams Creates Methane Emission Hot Spots, Environmental Science and Technology 2013, 47, 8130-8137.

Reach Scale Floodplain Reconnection and Restoration: Achieving the Objectives of the Columbia River BiOp

Drury T, Gaffney J & Fisher B

TRACY DRURY¹, JOHN GAFFNEY¹ & BRIAN FISHER²

¹*Anchor QEA, LLC, Bellingham, Washington, United States of America.*

²*Methow Salmon Recovery Foundation, Twisp, Washington, United States of America.*

The M2 (Middle Methow) Floodplain Reconnection and Restoration Project is located within the Methow River between Winthrop and Twisp, Washington, encompassing the recent, historic floodplain and included side channels, wetlands, and disconnected aquatic habitats. Phase I implementation was completed in 2013 and 2014, and preliminary monitoring results have shown over a 100% increase in Endangered Species Act (ESA)-listed juvenile fish use within the reach. Two segments of the river were targeted for Phase I implementation based on the presence of available floodplain, side channels, alcoves, and disconnected habitats. Although the two sites appeared similar in planform and shared many objectives, such as increasing connectivity and complexity of existing side channels, improving riparian conditions, and enhancing floodplain connectivity, they were quite different in process: one channel was contracting and went dry during the summer low-flow period, while the other was expanding and countermeasures had been taken to impede avulsion. Therefore, the design analyses evaluated differing critical parameters when determining an appropriate, sustainable design.

Introduction

The Methow River originates in the North Cascades of Washington State and drains into the Columbia River near Pateros, Washington. The catchment at the project reach drains over 1,000 square miles (2,600 km²) and produces a wide range of flows over the typical annual hydrograph. In the project reach, low summer and winter flows are typically around 300 cfs (8.5 cms). The 2-year return period flow is around 9,500 cfs (269 cms) and typically occurs during spring snow melt. The 100-year return period flow is estimated at 29,600 cfs (383 cms). The bank-full width of the river in the project reach varies between 250 and 300 feet (76 and 91 m). The average river gradient through the project reach is 0.3%. Bedrock outcrops exist in several locations within the project reach along the banks and the riverbed, while in other areas the bedrock is located well below the surface. The remnants of alpine and continental glaciation are observed within the valley as high glacial outwash terraces. Unlike many Pacific Northwest river systems where floodwaters occupy much of the floodplain at a frequency of every 2 to 5 years, the Methow River in the project reach would only begin to overtop the banks in a few places during the 5-year flood, but typically does not have significant floodplain connectivity until the 10-year to 25-year event.

The Upper M2 Reach supports all three ESA-listed salmonid species (spring Chinook [*Oncorhynchus tshawytscha*], steelhead [*O. mykiss*], and bull trout [*Salvelinus confluentus*]) throughout all or a portion of their life history stages (Figure 1); Pacific Lamprey has been identified as a priority species of concern.

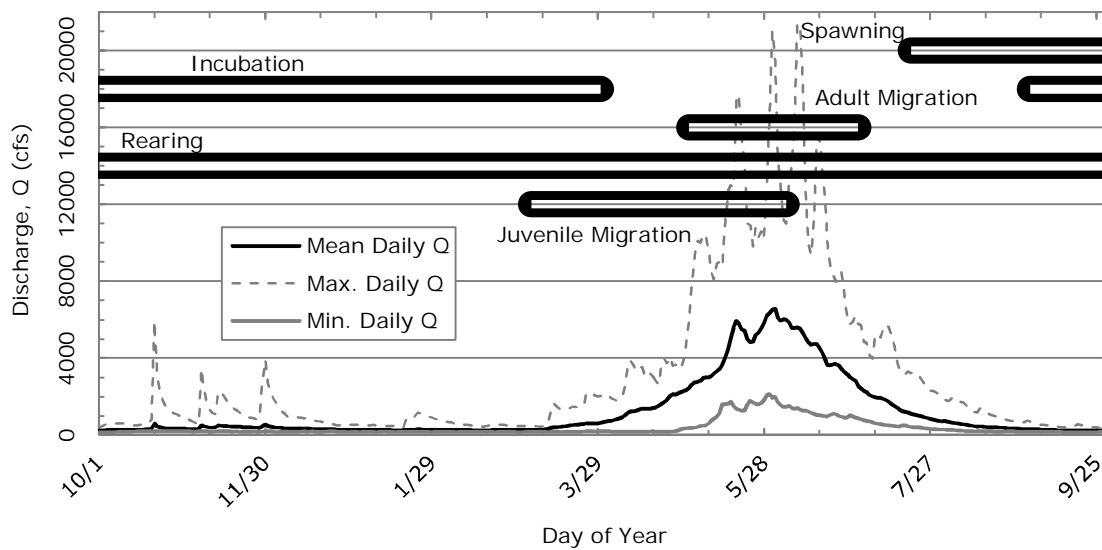

Figure 1. Typical life stage timing of spring Chinook in the project area.

Alternatives Evaluation

Alternative development was a collaborative effort: the key participants in the Upper M2 Reach design team consisted of the United States Bureau of Reclamation (USBR), Methow Salmon Recovery Foundation (MSRF), and Anchor QEA, LLC. Project alternatives were developed to address benefits to viable salmon populations (VSP) and address limiting factors in the reach. Consideration was also given to boater safety and known landowner concerns. Each alternative focused on adding hydraulic complexity to the side channel and increasing the benefits of the existing side channel and floodplain habitat for salmonids throughout the annual flow regime. The conceptual alternatives developed for the current scope of work were evaluated using a wide range of qualitative and quantitative analyses in order to understand the potential benefits and impacts of the projects. Selecting a preferred alternative was a collaborative effort among the Upper M2 Reach design team, including Anchor QEA, USBR, and MSRF. Stakeholder, landowner, Regional Technical Team, and public outreach input also played a significant role in the selection of some project elements.

Project Design

Following the selection of the preferred alternative, engineering design was completed by Anchor QEA in conjunction with USBR and MSRF for the two project sites. The design analyses completed for the proposed structures include scour, stability, buried rootwad stability analyses, and river user safety. Forces considered in these analyses include structure and log buoyancy, structure and log weight, upstream and downstream hydrostatic forces, friction, velocity, drag, ballast, and the resisting forces of the substrate. These design calculations were used to set footprint elevations and to determine the stability of each of the structures and the resulting factors of safety that apply to the structure. Most of the structures were designed to withstand the hydraulic conditions for the modeled 100-year return period event.

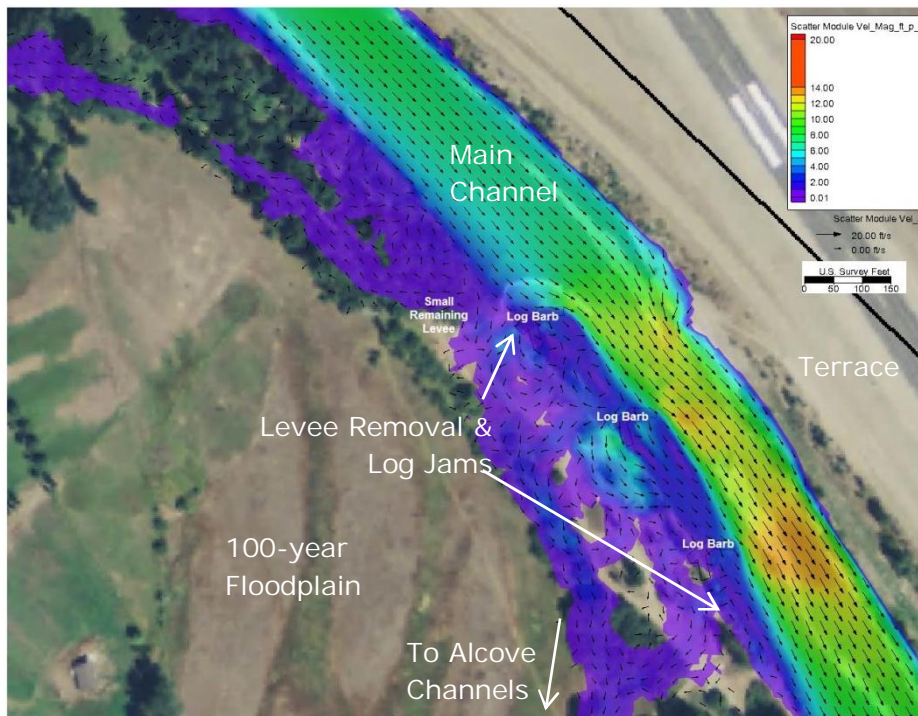

Figure 2. 2-D modeled water depth and velocity vectors at a 2-year event for as-built conditions following levee removal and log jam construction. Colors show water depth and arrows are velocity vectors.

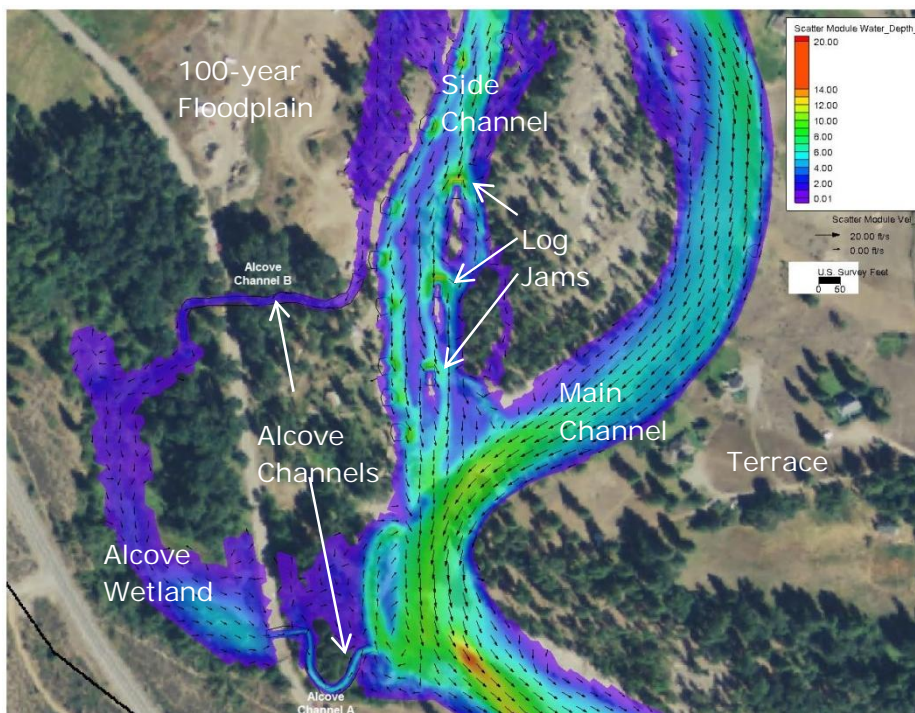

Figure 3. 2-D modeled water depth and velocity vectors at a 2-year event for as-built conditions following log jam installation, alcove channel development, and culvert replacement. Colors show water depth and arrows are velocity vectors.

To support the design development and design analysis calculations, a 1-D Hydraulic Engineering Center–River Analysis System (HEC-RAS) model was used. Additionally, a 2-D model (SRH-2D) was developed for proposed and as-built conditions to evaluate floodplain flow paths and velocity vectors at structures (Figures 2 and 3).

Implementation

Floodplain connectivity was increased at multiple levels, from improved side channel flows and alcove channel connectivity to general floodplain inundation frequency and extent. Levees at one site that previously contained the 10-year flow event were removed and the floodplain is now connected during the 2-year return period event (Figures 4, 5, and 6). New culverts were installed through an existing roadway and reconnected valuable alcove and wetland habitat (Figure 7).



Figure 4: River, levee, and floodplain before the project at summer low flow



Figure 5: Floodplain inundation at a 2-year event following levee removal



Figure 6: Floodplain inundation at a 2-year event following side channel enhancement



Figure 7: Culvert connecting alcove wetland before (inset) and after

Instream habitat enhancement was achieved through placement of large woody material (LWM) and construction of engineered log jams (ELJs) along with strategic channel reshaping to promote the natural pool-riffle development process and spawning gravel distribution. ELJs were placed at the side channel entrances to regulate high flows while maintaining low-flow connectivity. ELJs and smaller LWM placements were also used along the length of the side channels to provide cover and hydraulic complexity and encourage natural channel variability over time (Figures 8 and 9). Many of the ELJ structures have shown dramatic increases in juvenile and adult salmon use compared to pre-project conditions (Figures 10 and 11).



Figure 8. Log jams and large wood in a side channel (looking upstream).



Figure 9. Log jams in a side channel (looking downstream).

Results

Collectively, the sites enhanced habitat along several thousand feet of main and side channels, removed nearly 1,000 feet of levee, placed thousands of LWM pieces, reconnected off-channel wetlands, and planted thousands of riparian trees and shrubs. The following table provides additional detail on project statistics.

Table 1. Project Statistics

Main channel enhancement	3,500 feet (1,070 m)
Side channel enhancement	3,000 feet (914 m)
Levee removal	900 feet (274 m)
Large woody material placed	2,000 pieces
Engineered log jams constructed	30 structures between 8 types
Off-channel wetlands connected	10 acres (4 ha)
Riparian trees and shrubs planted	3,000



Figure 10. Abundance of salmonids observed in class engineered logjams built as habitat structures of different sizes and nearby control areas without structures.

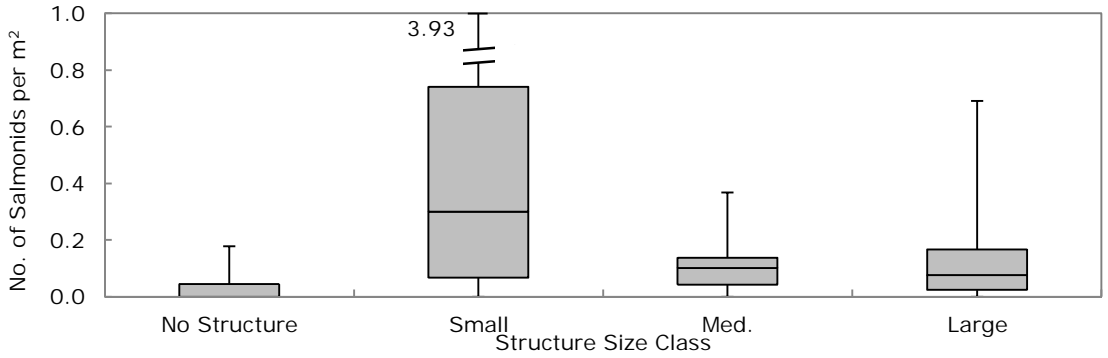

Figure 11. Number of salmonids observed per square meter of habitat in engineered logjams of different sizes and nearby control areas without structures.

Torrent restorations in the flysch mid-mountain environment: The case study of the Kněhyně Torrent, Czech Republic

Galia T, Škarpich V & Hradecký J

TOMÁŠ GALIA, VÁCLAV ŠKARPICH & J. HRADECKÝ

*Department of Physical Geography and Geoecology, University of Ostrava,
Chittussiho 10, Ostrava 710 00, Czech Republic*

The occurrence of channel-reach morphologies (e.g., bedrock channels, step-pools, anabranching channels) in mountainous landscape is driven by several internal and external time- and space-variable factors. Especially, the identification of the sediment supply potential related to transport capacity is crucial for later stream management in torrential mountain channels. The contribution deals with theoretical aspects of stream restorations of this part of fluvial net with emphasis on the flysch Western Carpathians on the example of restored anabranching channel-reach of the Kněhyně Torrent. This channel-reach was partly renaturalized by the 100y flood event in 1997, when the single riprap-regulated channel was transformed into anabranching pattern with relatively large gravel deposits. Stabilization elements were added into the channel to preserve that morphology during the restoration project realized in 2003-2004. The field geomorphological mapping shows, that longitudinal disconnectivity in the form of check-dams exists in the stream longitudinal course and recent potential sediment sources are limited at the watershed scale. These facts make difficult the sustainable preservation of the transport-limited conditions in the Kněhyně. We suppose, that the original anabranching pattern noticed by the 2nd Military Survey (the first half of the 19th century) was resulted from the higher sediment supply caused by different land-use of mountain region and the important role was played by the sediment delivery driven by debris flows under suitable climatic conditions during the Little Ice Age. The role of potential sediment supply estimations, bedload transport modelling and dendrogeomorphological approach is discussed in order to better assess relationship between the sediment supply, transport capacity and resulted channel-reach morphology.

Introduction to restorations of torrential streams

The occurrence of channel-reach morphologies with specific ratio of transport capacity to sediment supply (e.g., bedrock channels, cascades, step-pools, pool-riffles, anabranching channel pattern) in mountainous landscape is driven by several internal and external time-variable and space-variable factors. The identification of sediment supply potential and transport capacity during flood events is crucial for later management of torrential streams. Flash floods, debris-flows, intensive bedload transport and accelerated erosion belong to natural hazards related to mountain channels. Torrents are traditionally subjected to stabilization of their channel beds by staircase-like sequences of cemented, boulder or wooden grade-control structures even a few meters high in order to achieve equilibrium bed gradient preventing from erosion and also decelerating bedload transport processes. Nevertheless, such approach may lead to incision of channels by the "hungry water effect" in downstream parts and significant decrease in biota migration. Restorations of mountain streams in past twenty years are related especially to stabilizations of channel beds by more natural elements, namely by rapid hydraulic structures or large boulders which mimic step-pool morphology (e.g., Lenzi 2002, Chin et al. 2008). However, one should note that occurrence of step-pool morphology is

connected rather to limited sediment supply conditions (e.g., Recking et al. 2012, Galia and Hradecký 2014).

Our contribution presents the restoration of a torrential channel-reach under past (and potentially recent) high sediment supply conditions, where different restoration technologies have been used. Some approaches for estimation of sediment supply conditions and sustainability of the restorations in mountain channels are also discussed.

The Kněhyně restoration

Local settings and history of the Kněhyně Torrent management

The midmountain area of the Moravskoslezské Beskydy Mts (situated in the eastern part of the Czech Republic) is built by the flysch nappe structure with alternations of claystone and sandstone layers with various thicknesses. Such geological predispositions together with relatively high precipitations (up to 1500 mm/year) especially caused by cyclones imply both shallow and deep slope instabilities and time-scale fluctuating sediment inputs into fluvial segment. On the other hand, delivered material is relatively fine-grained with very limited volumes of boulder fraction, which causes low channel bed roughness and proneness of local channels to acceleration of bedload transport processes and incision. Critical conditions for beginning of bedload transport (e.g., unit stream power) in local headwaters are significantly lower when compared to other mountainous landscapes (Galia and Hradecký 2012). The so-called Wallachian and Pastoral colonization caused significant deforestation of the area between 16th -19th centuries, from the end of the 19th afforestation took place. Recent forest cover is predominantly consisted by Norway spruces (*Picea abies*) and beeches (*Fagus sylvatica*) and the area is under intensive forest management.

The Kněhyně Torrent drains southern slopes of the Radhošť Mt. (1129 m a.s.l.) and the Čertův Mlýn Mt. (1203 m a.s.l.). The upstream length of the main channel from the restored channel-reach (49.4539061N, 18.2745919E, about 300 m in length) is about 4 km and the upstream watershed area is about 10.5 km². The channel gradient in restored channel-reach is 0.031 m/m and the main channel width oscillates about 6 m, recurrence intervals (R.I.) are 5.1 m³s⁻¹ and 9.6 m³s⁻¹ for one and two-year discharges, 22.8 m³s⁻¹ and 52 m³s⁻¹ for ten and hundred-year discharges respectively (Czech hydrometeorological institute). Historical maps from the half of the 19th century (2nd Austrian Military Survey) showed anabranching channel pattern in this restored river-reach, pointing on the increase in sediment supply from headwater zones by accelerated slope processes owing to the deforestation and to a certain extent, also climatic conditions during Little Ice Age could play some role. However, the torrent was channelized by rip-rap structures almost up to headwater segments during the first half of the 20th century and several grade-control structures were built within the stream longitudinal profile. The large flood event in June of 1997 (up to 100 R.I. discharge) destroyed the channelization works in the studied reach and the channel was re-naturalized into the anabranching stream pattern. Nevertheless, local policy attempted to reparation of rip-rap structures and rapid incision of the channel-reach began.

Post-flood restoration

The restoration project was prepared and realized in the years 2003-2004 in order to stop the accelerated channel incision and to create a pilot restored channel-reach in

rather unusual high sediment supply conditions. The project included sinuous channel planform with banks stabilized by stumps and boulders and the channel bed was vertically stabilized by submerged logs. A secondary channel was projected, which should be flooded by annually high flow events (e.g., after rapid snow melting or summer storms). The alluvium between the main channel and the secondary channel was stabilized by willow trees (*Salix sp.*) in order to decrease downstream sediment supply preventing from potential damages by intensive bedload transport in the urban area of village. An important part was the construction of the boulder chute immediately downstream the restored reach. In fact, this element represents erosional base level protecting the restored reach from the backward incision (Fig. 1).

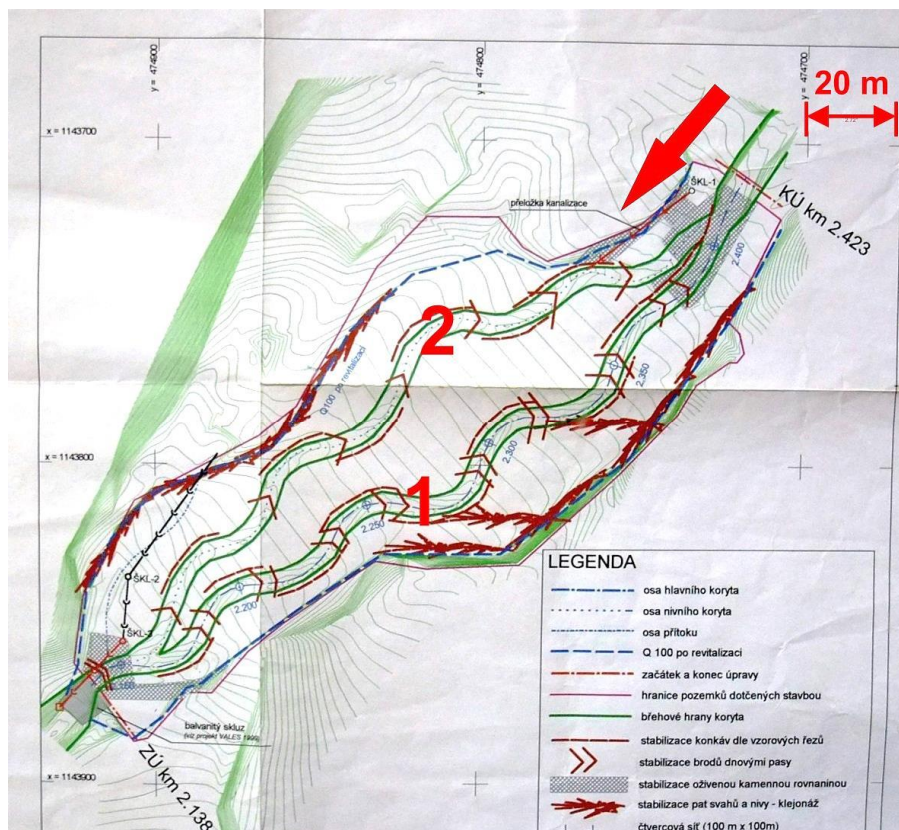

Figure 1. Map of the revitalized channel-reach with indicated stabilization elements (brown symbols). 1 – main channel, 2 – secondary channel, red arrow – flow direction.

Unfortunately, no regular monitoring has been done in the restored channel-reach since its construction although it was recommended by the project. Especially after the larger flood event in May of 2010 (up to 15-20 R.I. discharge), the incision tendency has been observed in some parts of the restored reach and the secondary channel has been disconnected from the regular flooding (see Fig. 2).



Figure 2. Downstream part of the restored reach with exposed log as a stabilization element (the log was originally at the channel bed level).

THE RESTORATION SUSTAINABILITY

Present watershed conditions

The main task is, which channel pattern of the restored river-reach corresponds to the recent conditions in the Kněhyně watershed. A hundred years before, the anabranching channel pattern existed there similarly to some other locations in the Moravskoslezské Beskydy Mts and their piedmountain area. One should note smaller forest cover and a bit different climatic conditions in the 19th century (the end of the Little Ice Age) leading to potentially increased sediment supply from hillslopes. Channelization works during 20th century prevented lateral migration of the stream and decreased sediment supply from banks. Geomorphological field mapping of the Kněhyně watershed showed that potential large sediment inputs (large landslides, debris-flow prone channels) are often stabilized and the bedrock outcrops occur in channel bed in the large part of headwater zones reflecting recently limited sediment supply. Presence of check-dams decreases bedload transport rates between headwater zones and restored channel-reach during ordinary flood events. These facts probably cause incision in some parts of the restored reach, although large natural dynamics of torrential streams with alternation of erosional and depositional processes should be reflected.

Methods of the restoration sustainability assessment

The existence of depositional restored channel-reach is conditioned by high sediment-supply and stabilization of the local channel gradient. The second condition is fulfilled by the boulder chute immediately downstream the restored channel-reach and some stabilization elements (logs) in the channel. But how much sediment should be delivered into the restored reach to achieve depositional conditions? At least a rough sediment budget should be established for the upstream part of the watershed, when a complex approach is needed (Gertsch et al. 2012). The estimation of presented volumes of gravel

material in the restored reach can be done by some geophysical sounding methods, e.g. by electrical resistivity tomography (ERT). Unfortunately, direct bedload transport measurements are very time-consuming and expensive. Thus, some 1D hydraulic and sediment-transport model (e.g. TomSED or HEC-RAS) is able to evaluate transport capacity of the upstream part of the longitudinal profile with and without presence of grade-control structures. Rough calibration of the model can be done against observed erosion and deposition after some documented flood event. Such approach has been recently applied in order to estimation of sediment budget in the nearby Velký Škaredý Brook, located on the north slopes of the Radhošť Mt. (Šilhán and Galia 2015). Geomorphological mapping with accented fluvial processes and hillslope-channel coupling gives evidence about individual sediment inputs and contemporary storage elements in the stream longitudinal profile. Individual inputs (e.g., bank failures) should be measured in order to obtain their sediment delivery potential. Repeated geodetic measurements (LiDAR, total stations) or erosion pins provide information about erosion rates, but these methods are again very time-consuming and dependent on the floods occurrence. But dendrogeomorphic methods focused on exposed roots represents good estimations of delivered material by past high flow events from individual inputs (Corona et al. 2011; Šilhán and Galia 2015).

References

- Chin, A., Anderson, S., Collison, A., Ellis-Sugai, B.J., Haltiner, J.P., Hogervorst, J.B., Kondolf, G.M., O'Hirok, L.S., Purcell, A.H., Riley, A.L., Wohl, E. (2008). Linking theory and practice for restoration of step-pool streams. *Environmental Management* 43: 645-661.
- Corona, Ch., Lopez Saez, J., Rovéra, G., Stoffel, M., Astrade, L., Berger, F. (2011). High resolution, quantitative reconstruction of erosion rates based on anatomical changes in exposed roots at Draix, Alpes de Haute-Provence—critical review of existing approaches and independent quality control of results. *Geomorphology* 125: 433–444.
- Galia, T., Hradecký, J. (2012). Critical conditions for beginning of coarse sediment transport in torrents of Moravskoslezské Beskydy Mts. (Western Carpathians). *Carpathian journal of Earth and environmental sciences* 7: 5-14.
- Galia, T., Hradecký, J. (2014). Channel-reach morphology controls of headwater streams based in flysch geologic structures: An example from the Outer Western Carpathians, Czech Republic. *Geomorphology* 216: 1–12.
- Gertsch, E., Lehmann, C., Spreafico, M. (2012). Methods for the estimation of erosion, sediment transport and deposition in steep mountain catchments. A contribution to the International Sediment Initiative of UNESCO/International Hydrological Programme. 69 p. Lelystad, CHR.
- Lenzi, M. A. (2002). Stream bed stabilization using boulder check dams that mimic step-pool morphology features in northern Italy. *Geomorphology* 45: 243–260.
- Recking, A., Leduc, P., Liébault, F., Church, M. (2012). A field investigation of the influence of sediment supply on step-pool morphology and stability. *Geomorphology* 139–140: 53–66.
- Šilhán, K., Galia, T. (2015). Sediment (un)balance budget in a high-gradient stream on flysch bedrock: A case study using dendrogeomorphic methods and bedload transport simulation. *Catena* 124: 18–27.

Towards a MORE comprehensive assessment of river ecological conditions: application of a new dragonfly-based index in northern Italy

Golfieri B et al.

BRUNO GOLFIERI¹, NICOLA SURIAN¹, S. HARDERSEN.², B. MAIOLINI³

¹ *Department of Geosciences, University of Padova, Via G. Gradenigo 6, Padova, 35131, Italy.*

² *Corpo Forestale dello Stato, Centro Nazionale per lo Studio e la Conservazione della Biodiversità Forestale "Bosco Fontana", Strada Mantova 29, Marmirolo (MN), 46045, Italy.*

³ *E. Mach Foundation, Research and Innovation Centre, Via E. Mach 1, San Michele all'Adige (TN), 38100, Italy.*

Abstract

In this study we analysed the relationships between the Morphological Quality Index (MQI) and three biotic indices that are based on different riverine organism groups (dragonflies, diatoms and benthic macroinvertebrates). The study was carried out in fifteen river reaches in the alluvial plains of northern Italy. Benthic macroinvertebrates and diatoms are good indicators of water quality, but seem not to be sensitive to hydromorphological degradation, while dragonflies provide information about the ecological integrity and habitat heterogeneity of both the aquatic breeding sites and the surrounding terrestrial areas, due to their amphibious life cycle and their well known ecological requirements. Starting from a dragonfly-based assessment system proposed in Austria, we developed a multimetric index, the Odonate River Index (ORI), which assesses the conditions of the whole river corridor, because also secondary channels and ponds in the floodplain are sampled. MQI and ORI turned out to be highly correlated, while no significant relationships were found between MQI and the indices that are based on diatoms (i.e. ICMi) and benthic macroinvertebrates (i.e. STAR_ICMi). These results suggest that dragonflies are good indicators of the ecological integrity of river corridors at reach scale, also reflecting morphological quality, and that the ORI provides information on the ecological condition of rivers not covered by the other bioindicators.

Introduction

The assessment of the ecological conditions of rivers is crucial for their appropriate management and for planning restoration projects. The European Water Framework Directive 2000/60/EC (WFD) introduced the assessment of hydromorphology, in addition to the evaluation of biological and physical-chemical elements, to define the ecological status of rivers. As far as the biological aspects are concerned, the WFD suggests the use of aquatic organisms (i.e. benthic macroinvertebrates, benthic diatoms, aquatic macrophytes and fish) as bioindicators to evaluate stream ecological conditions. These organisms are widely considered as good indicators of water pollution and eutrophication (Hering et al., 2006), however recent studies demonstrated that their use presents two main limitations: (i) they do not seem to be sensitive to hydromorphological degradation and to interventions of river restoration (Jähnig et al., 2010; Dahm et al., 2013; Haase et al., 2013; Feld et al., 2014) and (ii) their standard application is limited to flowing channels.

Alternative methods were developed to assess the ecological condition of the river corridor and an important example is the evaluation system proposed by Chovanec et al. (2001). This method is based on dragonfly surveys and on the calculation of the Odonate Habitat Index (OHI). Dragonflies occupy an important role in the assessment of aquatic ecosystems due to their amphibious life cycle and because of their well-known ecological requirements. They provide information about the ecological integrity (i.e. vegetation structure and hydrological connectivity) and habitat heterogeneity of both the aquatic breeding sites and the surrounding terrestrial areas (Simaika and Samways, 2012).

The aim of this work is to analyse the relationships between hydromorphological and ecological conditions of a set of river reaches in northern Italy using specific indices: the Morphological Quality Index (MQI; Rinaldi et al., 2013) and three biotic indices, two of them based on bioindicators proposed by the WFD, STAR_ICMi for benthic macroinvertebrates (Buffagni et al., 2005) and ICMi for diatoms (Mancini and Sollazzo, 2009), and the new dragonfly-based Odonate River Index (ORI; Golfieri et al., under review).

Materials and methods

The study was carried out in seven Italian Alpine rivers: three of them (i.e. Chiese, Sesia and Stura di Demonte rivers) drain from the central-western Alps, while the others (i.e. Adige, Brenta, Meduna and Tagliamento rivers) drain from the eastern portion of the Alps (Table 1).

Table 1. Physiographic, hydrological and morphological characteristics of the study rivers. Channel morphology: B: braided; W: wandering; Si: sinuous; M: meandering. Dominant substrate: G: gravel; S: sand.

River	Length (km)	Catchment area (km ²)	Rainfall (mm/yr)	Mean discharge (m ³ /s)	Number of study reaches	Channel morphology of study reaches	Dominant substrate of study reaches
Tagliamento	172	2580	2150	109	2	B / M	G / S
Meduna	85	1044	1850	35	2	B / Si	G / G
Brenta	160	1787	1386	71	3	B / Si / M	G / S / S
Adige	410	11954	933	220	2	M / Si	G / S
Chiese	147	1523	1244	36	2	M / M	G / S
Sesia	138	3075	1234	76	2	B / M	G / S
Stura Demonte	111	1480	1079	47	2	B / W	G / G

These rivers were chosen because they present different morphological and ecological conditions and degree of human impact: the Tagliamento River and the Stura di Demonte River exhibit a high level of naturalness, while the Adige and Chiese rivers present degraded conditions due to widespread interventions of channelization and the alteration of the hydrological regime. The Brenta, Meduna and Sesia rivers are characterized by a moderate degree of human impact. A total of 15 study reaches was selected: 3 reaches along the Brenta river and 2 reaches along each other study river. All study reaches are located in alluvial plains. In most cases, the study reaches belonging to the same river were located in different physiographic contexts (i.e. the high and low alluvial plain).

Since the chemical status of the water bodies investigated was classified as high or good, and no other pressures (e.g. hydropeaking or significant water abstraction) were identified, it can reasonably be assumed that hydromorphological degradation is the main pressure acting on the study reaches.

For each study reach we calculated the values of the MQI and of the ORI. The Morphological Quality Index (MQI) mainly focuses at the reach scale, evaluating the conditions of the whole river corridor (i.e. active channel and adjacent floodplain/recent terraces), but considers also elements at catchment (e.g. sediment flux) and site (e.g. substrate condition) scale. It is composed of 28 indicators that are grouped into three categories: morphological functionality, artificial elements and channel adjustments. Analyses based on remote-sensing and/or field surveys are required to assess to quality classes of the different indicators.

The Odonate River Index (ORI) (Golfieri et al., under review) is based on the Odonate Habitat Index (OHI) (Chovanec and Waringer, 2001) but contains important improvements (i.e. standardized sampling strategy and the attribution to the classes of the ecological status in a quantitative manner). The ORI is applied at reach scale and requires the surveys of 4 sampling sites, that should represent the diversity of aquatic habitats present in the river corridor, along a gradient of connectivity from the main channel to disconnected ponds in the floodplain. Only Odonata species validated as breeding locally are considered for calculating the ORI and the class of ecological status is assigned on the basis of five metrics. The metrics considered are: (i) total number of species, (ii) number of sensitive species, (iii) total number of families, (iv) mean value of the OHI in the reach, (v) range of the OHI in the reach. The OHI is calculated for each sampling site on the basis of habitat preferences, sensitivity and abundance of the species validated as breeding, and describes the degree of connectivity of the site to the main channel. The mean OHI value of the reach indicates the character of the odonate community from lentic to lotic, while the OHI range describes the diversity of habitats in which dragonflies breed inside the reach: the greater its value, the greater is the heterogeneity of habitats and the connectivity between channel and floodplain. Sensitive species are those which present a high value of the species-specific parameter of sensitivity (i.e. indication weight): these values, listed by Chovanec and Waringer (2001), were modified for the geographical context of northern Italy. ORI values range from 0, that represents totally altered conditions, to 1, which expresses undisturbed conditions of the river corridor, and are assigned to one of the five classes of ecological status, in line with the WFD requirements. Odonate surveys were conducted between May and October of the years 2011 (Adige, Brenta and Tagliamento rivers), 2012 (Chiese, Sesia and Stura di Demonte rivers) and 2014 (Meduna River). Each study reach was sampled four times and all sampling sites within the river reach were always sampled in one day. Dragonfly surveys consisted in timed observation of adults (i.e. 30 minutes per sampling site) and timed collection of exuviae (i.e. 30 minutes per sampling site).

The values of the indices STAR_ICMi and ICMi were provided by the regional environmental agencies (ARPA). We considered only values of the above-mentioned indices measured in sampling stations that were either inside the study reaches or that were inside 5 kilometres from their limits. In the latter case, the values of the biotic

indices were taken into account only if no major physical or anthropic discontinuities are present (e.g. changes in channel morphology, relevant confluences, presence of derivations, dams or weirs) between the sampling site and the study reach. For this reason only eleven and nine values of STAR_ICMi and ICMi could respectively be attributed to the study reaches.

Nonparametric Spearman's r correlation coefficient was used to evaluate the relationships between the MQI and the three biotic indices (i.e. ORI, STAR_ICMi and ICMi).

Results

The MQI values range between 0.46 (Verona reach – Adige River), that corresponds to class poor, and 0.88 (Ronchi reach – Stura di Demonte River), corresponding to class high. The majority of the study reaches, 10 out of 15, present moderate morphological conditions (i.e., $0.50 \leq \text{MQI} < 0.70$), while the remaining three reaches show good morphological conditions (i.e., $0.70 \leq \text{MQI} < 0.85$). The morphological alteration that were frequently recorded were the reduction of floodplain, the presence of bank protections and levees, cutting of vegetation in the fluvial corridor and alteration of sediment transport in the upstream catchment.

The ORI values range between 0 and 1, covering all the quality classes with the exception of class "poor" (i.e., $0.2 \leq \text{ORI} < 0.4$). Six study reaches present high (i.e., $0.8 \leq \text{ORI} \leq 1$) or good (i.e., $0.6 \leq \text{ORI} < 0.8$) ecological conditions on the basis of dragonfly surveys. The well-structured odonate communities that were observed in these study reaches are linked to the presence of river corridors that present an intact (or only slightly disturbed) gradient of lateral continuity, from the main channel to disconnected ponds in the floodplain. In these reaches artificial structures (e.g. bank protections and levees) are generally absent and direct human activities and pressures (i.e. agriculture, sediment mining, hydroelectric use) are limited. Sampling sites, especially lentic ones, are usually characterized by the presence of aquatic vegetation, while surrounding areas present a mosaic of woodlands and open areas.

Seven study reaches show a moderate ecological status (i.e., $0.4 \leq \text{ORI} < 0.6$), while 2 reaches (Verona reach – Adige River and Montichiari reach – Chiese River) were attributed to class "bad" (i.e., $0 \leq \text{ORI} < 0.2$). The reaches with bad ecological conditions present an extremely simplified breeding community composed only of a small number of rheophilous species, (i.e. *Calopteryx splendens*, *Onychogomphus forcipatus* and *Platycnemis pennipes*) or by the complete absence of breeding dragonflies. The scarce presence of odonates is due to the lack of lateral habitats (i.e. secondary channels and ponds) and due to notable morphological alterations of the main channel, which is characterized by the diffuse presence of bank protections and by levees in direct contact with river banks. The homogeneous cross-section leads to a reduction of the potential microhabitats suitable for reproduction of dragonflies.

MQI and ORI values show a high and significant correlation ($r=0.71$; $p\text{-value}=0.003$) (Figure 1).

On the other hand, no significant relationships were found between STAR_ICMi and MQI ($r = 0.28$; $p\text{-value}=0.41$) and between ICMi and MQI ($r = -0.20$; $p\text{-value}=0.61$) (Figure

2). It is also worth to underline that all ICMi values fall into class "high", while STAR_ICMi values range between moderate and high class.

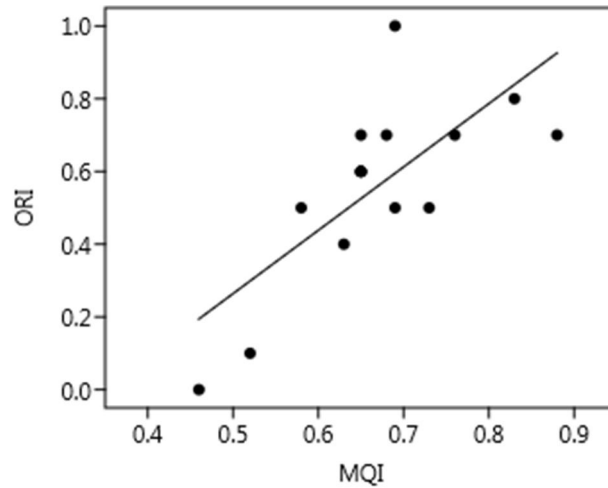

Figure 1. Relationship between ORI and MQI values.

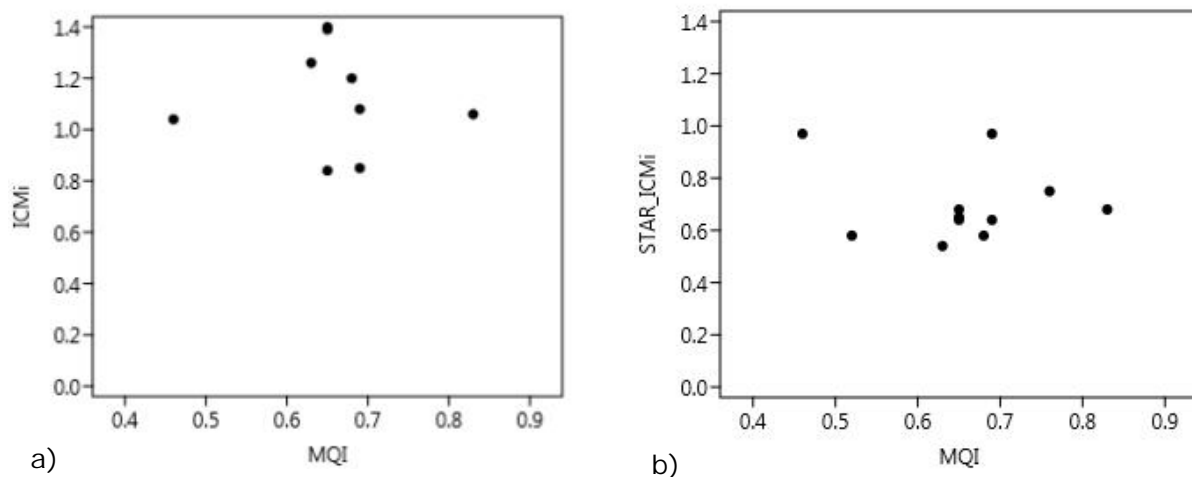

Figure 2. Relationship between a) STAR_ICMi and MQI and b) ICMi and MQI .

Discussion

MQI and ORI show a high and significant correlation, while no significant relationships were found between MQI and STAR_ICMi and between MQI and ICMi. These results should be seen as preliminary as the number of study reaches analysed is relatively low. However, if the ORI is tested successfully also in other river systems it should be considered as an approach towards a more comprehensive assessment of river ecological conditions.

It can already be said that our results are probably due to: (i) the different spatial scales at which the biotic indices work and (ii) the different sensitivity to human pressures of the bioindicators analysed. STAR_ICMi and ICMi work at site scale and sampling sites are always located along the main channel. In contrast, the ORI is a reach scale method, like

the MQI, and the sampling sites represent the different aquatic habitats that are present within the river corridor (i.e. main and secondary channel, non-flowing channel and ponds). Moreover, many studies indicate that benthic macroinvertebrates and diatoms are more sensitive to water quality than to hydromorphological degradation (Hering et al., 2006; Dahm et al., 2013). Dragonflies instead provide information about vegetation structure, hydrological connectivity and habitat heterogeneity of both the aquatic breeding sites and the surrounding terrestrial areas (Simaika and Samways, 2012). The results of the present study suggest that dragonflies are good indicators of the ecological integrity of river corridors, being sensitive to morphological degradation, and that the ORI evaluates elements not covered by other bioindicators provided by the WFD, such as benthic macroinvertebrates and diatoms. Exclusive relying on these indicators does not seem to allow a comprehensive assessment of the ecological conditions of the whole river corridor, especially where the aquatic system occupies a limited portion of the corridor, as is the case of reaches with a braided or wandering morphology.

Furthermore, the ORI seems a suitable tool for monitoring the success of restoration actions, as odonates are very sensitive to habitat improvements and rapidly colonize new sites (Simaika and Samways, 2012), while other bioindicators, as benthic macroinvertebrates, do not show significant response to such actions (Jähnig et al., 2010; Haase et al., 2013).

Acknowledgements

We would like to thank the environmental agencies (ARPA/APPA) of the Regions Piemonte, Lombardia, Veneto, Friuli Venezia Giulia and of the Autonomous Province of Trento for providing the values of STAR_ICMi and ICMi indices.

References

- Buffagni A., Erba S., Birk S., Cazzola M., Feld C., Ofenböck T., Murray-Bligh J., Furse M.T., Clarke R., Hering D., Soszka H., van de Bund W. (2005). Towards European Inter-calibration for the Water Framework Directive: Procedures and examples for different river types from the E.C. project STAR. 11th STAR deliverable. Quaderni Istituto di Ricerca sulle Acque 123, IRSA, Roma.
- Chovanec, A., Waringer, J. (2001). Ecological integrity of river-floodplain systems assessment by dragonflies surveys (Insecta: Odonata). *Regulated Rivers: Research and Management* 17: 493-507.
- Dahm, V., Hering, D., Nemitz, D., Graf, W., Schmidt-Kloiber, A., Leitner, P., Melcher, A., Feld, C.K. (2013). Effects of physico-chemistry, land use and hydromorphology on three riverine organism groups: a comparative analysis with monitoring data from Germany and Austria. *Hydrobiologia* 704: 389-415.
- Feld, C.K., de Bello, F., Dolédec, S. (2014). Biodiversity of traits and species both show weak responses to hydromorphological alteration in lowland river macroinvertebrates. *Freshwater Biology* 59: 233-248.
- Golfieri, B., Hardersen, S., Maiolini, B., Surian, N.. Odonates as indicators of the ecological integrity of the river corridor: development and application of the Odonate River Index (ORI) in northern Italy. Under review.
- Haase, P., Hering, D., Jähnig, S.C., Lorenz, A.W., Sundermann, A. (2013). The impact of hydromorphological restoration on river ecological status: a comparison of fish, benthic invertebrates, and macrophytes. *Hydrobiologia* 704: 475-488.
- Hering, D., Johnson, R.K., Kramm, S., Schmutz, S., Szoszkiewicz, K., Verdonschot, P.F.M. (2006). Assessment of European streams with diatoms, macrophytes, macroinvertebrates and fish: a comparative metric-based analysis of organism response to stress. *Freshwater Biology* 51: 1757-1785.
- Jähnig, S.C., Brabec, K., Buffagni, A., Erba, S., Lorenz, A.W., Ofenböck, T., Verdonschot, P.F.M., Hering, D. (2010). A comparative analysis of restoration measures and their effects on

- hydromorphology and benthic invertebrates in 26 central and southern European rivers. *Journal of Applied Ecology* 47: 671-680.
- Mancini, L., Sollazzo, C. (2009). Metodo per la valutazione dello stato ecologico delle acque correnti: comunità diatomiche. Rapporti Istituto Superiore di Sanità, ISTISAN, Roma.
- Rinaldi, M., Surian, N., Comiti, F., Bussetini, M. (2013). A method for the assessment and analysis of the hydromorphological condition of Italian streams: The Morphological Quality Index (MQI). *Geomorphology* 180-181: 96-108.
- Simaika, J.P., Samways, M.J. (2012). Using dragonflies to monitor and prioritize lotic systems: a South African perspective. *Organisms Diversity and Evolution* 12: 251-259.

Applying process-based hydromorphological assessment to the identification of fine sediment pressures and impacts in a lowland agricultural catchment

Grabowski R C & Gurnell A M

ROBERT C. GRABOWSKI¹ & ANGELA M. GURNELL²

¹*Cranfield Water Science Institute, Cranfield University, Cranfield, Bedfordshire, UK MK40 0AP.*

²*School of Geography, Queen Mary University of London, London, E1 4NS*

Fine sediment is a widespread pressure affecting rivers across Europe, particularly those in agricultural or urban settings. Changes to the quantity and quality of fine sediment entering rivers means that what was once a purely natural component of river systems now impacts significantly the ecology and hydromorphology of waterbodies. Methods to identify sediment sources, pathways and impacts are needed to develop a fuller understanding of sediment transport processes in order to develop sustainable management solutions. In this study, the hierarchical hydromorphological assessment framework developed in the REFORM project was applied to a lowland gravel bed river affected by excess fine sediment. The framework was used to uncover the possible sources and timing of fine sediment delivery to the river channel and its impact on channel geomorphology over the last 100 years. A catchment-scale analysis of land cover and agricultural land use identifies intensive cereal cultivation and livestock production in the second half of the 20th century as the likely sources of excess fine sediment. It also suggests that the absence of significant riparian vegetation cover facilitated the delivery of fine sediment to the river network. A reach-scale analysis of channel planform using historical maps notes decreases in channel widths and increases in reach sinuosity over this time period. Field observations suggest that riparian and aquatic vegetation are central to this progressive adjustment through the trapping and stabilisation of fine sediment in bars, benches and islands. The study demonstrates how a process-based framework can be used to diagnose fine sediment pressures and identify management solutions.

Introduction

Fine sediment is an essential component of the ecology and geomorphology of river systems. It is the fundamental building block of landforms that provide the physical structure for ecological habitats, and is central to the transport and storage of organic material and nutrients in rivers and floodplains. Humans, though, have altered the quality and quantity of sediment in rivers, which has turned fine sediment into a management problem (Owens et al. 2005). Excess fine sediment is being delivered to rivers, particularly lowland rivers in urban and agricultural settings, and this sediment is often contaminated with bacteria, heavy metals, nutrients and other pollutants (Owens et al. 2005). Once in the channel, the excess fine sediment impacts the geomorphology and ecology of the system; infiltrating into the sediment bed, forming surficial layers of fine sediment, impairing water quality and harming ecological communities (Acornley & Sear 1999; Gurnell et al. 2006; Heppell et al. 2009). Whilst it is clear that fine sediment must be managed, it is difficult and often prohibitively expensive to undertake once the

sediment is already in the river channel. Reducing sediment production at source and decreasing the connectivity between source areas and the river network are believed to be the most sustainable solutions (Apitz 2012). Although fine sediment production and transport to river systems has been well studied, the identification of sources and the mapping of transport pathways is still limited by data availability and methods to resolve its intrinsic spatial and temporal variability (Sear et al. 2010). Therefore, an approach is needed to identify sediment sources, the timing of sediment production, and its geomorphological consequences within river channels, which is applicable at the catchment scale.

This paper demonstrates how freely-available datasets can be examined within a hierarchical framework for hydromorphological assessment (Gurnell et al., 2015) to investigate fine sediment pressures and impacts. The study focuses on a lowland river in an agricultural setting with a reported excess fine sediment problem. The hydromorphological framework is used to fill gaps in the existing understanding of the problem by identifying changes in land cover over time that could impact sediment production and the extent of riparian vegetation that could intercept delivery of fine sediment to the channel, and by quantifying changes in channel dimensions and planform over time to assess the geomorphological impacts of excess fine sediment.

Methods

The framework (Gurnell et al. 2015) was applied to the River Frome (Dorset, England), a lowland gravel bed river protected for its species-rich aquatic plant communities and important river and floodplain habitats. Lowland chalk rivers are sensitive to elevated fine sediment loads because their ecological communities are dependent on clean gravel beds and low turbidity levels, and their high width:depth ratio channels and baseflow-dominated flows produce moderate flows with limited capacity to erode sediment once it deposits on the bed. Increased fine sediment deposition within the River Frome has been noted over recent decades (Walling & Amos 1999; Collins & Walling 2007), but little direct evidence exists to assess temporal trends in sediment loads or to identify sources, and no geomorphological surveys exist to assess changes in channel dimensions. Therefore, agricultural records (spring agricultural census, Defra) and historical land cover maps (First Land Utilisation Survey, 1936/1945; UK Countryside Survey, 1990, 2000 and 2007) were used to investigate changes in land cover over time which would influence sediment production and delivery to the channel, and historical Ordnance Survey maps (1889, 1960/0973, 2013) were used to detect and quantify changes in channel dimensions.

Results

Changes in sediment production/delivery over time

Land cover in the River Frome catchment has changed little over the last 70 years. The catchment has historically been and remains dominated by agriculture. Agricultural surfaces have consistently covered almost 90% of the catchment area. Agricultural land use, though, has changed over this period. County-level agricultural census records document a decrease in permanent grassland and rough pasture in Dorset over the latter half of the 20th century, which was mirrored by an increase in the area of arable land (Fig 1a). The crops cultivated on the arable land also varied over time, and have shifted to a predominance of cereals (wheat and barley) (Fig 1b). The change to cereal production

coincided with a period of increases in crop yields in England and Wales (Fig 1d). Livestock numbers also changed substantially over time in Dorset, shifting from sheep to cattle and pig and increasing in numbers (Figure 1c).

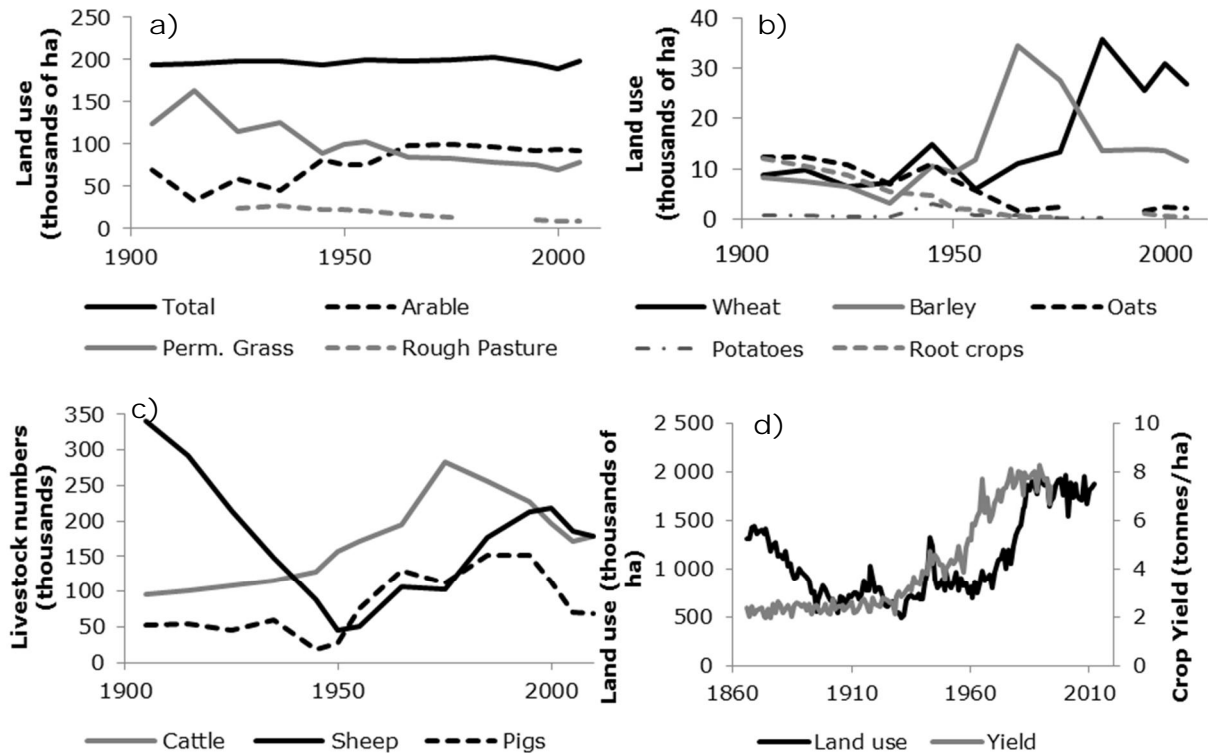

Figure 1. Agricultural land use for the county of Dorset over the last century by (a) area of land under different land use types, (b) area of arable land under different crop types, (c) livestock numbers for cattle, sheep and pigs. (d) Area of arable land cultivated and yields for wheat for England and Wales.

Furthermore, riparian vegetation cover is low over most of the main stem of the River Frome, and river margins have little riparian vegetation to act as a buffer to intercept runoff and sediment transported from agricultural land. The majority of the main stem has riparian vegetation covering less than or equal to 10% of the floodplain area, apart from the headwaters which have greater than 30% vegetation coverage.

Channel adjustment over time

Channel overlays from historical maps show that most reaches experienced a distinct and continuous reduction in channel area since 1889 (Fig 2a,b). With the exception of several reaches that experienced large (apparently artificial) cut-offs, reach length and thus reach sinuosity increased over time (Fig 2c,d). An increase in sinuosity was especially apparent in the second half of the 20th century (Fig 2d). As the number of channels was constant over time and channel lengths were stable or increasing, the decrease in channel area is caused by a reduction in average channel widths. While no consistent change in width was detected between 1889 and 1960/75 (Fig 2e), channel narrowing was clearly evident over the last 40-50 years (Fig 2f). Out of the 17 reaches, 12

narrowed over this period, accounting for 69% of the total length of the main stem of the river. Although width reductions are small, on the order of 1 m or less, these translate to a 5-15% reduction in channel width.

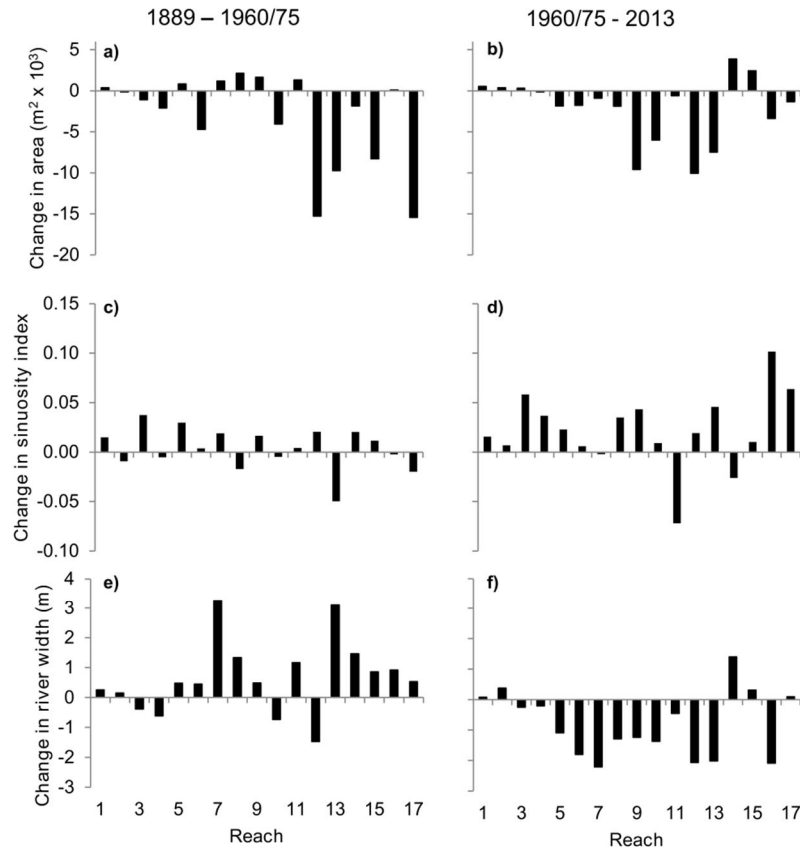

Figure 2. Changes in channel (a,b) area, (c,d) length and (e,f) width for the River Frome by reach for the periods (a,c,e) 1889-1960/75 and (b,d,f) 1960/75-2013.

Conclusions

In this study, the hierarchical framework for hydromorphological assessment developed by the REFORM project was applied to a lowland river flowing through an agricultural catchment with a recognised fine sediment problem. The study demonstrates how a process-based framework can be used to develop a fuller picture of the problem by identifying the source and timing of sediment production and delivery to the channel network, and the resulting impacts observed at the reach scale.

This study found substantial shifts in agricultural land use practices starting in the middle of the 20th century which likely resulted in increased sediment production. Intensive cultivation of arable crops, particularly autumn-sown cereals, is linked to increased soil erosion (Chambers et al. 2000). The high numbers of livestock and the shift to cattle and pig are also tied to increased sediment production and delivery to river channels (Trimble 1994; Evans 2004). Additionally, the relative lack of a zone of riparian vegetation bordering the river channel means that connectivity between agricultural areas and the river network is high along the majority of the length of the main Frome.

The temporal analysis of channel position revealed that both channel area and width decreased along the majority of the River Frome over the last 40-50 years (Fig. 2). The channel narrowed by 5-15% along 69% of its length over this time period. This is in contrast to the earlier time period (1889-1960/75), when there was no consistent trend in channel area or width changes. Whilst the coarse temporal resolution of the analysis does not allow for precise estimation of the timing of narrowing, the results clearly indicate a correlation between channel narrowing and the adoption of agricultural practices that are known to increase soil loss in the second half of the 20th century.

Evidence from the field suggests that the mechanism for channel narrowing and increasing sinuosity is aquatic plant-mediated. Fine sediment is trapped and stabilised by marginal aquatic plants (Gurnell et al. 2006). Aggradation along the margins results in the development of submerged shelves and emergent berms of vegetated fine sediment (Gurnell et al., 2013), which, as they are progressively colonised by other plant species, evolve into benches and extensions of the bank profile (Gurnell 2014). Consequently, a low energy, lowland system can adjust in response to high fine sediment delivery from agricultural sources through natural ecological-geomorphological interactions.

References

- Acornley RM, Sear DA (1999) Sediment transport and siltation of brown trout (*Salmo trutta* L.) spawning gravels in chalk streams. *Hydrological Processes* 13, 447-458.
- Apitz SE (2012) Conceptualizing the role of sediment in sustaining ecosystem services: Sediment-ecosystem regional assessment (SEcoRA). *Science of The Total Environment* 415, 9-30.
- Chambers BJ, Garwood TWD, Unwin RJ (2000) Controlling soil water erosion and phosphorus losses from arable land in England and Wales. *Journal of Environmental Quality* 29, 145-150.
- Collins AL, Walling DE (2007) Fine-grained bed sediment storage within the main channel systems of the Frome and Piddle catchments, Dorset, UK. *Hydrological Processes* 21, 1448-1459.
- Evans R (2004) Outdoor pigs and flooding: an English case study. *Soil Use and Management* 20: 178-181. doi:10.1079/sum2004248
- Gurnell AM, van Oosterhout MP, de Vlioger B, Goodson JM (2006) Reach-scale interactions between aquatic plants and physical habitat: River Frome, Dorset River. *Research and Applications* 22: 667-680
- Gurnell AM, O'Hare MT, O'Hare JM, Scarlett P, Liffen TMR (2013) The geomorphological context and impact of the linear emergent macrophyte, *Sparganium erectum* L.: a statistical analysis of observations from British rivers. *Earth Surface Processes and Landforms* 38 1869-1880
- Gurnell AM (2014) Plants as river system engineers. *Earth Surface Processes and Landforms* 39: 4-25
- Gurnell AM, Rinaldi M, Belletti B et al. (2015) A multiscale framework for developing understanding of river behaviour to support river management. *Aquatic Sciences In Review*.
- Heppell CM, Wharton G, Cotton JAC et al. (2009) Sediment storage in the shallow hyporheic of lowland vegetated river reaches. *Hydrological Processes* 23, 2239-2251.
- Owens PN, Batalla RJ, Collins AJ et al. (2005) Fine-grained sediment in river systems: Environmental significance and management issues. *River Research and Applications* 21, 693-717.
- Sear DA, Newson MD, Thorne CR (2010) *Guidebook of applied fluvial geomorphology*. Thomas Telford, London
- Trimble SW (1994) Erosional effects of cattle on streambanks in Tennessee, USA. *Earth Surface Processes and Landforms* 19: 451-464. doi: 10.1002/esp.3290190506
- Walling DE, Amos CM (1999) Source, storage and mobilisation of fine sediment in a chalk stream system. *Hydrological Processes* 13, 323-340.

The Hydromorphological Evaluation Tool

Habersack H & Klösch M

HELMUT HABERSACK & MARIO KLÖSCH

Christian Doppler Laboratory for advanced methods in river monitoring, modelling and engineering, University of Natural Resources and Life Sciences, Department of Water – Atmosphere – Environment, Institute of Water Management, Hydrology and Hydraulic Engineering, Muthgasse 107, 1190 Vienna, Austria

mario.kloesch@boku.ac.at

River engineering structures such as bank protection or bed sills act as constraints on river morphology and limit morphodynamic processes. Accordingly, the deviations of a river's morphology from a natural reference condition were attributed to the degree of artificiality in the observed river section and river restoration works mainly aimed at reducing artificial constraints within the river reach. Less attention was drawn to alterations of the sediment continuum between sediment production in the river's catchment and downstream river reaches. However, especially in gravel bed rivers, the sediment supply from upstream is strongly reflected by morphodynamics such as bar formation or reworking of the river bed. Any alteration of the quantity of sediment supply (i.e. sediment discharge) or sediment quality (e.g. grain size) may affect the morphological appearance of a reach and determine its deviation from an undisturbed condition.

The Hydromorphological Evaluation Tool (HYMET) accounts for sediment supply and sediment transfer as preconditions for sustainable morphodynamics in river reaches. At the reach scale, artificiality and the sediment budget are assessed. In contrast to existing evaluation methods for assessing hydromorphological state, no reference condition is needed for determining hydro-morphological alterations. Here, with re-established sediment supply and reduced artificiality, a river reach is expected to develop the morphodynamics that approaches a morphodynamically sustainable condition.

Application to the Drau River showed that the alteration of sediment supply strongly affects the evaluation result of a restored reach, indicating remaining potential for re-establishment of morphodynamics through catchment-wide restoration plans. In this paper the HYMET is focusing on sediment regime and morphodynamics. But the basic approach can also be extended to all hydromorphological parameters.

INTRODUCTION

The European Water Framework Directive (European Commission, 2000) prescribes an evaluation of the ecological state along all European rivers, which includes the assessment of the hydro-morphological condition. Within the existing assessment methods two issues are to be discussed:

The hydromorphology of the evaluated reach is assessed by comparing it to that of a reference condition. Most often, a historic state found on maps or aerial images is used

to define a pristine, undisturbed condition. However, boundary conditions may have changed which cannot be returned to their historic state (e.g. due to climate change, landuse). Hence, the defined reference condition may not correspond to an undisturbed state at present boundary conditions, and may therefore be misleading.

The state of sediment supply from upstream finds no or little consideration. However, the sediment regime defines the morphology of alluvial rivers as well as the presence and rate of morphodynamics.

Aiming to overcome these limitations we introduce a method, which evaluates the morphodynamics by assessing the sediment regime as their fundamental basis. Instead of following a hydromorphological reference condition, in a river reach – free from artificial channel constraints – a sustainable sediment regime is assumed to produce a corresponding hydromorphological condition, supporting the good ecological status.

EVALUATION CONCEPT

The application of the Hydromorphological Evaluation Tool (HYMET) for reach evaluation follows a three-step process (Figure 1). First, the connectivity of the reach to sediment production in its catchment is evaluated. In the second step, the sediment transfer through the river network to the downstream reach is analysed. In the last step, the reach itself is investigated for its own sediment budget and for its artificiality. The evaluation procedure is performed from catchment to reach scale in a hierarchical manner: the score assigned to the reach's catchment with respect to sediment supply defines the maximum score that can be achieved by the river network score concerning sediment transfer. In turn, the river network score is the maximum possible score that can be achieved by the final reach score. In contrast to existing methods for assessing the morphological quality of rivers, by following HYMET the sediment supply is considered as a prerequisite for sustainable functioning of morphodynamics. The hierarchical procedure ensures causal analysis of morphodynamics rather than interpretation of symptoms observed in the investigated reach.

Catchment

In a first step, the catchment of the investigated reach is investigated for artificial sediment barriers such as torrent control structures or weirs from hydropower plants. By assigning throughput coefficients to the sediment barriers the proportion of the produced sediment which has access to the river network of the reach is calculated. Artificial compensation of the sediment deficit downstream from weirs may be acknowledged. However, its contribution may be reduced by a sustainability weighing factor, which lets the user define the sustainability of compensation measures.

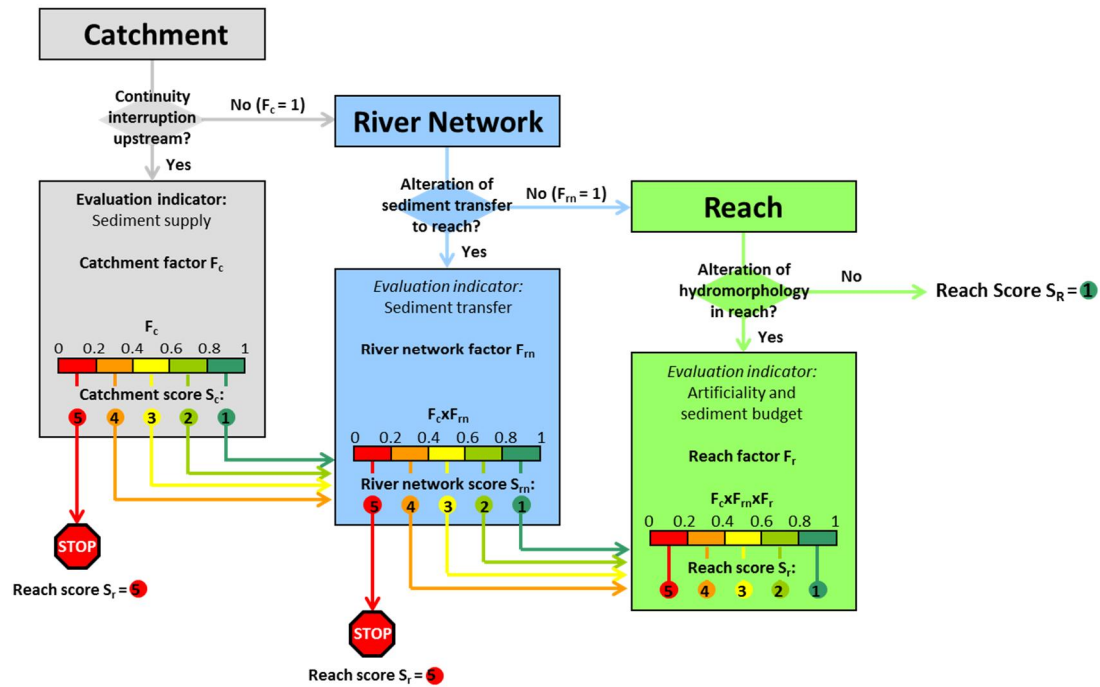

Figure 1. Concept of the Hydromorphological Evaluation Tool.

River Network

The river network is investigated for alterations of the transfer of sediment from the catchment to the downstream, investigated reach. River engineering works in the upstream river network may alter the sediment budget by changing the sediment transport capacity. Training works such as channel narrowing may increase bed shear stress and hence sediment transport. Moreover, gravel mining or artificial sediment supply affects the sediment budget of the river network. Degradation (bed level lowering and/or channel widening) in upstream reaches would increase, and aggradation (bed level increase as well as channel narrowing) would decrease the amount of sediment which is transferred downstream. Mostly, aggradation, degradation and especially dredging activities and artificial sediment supply occur over a limited time. A reduction or increase of sediment supply to the investigated reach would therefore imply that the actual morphological condition of the reach, whether it resembles a natural or an altered condition, is temporary. By evaluating the sediment transfer within the river network, the sustainability of the morphological condition is considered in the evaluation.

Depending on data availability, the sediment transfer through the river network may be calculated or estimated via expert knowledge. Frings et al. (2014) established a sediment budget for the regulated Rhine River for a 21-year period (1985-2006). Based on the budget components used in Frings et al. (2014), the following budget can be established for rivers, where bank erosion may occur (Figure):

$$(I_u + I_t + I_a + I_b) - (O_d + O_e + O_f + O_a) = \Delta S$$

with I_u sediment input from upstream, I_t sediment input from tributaries, I_a artificial sediment supply, O_d sediment transport out of the river section at the downstream end,

O_e sediment extraction, O_f floodplain sedimentation, O_a abrasion, and ΔS change of stored sediment due to bed level changes. Units are uniformly in tonnes/a or m^3/a .

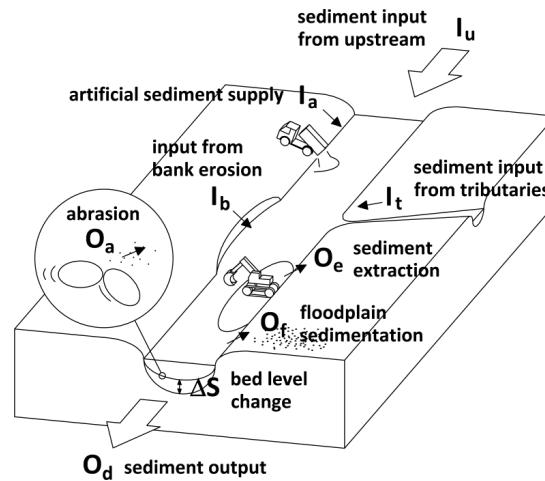

Figure 2. Components of sediment transfer determining the sediment supply to a downstream river reach.

In case the cross section surveys also cover the riverbanks and the floodplain, supply from bank erosion (I_b) and sediment output through floodplain sedimentation (O_f) may be subsumed together with bed level changes in ΔS . In a cross section downstream of a cross section with known sediment transport, the sediment transport can then be calculated via:

$$O_d = (I_u + I_a + I_t) - (\Delta S + O_e + O_a)$$

The obtained values for sediment transfer have to be evaluated with consideration of the flow events in the investigated time period. The results of sediment budget analyses tend to include significant temporal and spatial clumping (Walling, 1983), especially when obtained from short timeframes.

River reach

While morphodynamics evolve with local bed aggradation or degradation, within the length of the river reach the sediment budget has to be balanced in a dynamic equilibrium to maintain the morphological condition. This is investigated based on repeated surveys of the channel geometry (cross section surveys or surveys including the entire channel). Second, the degree of artificiality is evaluated at the reach scale, since the sediment budget in a reach may be balanced just because of artificial interference in the channel processes. Non-erodible crossing structures or artificial sediment supply may prevent bed degradation, and a narrowed channel due to groynes or repeated dredging may prevent aggradation.

The lateral constraints are assessed along the water edge at approximately mean discharge. There, the proportion of protected banks is calculated. If a bank is protected but not reached by the water edge (e.g. due to the presence of an alternate bar), this is not counted as a channel constraint. In contrast, submerged structures need to be fully

accounted for. Groyne constrain the channel over a larger length than the extent of the structure itself along the channel. To account for that, the length of the pool at the groyne head is used as a replacement length. The water edges along mid-channel bars are equally considered. Natural constraints (e.g., bedrock) are not considered as protected banks. The ratio between the length of water edges along structures and the overall length of the water edge describes the artificiality with respect to lateral channel boundaries. River morphology reacts very sensitive to vertical constraints, so that if a structure crosses the reach the reach factor is reduced to zero. At any rate the ecological status has to be separately evaluated.

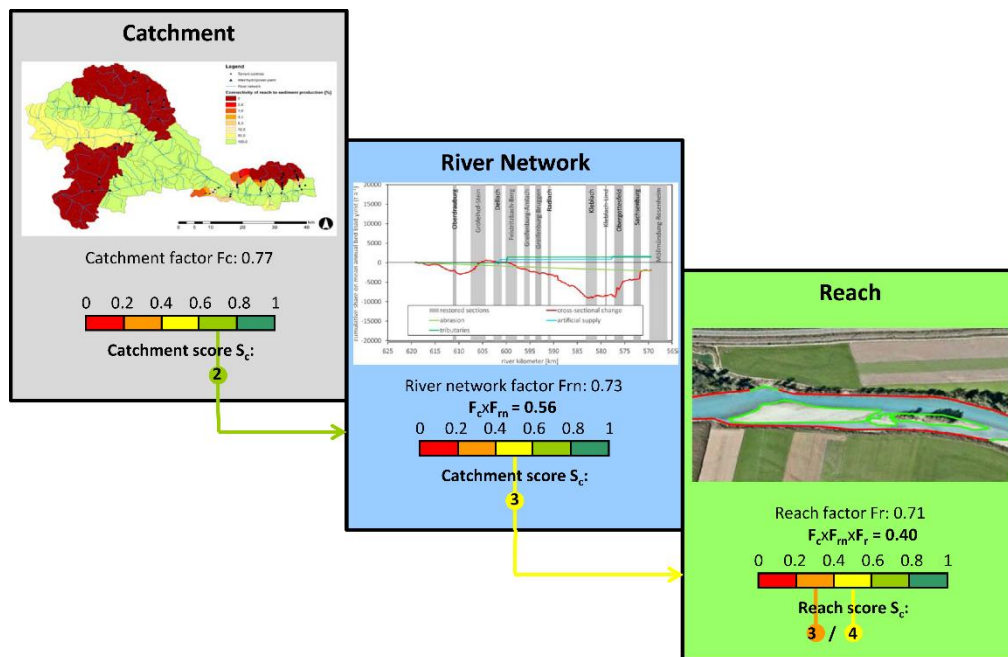

Figure 3. Factors determined at the different scales and scoring for a reach at the Upper Drau River.

APPLICATION

The application of HYMET is exemplified here on a reach of the Drau River. First, data was collected at the catchment level. The contribution of sub-catchments to the sediment production in the catchment of the evaluated reach was estimated based on the sub-catchment areas. A detailed map showing crossing structures and an estimation of sediment throughput coefficients at these barriers served for estimating the connectivity of the reach to its sediment sources and hence assessment of the catchment factor F_c (Figure). A catchment factor of 0.77 was derived for the catchment, which corresponds to a 'good' status and which already defines the maximum score possible for the final reach evaluation. The river network analysis revealed that sediment is not being transferred to the evaluated reach in the manner of a dynamic equilibrium; multiplication with the river network factor of 0.73 is further reducing the score down to 0.56 at the catchment level. The sediment budget of the restored reach itself appeared to be in equilibrium since its morphology adapted to the bed widening. However, the bank protections that are still constraining the channel produce a reach factor of 0.71, leading to a final reach score of 0.40, which corresponds to the threshold between an acceptable and a bad state. The obtained factors for each level are all below 1 and show a small variation (ranging between 0.71 and 0.77), suggesting the implementation of small

measures at every scale to improve the reach score and hence the conditions for morphodynamics in the evaluated reach.

SUMMARY

The Hydromorphological Evaluation Tool is essential for evaluating regulated or restored river reaches as a precondition for an integrated morphological quality assessment and to find measures at the appropriate scale. It is clear that in a hierarchical scaling dependency of the smaller scales from the larger ones the integration of catchment, landscape unit and segment scale processes is crucial for planning and implementation of sustainable river engineering measures, hydropower development, river restorations and flood risk management at the reach scale.

References

- European Commission, 2000. Directive 2000/60/EC of the European Parliament and of the Council of 23 October 2000 Establishing a Framework for Community Action in the Field of Water Policy. Official Journal L 327, 22/12/2000, Brussels, Belgium. 73 pp.
- Frings RM, Gehres N, Promny M, Middelkoop H, Schüttrumpf H, Vollmer S (2014): Today's sediment budget of the Rhine River channel, focusing on the Upper Rhine Graben and Rhenish Massif, *Geomorphology*, Volume 204, 573-587.
- Walling DE. 1983. The sediment delivery problem. *Journal of Hydrology* 65: 209–237.

Exploring spatial scales of geomorphical features driving macroinvertebrate communities (Duero basin, NW Spain)

Moreno-Garcia P et al.

PABLO MORENO-GARCÍA, MARTA GONZÁLEZ DEL TÁNAGO, JOAQUÍN SOLANA & DIEGO GARCÍA DE JALÓN

E.T.S. Ingeniería de Montes, Forestal y del Medio Natural, Universidad Politécnica de Madrid, 28040-Madrid, Spain

Introduction

Identifying linkages and interactions between hydrology and biota and between biota and morphology has been an important research issue within the REFORM Project (EU FP7, REstoring rivers FOR effective catchment Management). An initial step in analyzing these linkages and interactions is the adoption of appropriate spatial scales to assess the influence of fluvial processes on physical habitats and biological assemblages. Many attempts have been done in defining appropriate scales of measurement and interpretation of river systems. The hierarchical approach of river habitats in which larger-scale processes create forms and conditions that constrain processes and forms at successively smaller scales has been widely reported (Habersack, 2000; Poole, 2002). However, the patterns of biological communities corresponding to the hierarchical organization of river systems are not so clearly understood and still remain a challenge in linking stream ecology and fluvial geomorphology. The number of studies that explicitly examine the distribution and composition of stream biological assemblages at multiple scales is relatively small (Malmqvist, 2002). Scales of macroinvertebrate distribution have been reported by Parsons et al. (2003) and validation of river network spatial scales for fish communities has been recently analyzed by Wang et al. (2012).

Within the REFORM Project, a multi-scale hierarchical approach to characterize and assess the hydro-morphologic status of river reaches has been developed, identifying key hydro-geomorphic processes and indicators on different spatial scales, i.e. biogeographic region, catchment, landscape unit, river segment and river reach,. Our study aims to analyze if the macroinvertebrate assemblages within the Duero Basin reflect any correspondence with this hierarchical approach of hydro-geomorphic processes at different spatial scales.

Methodology

This research has been conducted in the Duero Basin, NW of Spain, from which a previous extensive macroinvertebrate study along the entire river network was available (García de Jalón & González del Tánago, 1986). In this former study, the macroinvertebrate communities were sampled in 75 river sites regularly distributed along 23 rivers. In each river site, four samplings corresponding to the four seasons of the year (i.e. winter, spring, summer and autumn) were carried on during 1981. Species composition and abundance were analyzed from each macroinvertebrate sampling. A total number of 75 species was considered for this research, from which 65 species with 18,000 individuals were found in winter, 66 species were found in spring, 64 species were found in summer and 64 species with were found in autumn, with a much bigger

number (18,000) individuals in winter than in the other periods (between 7,800 and 8,000).

At each sampling site, we applied the multi-scale hierarchical approach developed within the REFORM Project (Gurnell et al., 2014). Within the Spanish side of the Duero Basin we considered 4 different bio-geographical regions (Orocantabrian, Carpetano-Leonese, Castillan and Oroiberian) defined from www.globalbioclimatics.org maps.; 9 sub-basins which were referred to sub-regions or the main tributaries of the Duero basin (Upper Duero, Mid and Lower Duero, Pisuerga, Esla, Lowland rivers, Southeastern rivers, Adaja, Tormes and Southwestern rivers), 23 catchments (i.e. individual rivers), three landscape units and 75 river reaches. Catchments were characterized by their drainage area, geology and land cover (CORINE, 2006). Landscape units within the catchments were differentiated by their altitude and land cover and classified as "zones". We differentiated upper zones (elevation >900 m and forest land cover > 60 %), lower zones (elevation < 800 m and agricultural land cover > 60 %) and middle zones (river parts between the upper and lower zones). River segments were characterized by valley confinement and average annual flow. Finally, the river reaches in which the macroinvertebrate sampling was carried out were characterized by their channel slope and substratum. As the existing macroinvertebrate study of the Duero Basin responded to different research objectives, it did not include replicates at reach scale within river segments, and replicates of river segments within the landscape units. Therefore, in most of the cases we only had biological data from one site representing indistinctly the landscape unit, river segment and river reach scales; only in some landscape units of the sub-basins we had replicates of river segments. Apart from the hydro-morphological variables characterizing the spatial scales, some water quality attributes (i.e. electrical conductivity and nitrate concentration) were also considered as potential variables to explain macroinvertebrate community patterns. For this study we used abundance data of species from lotic habitats (i.e. coarse gravel substratum).

To search for any correspondence between macroinvertebrate communities and the hierarchical organization of river ecosystems we applied ANOVA and non-parametric similarity analysis (ANOSIM). ANOVA was addressed to analyze the variance of abundances of each species within and between spatial scales, and it was approached both independently for each spatial scale, and following a nested structure. The Least Square Difference (LSD) test was used to determine significant differences in abundances between pairs analyses. Within the ANOSIM, the Bray-Curtis Index was considered to quantify the compositional dissimilarity between two different sites or two different groups of sites (e.g. spatial scales). It was calculated as the ratio of the average between-group dissimilarity and the average within-group dissimilarity and it was computed by statistical tests. Additionally, we made a redundancy analysis (RDA) (Legendre and Legendre, 2012) to evaluate which part of the total variance (i.e. constrained inertia) was explained by spatial scales (i.e. biogeographic regions, sub-catchments, catchments, landscape units) and which part responded to environmental variables. In this case we used the Hellinger's distance index and some characteristics of the respective spatial scales as environmental variables (i.e. drainage area, % geological classes, % forest cover classes, elevation, valley type, average mean daily discharge, channel slope). We conducted all the statistical analyses using abundance data adding all

individuals found along the four sampling periods, and for each sampling period separately.

Results

Descriptive analyses using ANOVA tests showed that the abundances of certain species were significantly different within and between spatial scales. Independently, the biogeographical regions discriminated the abundance of 18 taxa, with major significance for *Ancylus fluviatilis*, *Echinogammarus* (Gammaridae), *Dinocras cephalotes* (Plecoptera, Perlidae) and 5 species of *Rhyacophila* (Trichoptera, Rhyacophilidae). The sub-basins discriminated the abundance of 32 species, the catchments discriminated that of 41 species and the landscape units did it with 57 taxa. Under a nested approach, from the 18 taxa discriminated at the bio-region scale, 22 additional taxa up to 40 taxa were significant for bio-region and the sub-basin scale, 8 species more up to 48 were significant when including the catchment scale and 9 additional species rising up to 57 showed significant differences in their abundance when the landscape unit scale was added to the previous ones. The taxa whose abundance was more closely associated with certain spatial scales belonged to the families Gammaridae, Heptageniidae, Perlidae, Rhyacophilidae and Hydropsychidae, whereas those with their abundance more independent from the spatial scales corresponded to the families Baetidae, Oligoneuriidae, Caenidae and Leptophlebidae (Ephemeroptera), Nemouridae and Perlodidae (Plecoptera), Glossosomatidae and Psychomidae (Trichoptera) and Simuliidae and Tabanidae (Diptera).

The ANOSIM analysis indicated that the landscape unit scale showed the highest correspondence with the macroinvertebrate communities when compared with the biogeographical region, sub-basin or catchment scales. The R-statistic values for the ANOSIM analysis (Fig. 1) revealed that the similarity of the macroinvertebrate assemblages was higher within landscape units than between them. The p-values obtained after 999 permutations were more significant ($p < 0.001$) for this scale and less significant ($p < 0.005$) or not significant for the others (Fig. 1). We applied ANOSIM using presence/absence data and abundance data. Although the presence/absence data gave better results than abundance data, the results showed the same patterns in both cases. The lowest R-statistic values were those of the landscape unit scale ($p < 0.001$) while those of the other spatial scales were higher and showed variable significance levels. Winter and summer data showed an expected general trend of the R-statistic values rising when the scale becomes smaller (i.e. higher similarity of macroinvertebrate communities within landscape units than within catchments, sub-basins or regions) but this trend was not shown in spring and autumn, although the number of species and individuals were similar among seasons.

The results from redundancy analyses studying individually the explicative power (i.e. constrained inertia) of each spatial scale and each environmental variable for macroinvertebrate communities is shown in Table 1.

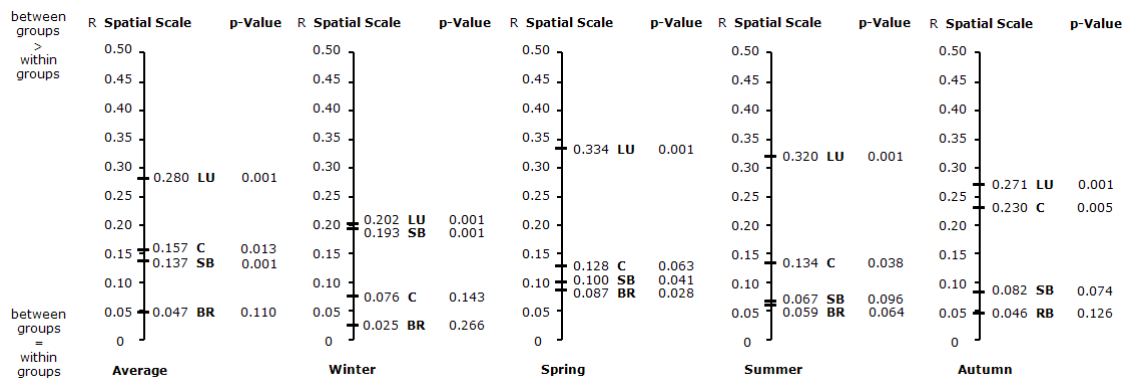

Figure 1. R and p-statistic values from the ANOSIM analysis testing the similarity of macroinvertebrate communities at different spatial scales: BR: Biogeographical Regions; SB: Sub-Basins; C: Catchments, LU: Landscape Units.

Table 1. Redundance analysis results using Hellinger’s distance index, indicating the explicative percentage of spatial scales or environmental variables (constrained inertia) and the residuals (unconstrained inertia).

Spatial scale /Environmental variable	Constrained Inertia	Unconstrained Inertia	Adjusted R ²
Biogeographic region	0.100	0.900	0.060
Sub-basin	0.179	0.821	0.073
Catchment	0.367	0.633	0.096
Landscape Unit	0.139	0.861	0.114
Channel slope	0.151	0.849	0.139
Altitude	0.139	0.861	0.126
Land Cover - % Forest	0.119	0.881	0.106
Catchment Area	0.085	0.915	0.072
Geology - Quaternary	0.078	0.922	0.064
Valley type	0.029	0.971	0.001
Geology - Calcareous	0.025	0.975	0.010
Geology - Siliceous	0.018	0.982	0.004
Geology - Mixed	0.017	0.983	0.003

The variances explained by catchment and sub-basin scales were higher than the ones explained by the others, what may be explained by the fact that the highest inertias are displayed on the scales that include more units, which is the case of the catchment (i.e. 23 rivers). The influence of the number of units is compensated when the R² statistic is adjusted. In our case, the results clearly show that the explicative/predictive power of the different scales is enhanced when the scale becomes smaller, which confirms the previous ANOSIM results. The analysis using environmental variables indicated that the slope, altitude and % of forest cover were the most explicative variables of macroinvertebrate communities. These variables were basically used to characterize the sampling sites at smaller scales (i.e. channel slope basically related to river reach or river segment scale and altitude and % forest cover related to landscape unit scale), whereas the rest of them (i.e., drainage area and geology) were used to characterize broader scales such as the catchment.

Finally, the results of applying a hierarchical approach to the redundancy analysis are shown in Table 2. The inertia partition analysis showed that biogeographical regions explained 10.1 % of the overall variance, the catchments added the greatest part, 34.7 % up to 44.8 % and the landscape unit interpreted an additional 8.5 % up to 53.3 %.

Table 2. Hierarchical approach of redundancy analysis with Hellinger's index.

Nested Scales	Constrained Inertia	Unconstrained Inertia	Adjusted R ²
Bioregion	0.101	0.900	0.060
Bioregion + Catchment	0.448	0.552	0.160
Bioregion + Catchment + Landscape Unit	0.533	0.467	0.256

Discussion and conclusions

These preliminary results suggest that the macroinvertebrate community response to the broader spatial scales is slight, but it increases progressively as the spatial scales become smaller. The landscape unit scale (the smallest in our case study) explained the most of macroinvertebrate communities in relation to the larger (i.e. catchment, sub-basin, biogeographic region) analyzed spatial scales. Exploring the influence of environmental characteristics separately we also found that those more related to hydromorphology, and especially to smaller spatial scales (i.e. channel slope, altitude) were also the best explicative variables of macroinvertebrate communities. These results are in agreement with previous findings where the lack of congruence between macroinvertebrate distribution and the larger geomorphological scales has been reported (Parsons et al, 2003).

Our research represents a post-hoc study with initial limitations of no replicates at smaller scales than landscape unit from the available data. However, the extension of the studied area and the taxonomic level of macroinvertebrate communities may represent a good case study for exploring linkages between spatial scales and macroinvertebrates. Further studies using contingent analyses and their extension to macroinvertebrate communities from lentic habitats will contribute to a better integration of geomorphological scales and macroinvertebrate communities.

Aknowledgements

The work leading to this paper was funded through the European Union's FP7 programme under Grant Agreement No. 282656 (REFORM).

References

- García de Jalón, D., González del Tánago, M. (1986). Métodos biológicos para el estudio de la calidad de las aguas. Aplicación a la Cuenca del Duero. Mongografías, 45. Publ. ICONA, Ministerio de Agricultura, Pesca y Alimentación, Madrid.
- Gurnell, A.M. and col.. 2014. A hierarchical multi-scale framework and indicators of hydromorphological processes and forms. Deliverable 2.1, a report in four parts of REFORM (REstoring rivers FOR effective catchment Management), a Collaborative project (large-scale integrating project) funded by the European Commission within the 7th Framework Programme under Grant Agreement 282656.
- Habersack, H. M. (2000). The river-scaling concept (RSC): a basis for ecological assessments (pp. 49-60). Springer Netherlands.
- Legendre, P., Legendre, L. F. (2012). Numerical ecology (Vol. 24). Elsevier.

- Malmqvist, B. (2002). Aquatic invertebrates in riverine landscapes. *Freshwater Biology*, 47(4), 679-694.
- Parsons, M., Thoms, M. C., Norris, R. H. (2003). Scales of macroinvertebrate distribution in relation to the hierarchical organization of river systems. *Journal of the North American Benthological Society*, 22(1), 105-122.
- Poole, G. C. (2002). Fluvial landscape ecology: addressing uniqueness within the river discontinuum. *Freshwater Biology*, 47(4), 641-660.
- Wang, L., Brenden, T., Cao, Y., Seelbach, P. (2012). Delineation and validation of river network spatial scales for water resources and fisheries management. *Environmental management*, 50(5), 875-887.

Distinct patterns of interactions between vegetation and river morphology

Van Oorschot M et al.

MIJKE VAN OORSCHOT^{1,2}, MAARTEN KLEINHANS², HANS MIDDELKOOP², GERTJAN GEERLING¹, TOM BUIJSE¹ & ERIK MOSSELMAN^{3,4}

¹*Department of water quality & ecology, Deltares, PO Box 177, 2600 MH, Delft, the Netherlands*

²*Faculty of Geosciences, Universiteit Utrecht, PO Box 80115, 3508 TC, Utrecht, the Netherlands*

³*Department of river dynamics and inland water transport, Deltares, PO Box 177, 2600 MH, Delft, the Netherlands*

⁴*Faculty of Civil Engineering and Geosciences, Delft University of Technology, PO Box 5048, 2600 GA, Delft, the Netherlands*

Riparian vegetation interacts with morphodynamics by influencing river banks and causing hydraulic resistance. Modelling vegetation and morphodynamics is often one-way traffic that either takes into account the effect of vegetation on morphodynamics or vice versa. We coupled a morphodynamic model to a novel dynamic vegetation model to test the hypothesis that dynamic vegetation creates more realistic patterns in vegetation and fluvial morphology as opposed to the 'old fashioned' static vegetation. We find that dynamic vegetation as opposed to static vegetation predicts more natural patterns and dynamics in vegetation and fluvial morphology.

INTRODUCTION

Riparian vegetation interacts with morphodynamics to create a biodiverse landscape mosaic (Tockner and Stanford, 2002). Vegetation can reinforce or destabilize river banks and alter the flow field and sediment balance through hydraulic resistance (Simon and Collison, 2002; Rinaldi and Casagli, 1999; Zong and Nepf (2011).

Despite of the numerous conceptual models, there is a discrepancy in process-based modelling of these dynamic interactions. Advanced physics-based models include complex morphodynamics, but simplistic vegetation, while cellular automata include more advanced ecological processes, but simplistic morphodynamics (Camporeale 2013). Here we present the results of a novel dynamic vegetation model coupled to an advanced morphodynamic model. The aim of our work is to investigate the emergent patterns in vegetation and river morphology at the river reach scale by dynamically modelling the processes and their interactions. We want to test the hypothesis that dynamic vegetation creates more realistic patterns in vegetation and fluvial morphology as opposed to the 'old fashioned' static vegetation

We compared three different scenarios; a scenario without vegetation, a scenario with commonly used static vegetation and a scenario with dynamic vegetation containing all advanced vegetation processes.

METHODS

We have coupled the morphodynamic model Delft3D to a novel dynamic riparian vegetation model. The morphodynamic model was designed to represent average morphodynamic characteristics and hydrology of the Allier river in France (Figure 1). The vegetation model interacted with the morphodynamic model through hydraulic resistance every two weeks.

The vegetation model includes colonization, growth and mortality. Colonization takes place depending on the timing of seed dispersal and the water levels during that period. Growth of vegetation shoot, root and stem diameter is calculated with a logarithmic growth function based on age. Plant properties can change at different life stages and multiple vegetation types with different ages can reside in one grid cell. Mortality of vegetation depends on days of subsequent flooding, days of subsequent desiccation, high flow velocities, burial and scour.

Three scenarios were tested: 1) no vegetation, which is the control run of the morphodynamic model without vegetation, 2) static vegetation, where vegetation could colonize and cause flow resistance but did not grow or die, and 3) dynamic vegetation, including all dynamic processes. The vegetation types in the dynamic scenario are loosely based on Salicaceae species with ecosystem engineering properties. The vegetation type in the static scenario is based on an average Salicaceae bush.



Figure 1. Aerial photo of the study area; Allier river in France.

RESULTS

The three scenarios show clear differences in river morphology after 300 years (Figure 2). The scenario without vegetation develops towards a straight channel with low sinuosity (Figure 2A). Both scenarios with vegetation show a dynamically meandering river with chute cut-offs, oxbow lakes and vegetation patterns comparable to the Allier river (Figure 2B and Figure 2C). However, the static scenario has a broader floodplain and sharper meander bends with a bigger amplitude than the dynamic scenario.

The scenarios with static and dynamic vegetation show large differences in the vegetation cover and dynamics. The scenario with static vegetation has a dense cover (Figure 2B) which is not very dynamic, while the scenario with dynamic vegetation has a much lower vegetation cover with higher dynamics (Figure 2C).

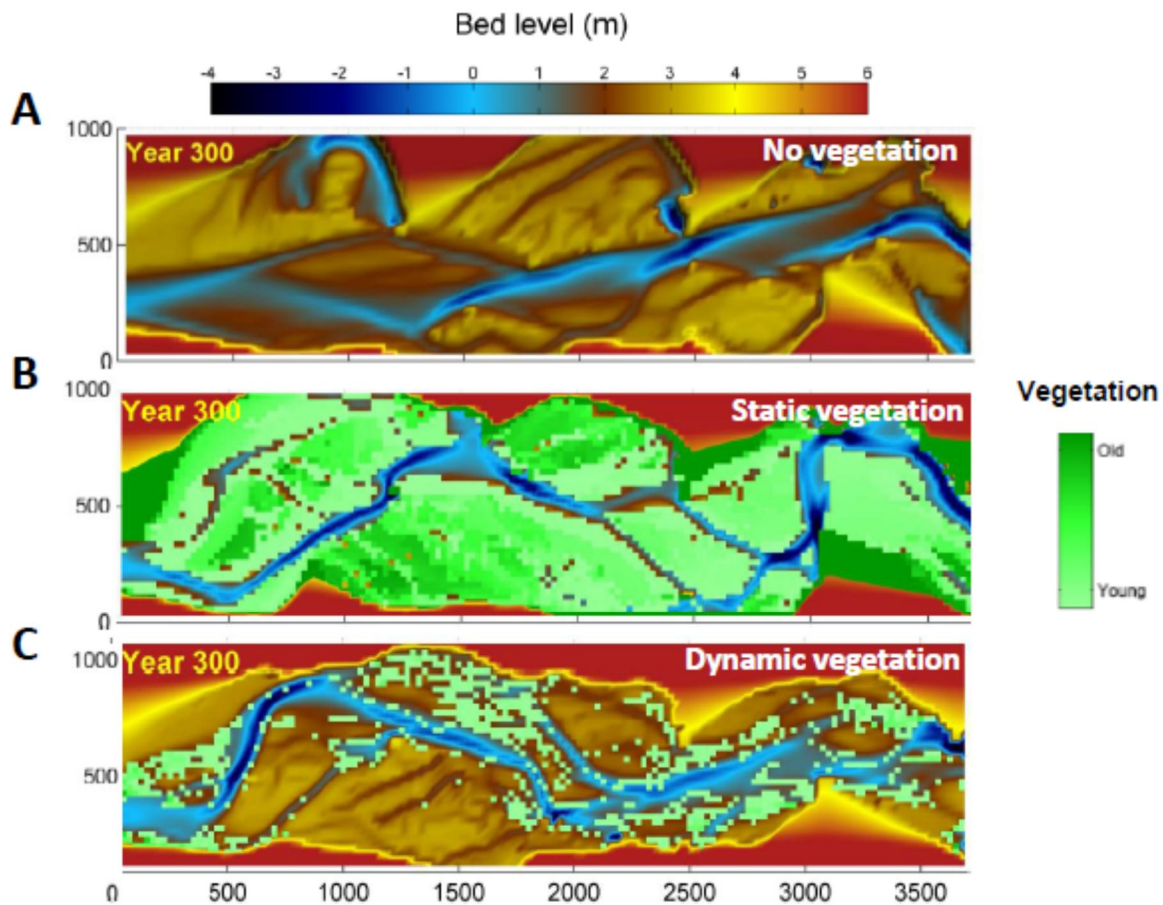

Figure 2. River morphology and vegetation pattern after 300 years for A) the scenario without vegetation, B) with static vegetation and C) with dynamic vegetation.

Discussion and conclusions

The results show distinct differences in river morphology between the scenarios after 300 years. Without vegetation, the river develops into a straight channel, while the scenarios with vegetation show a dynamically meandering system. This confirms that inclusion of vegetation creates a single thread, meandering river, which is in line with other modeling studies (Crosato and Saleh, 2011; Nicholas, 2013) and flume experiments (Van Dijk, 2013; Tal & Paola, 2010). Additionally, we find that river morphology is very sensitive for the way vegetation is defined, either static or dynamic, which is a direct effect of vegetation location and density. Furthermore, the vegetation cover of the static scenario is very dense, while the vegetation cover of the dynamic scenario is less dense and more dynamic, which is in the same range as vegetation cover and age distribution derived from field data by Geerling *et al* (2006). This shows that dynamic vegetation creates natural vegetation patterns, leading to a more realistic interaction with morphodynamics and consequently a more natural river morphology.

References

Camporeale, C., Perucca, E., Ridolfi, L., & Gurnell, A. M. (2013). Modeling the interactions between river morphodynamics and riparian vegetation. *Reviews of Geophysics*, 51, 1–36.

- Crosato, A. & Saleh, M.S. (2011) Numerical study on the effects of floodplain vegetation on river planform style. *Earth Surface Processes and Landforms*, 36, 711–720.
- Geerling, G., Ragas, A. M. J., Leuven, R. S.E., van Den Berg, J., Breedveld, M., Liefhebber, D., & Smits, A. J. M. (2006). Succession and rejuvenation in floodplains along the river Allier (France). *Hydrobiologia*, 565, 71–86.
- Nicholas, A.P. (2013) Modelling the continuum of river channel patterns. *Earth Surface Processes and Landforms*, 38, 1187-1196.
- Rinaldi, M., & Casagli, N. (1999). Stability of streambanks formed in partially saturated soils and effects of negative pore water pressures: the Sieve River (Italy). *Geomorphology*, 26, 253–277.
- Simon, A., & Collison, A. J. C. (2002). Quantifying the mechanical and hydrologic effects of riparian vegetation on streambank stability. *Earth Surface Processes and Landforms*, 27, 527–546.
- Tal, M., & Paola, C. (2010). Effects of vegetation on channel morphodynamics: results and insights from laboratory experiments. *Earth Surface Processes and Landforms*, 35, 1014–1028.
- Tockner, K., & Stanford, J. A. (2002). Riverine flood plains: present state and future trends. *Environmental Conservation*, 29, 308–330.
- Van Dijk, W. M., Teske, R., van de Lageweg, W. I., & Kleinhans, M. G. (2013). Effects of vegetation distribution on experimental river channel dynamics. *Water Resources Research*, 49, 7558–7574.
- Zong, L., & Nepf, H. (2011). Spatial distribution of deposition within a patch of vegetation. *Water Resources Research*, 47, 1-12.

Assessing the effect of a catchment-scale restoration project in Wallonia (Belgium)

Peeters A et al.

ALEXANDRE PEETERS

*Hydrology and Fluvial Geomorphology Research Centre, University of Liège,
Allée du 6 août, 2 Bât. B11, 4000 Liège, Belgium*

GISÈLE VERNIERS

*Research Unit in Environmental and Evolutive Biology, University of Namur,
Rue de Bruxelles, 61, 5000 Namur, Belgium*

BERNARD DE LE COURT

*Unnavigable Watercourse Departement, Service Public de Wallonie,
Avenue Reine Astrid, 39, 5000 Namur, Belgium*

In the context of fulfilling the Water Framework Directive requirements, the LIFE+ project Walphy allowed experimental restoration projects to be undertaken on two medium-size catchments of the Meuse basin in Wallonia (Belgium) between 2009 and 2014. A multi-scale assessment of hydromorphological conditions of the Bocq catchment has led to a large-scale restoration project through the removal or modification of 22 barriers and through the rehabilitation of 13 km of modified reaches. The success of the restoration projects was evaluated on the basis of a multi-disciplinary monitoring.

Introduction

The LIFE+ project Walphy was launched in 2009 in order to develop a methodology and tools for attaining the "good ecological status" defined by the European Water Framework Directive. In order to accomplish this, a large-scale restoration project was undertaken on two medium-size catchments of the Meuse basin in Wallonia (Belgium). This five-year long project was funded by the European Union and the *Service Public de Wallonie (SPW)*. It involved three institutions: the SPW was in charge of the experimental restoration projects while the Universities of Liège and Namur were responsible for evaluating the success of the restoration projects.

Description of the study sites

In this paper we focus on the Bocq catchment except its tributary, the Crupet stream. It has a 230 km² drainage area which is covered in order of importance by grassland, cropland and forest. The Bocq is a gravel-bed river, with bed material composed of sandstone (upper Devonian) and limestone (Carboniferous) pebbles.

Its lower course is characterized by a medium slope (6-7 ‰) and a high energy (specific stream powers at the bankfull stage: ~130 W/m²). During recent centuries, this course has been strongly impacted by numerous barriers which impede the free movement of fish and bedload (an average of one weir every 1.8 km).

Its middle course has a lower slope (2 ‰) and thus a lower energy (specific stream powers at the bankfull stage: ~20 W/m²). In some reaches, the river channel has been straightened over the last few centuries, which has led to significant loss of habitat.

Multi-scale assessment and site selection

Before undertaking sustainable rehabilitation measures, a multi-scale assessment of hydromorphological conditions (water body, reach and site) was conducted in order to define river restoration projects.

An evaluation of hydromorphology was first carried out at the water body scale using the Qualphy index (Demortier & Goetghebeur, 1996). The water system was sectorised into homogeneous river reaches using geomorphic variables. The evaluation of each reach was then based on 40 parameters characterizing the river system and its human-induced disturbances (figure 1). In addition, a survey of fish barriers was carried out (figure 2) and their effect on bedload transport was assessed. Finally, historical maps and LIDAR data were used to identify old watercourses. This evaluation helped river managers to identify the most degraded reaches and the causes of alteration.

Finally, the site selection for restoration was made among the most altered reaches on the basis of land issues and project opportunities. The rehabilitation measures were defined after detailed on-site analysis and negotiation with local stakeholders.

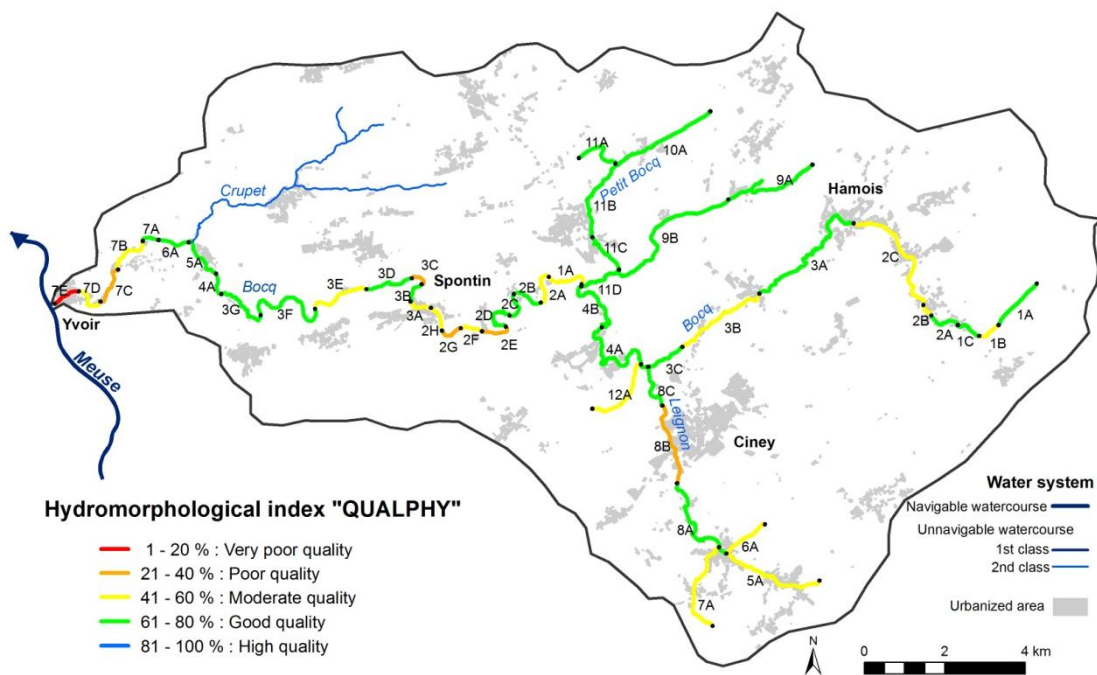

Figure 1: Qualphy index on the Bocq catchment before the Walphy project (Van Brussel, 2005 ; Verniers et al., 2009).

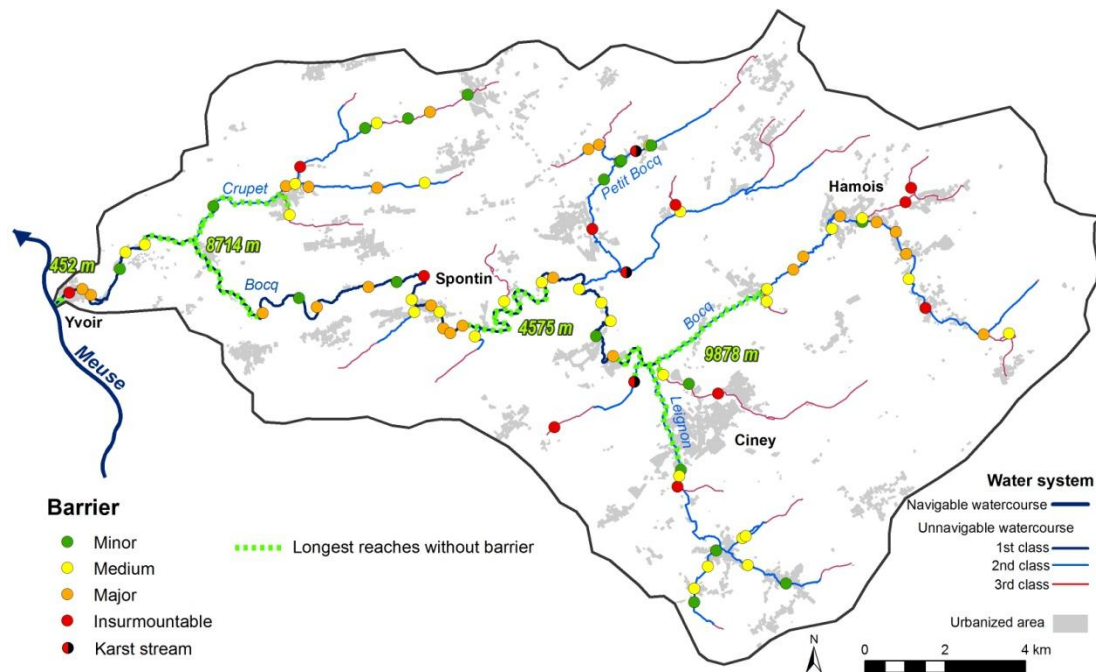

Figure 2: Fish barrier survey on the Bocq catchment before the Walphy project (modified from Fédération des sociétés de pêche Vesdre Amblève, 2004).

Restoration projects

The Bocq catchment has been subject to a large-scale restoration project implemented mainly in the lower and middle course of the Bocq River itself.

22 barriers (mainly old weirs of an average height of 1.35 m) have been removed or modified in order to reconnect the Bocq with the Meuse and to improve access to areas of spawning grounds (figure 3). We implemented a wide variety of technical solutions at an average cost of 68,396 €. Weir removal and by-pass channel were the most frequent options and the most economical. To date, only two barriers remain in the middle Bocq. In addition, 13,3 km of modified reaches were improved through a wide range of rehabilitation techniques such as designing sinuous channels, re-instating spawning grounds, improving fish shelters, improving culvert bed, etc. (Peeters et al., 2013). The rehabilitation focused on the most degraded reaches except in urban area where only few restoration measures could be implemented.

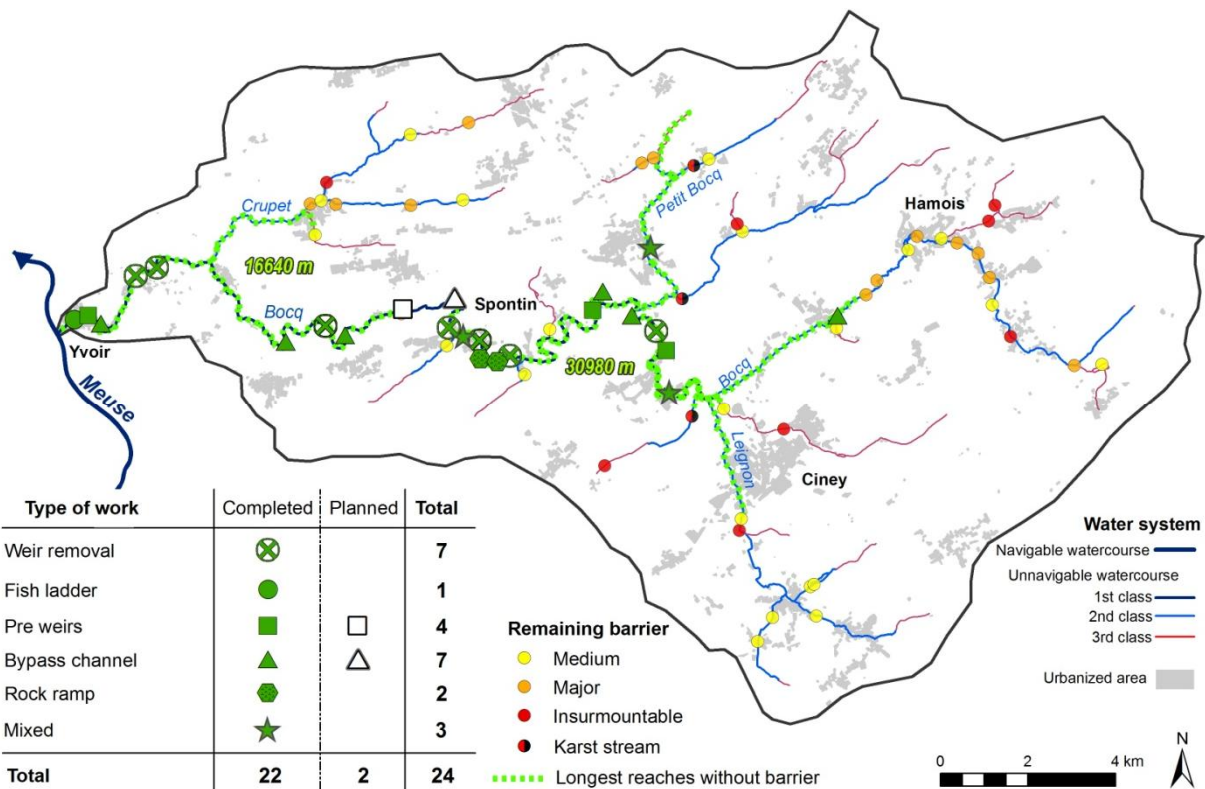

Figure 3: Restoration of the river continuity on the Bocq catchment

A multi-disciplinary monitoring

The success of the restoration projects was evaluated on the basis of a multi-disciplinary monitoring.

Hydromorphological quality was evaluated on five restored sites using microhabitat survey (Pouilly et al., 1995) and three indices of physical quality. For all sites, hydromorphology was significantly improved 1-2 years post-rehabilitation, through the diversification of flows (depth, substrate, water velocity) and the creation of habitats (e.g. fish shelters, spawning areas and woody debris). For example, meandering the Bocq at Emptinale has increased the microhabitat heterogeneity (figure 4), which results in an improvement of the morphological indices. This is especially the case for the reach index (Téléos, 2010) which has increased from poor quality to very good quality.

Assessment of biological quality was based on macroinvertebrates and fish communities. Biological indices have generally showed a status quo or a slight increase 1-2 years post-completion. Nevertheless, ambitious rehabilitation measures such as weir removal and meanders restoration have resulted in the most positive effects, while less ambitious measures such as habitat diversification have led to more contrasted results. The example of the Bocq at Emptinale have showed an improvement of macroinvertebrates (IBGN index increased from 9/20 to 16/20) and fish communities (IBIP index increased from 22/30 to 24/30; biomass from 75 to 222 kg/ha) post-completion. In addition, restoration of the longitudinal connectivity was beneficial for Grayling, designated as Natura 2000 species, and for eels, concerned with the Benelux convention.

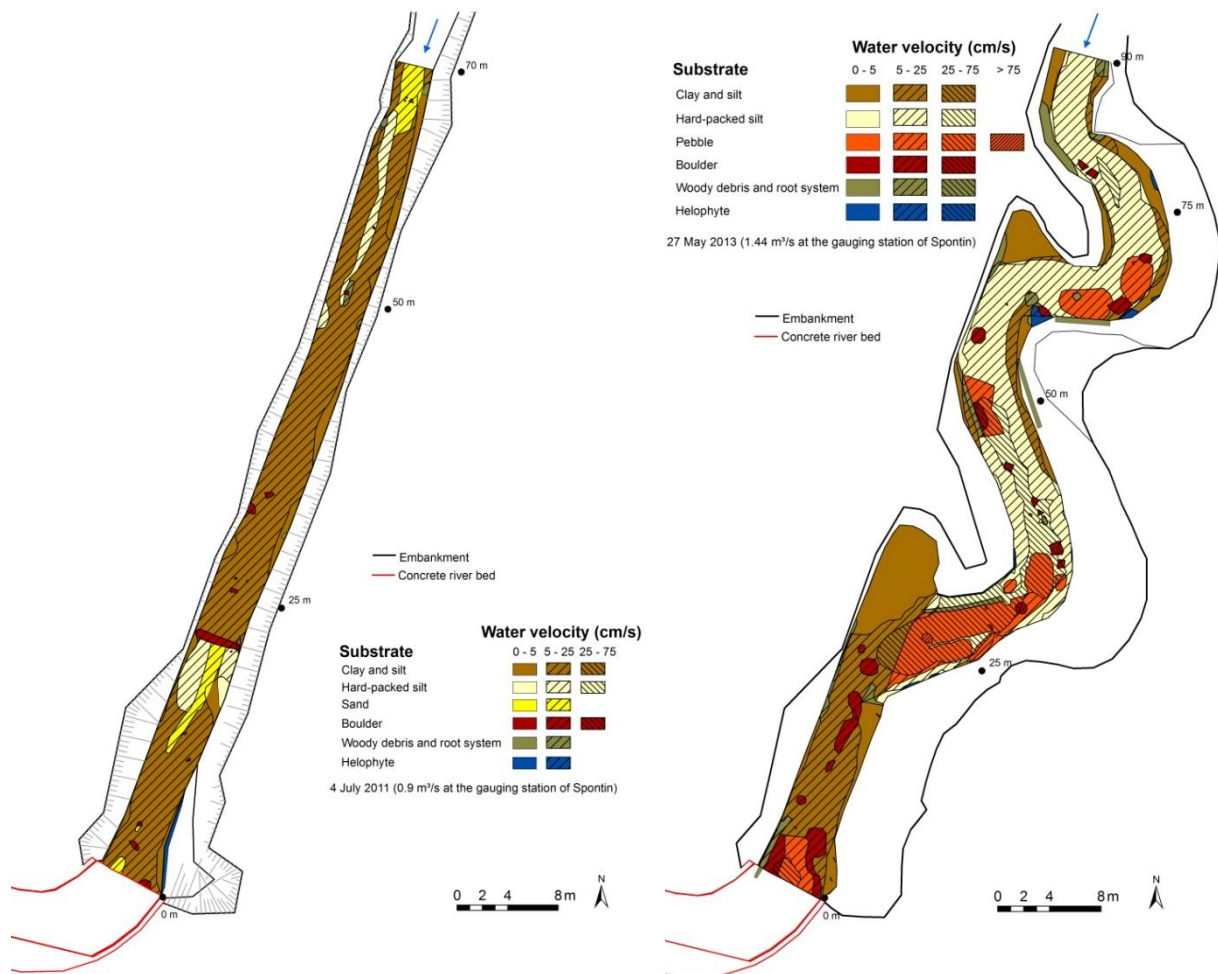

Figure 4: Microhabitats on the Bocq at Emptinale before (left) and after (right) rehabilitation

The geomorphological monitoring has focused on the effect of barriers on sediment transport. For example, topographic surveys and the use of pebble tracers have highlighted a natural bedload transport following a weir removal on the Bocq. Changes to the in-channel morphology (e.g. aggradation, erosion) were analysed following several geomorphologically effective floods.

The effectiveness of spawning gravel rehabilitation was monitored using tagged pebbles and wooden stakes inserted into the gravel bed of three sites. We highlighted for a single site that spawning gravels were unmovable and then subject to clogging. For the rest of the sites, spawning gravel were dispersed downstream after a variable number of flood (depending on the site), reducing the thickness of the spawning ground (example at the figure 5).

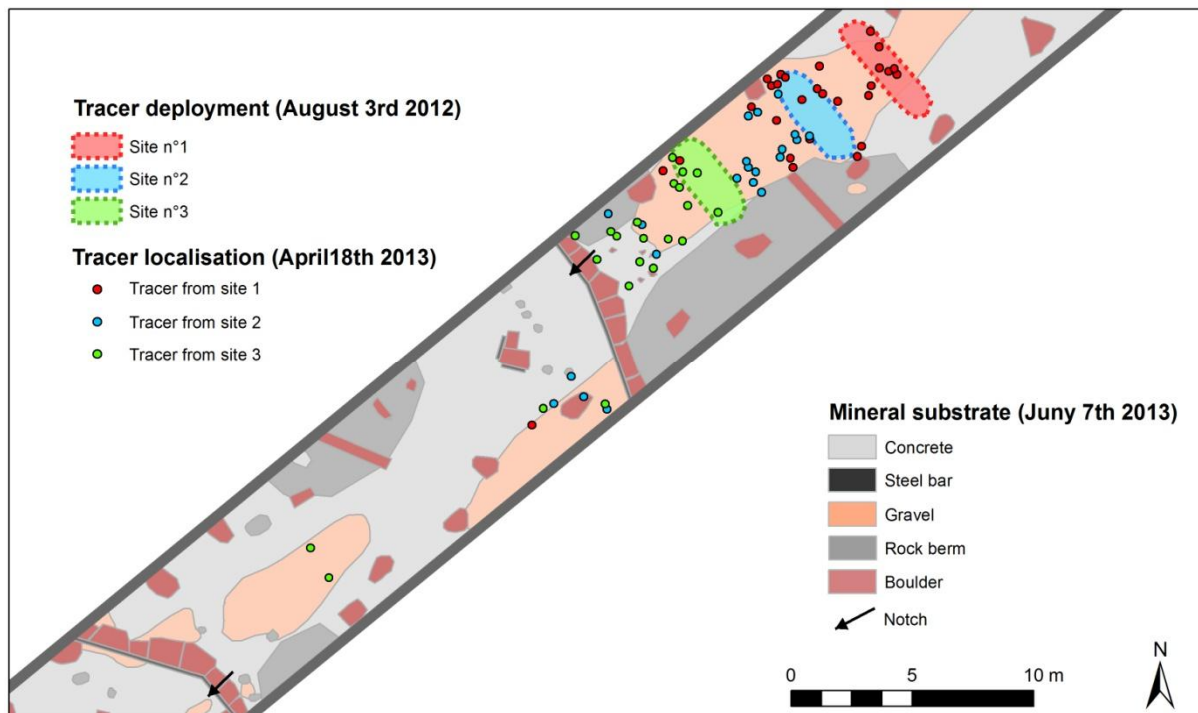

Figure 5: Monitoring of spawning gravel rehabilitation using tagged pebbles on the Bocq at Spontin: tracer localization after a medium discharge ($6.1 \text{ m}^3/\text{s}$)

Conclusion

This large-scale restoration project has been conducted in a relatively short period of time (5 years) considering the significant amount of work. Furthermore, the site-scale monitoring has highlighted a clear improvement in hydromorphology and a less pronounced improvement in biology. The water bodies have been reclassified from heavily modified to natural. Assessments of the biological effects at the water body scale are in progress and we expect the two water bodies to be improved in a longer period of time.

References

- Demortier G. & Goetghebeur P. (1996). Outil d'évaluation de la qualité du milieu physique des cours d'eau - Synthèse. Agence de l'Eau Rhin Meuse 78 pp.
- Fédération des sociétés de pêche Vesdre Amblève (2004). Inventaire des obstacles physiques à la libre circulation des poissons dans le réseau hydrographique wallon, Bassin du Bocq, Convention Etude Fédération des Sociétés de Pêche Vesdre Amblève Ministère de la Région Wallonne, Direction Générale des Ressources Naturelles et de l'Environnement, Direction des Cours d'eau non navigables.
- Pouilly M., Valentin S., Capra H., Ginot V. et Souchon Y. (1995). Note technique : méthode des microhabitats, principes et protocoles d'application. Bull. Fr. Pêche Pisc. 336: 41-54.
- TELEOS (2010). Formation aux méthodes de détermination de la qualité physique des cours d'eau. Méthode Qualité Physique à l'échelle du Tronçon. Méthode IAM. Bureau d'études TELEOS Suisse, Montmelon 85 pp.
- Peeters A., de le Court B. et Verniers G. (2013). Walphy, la restauration des cours d'eau en Wallonie: premiers retours d'expériences, Guide technique, 62 pp.
- Van Brussel S. (2005). Evaluation de la qualité physique des cours d'eau à l'aide de l'outil Qualphy, étude de cas appliqué au Bocq. Mémoire de fin d'études spécialisées en Science et Gestion de l'Environnement, Université Catholique de Louvain - Maison wallonne de la pêche, 89 pp.
- Verniers G., Peeters A., Latli A., Hallot E. et Petit F. (2009). Walphy, rapport II, Restauration du Bocq, états des lieux, 63 pp.

Application of the Morphological Quality Index (MQI) to European case studies

Nardi L et al.

NARDI L.¹, RINALDI M.¹, BELLETTI B.¹, COMITI F.², GOLFIERI B.³, MARCHESE E.¹,
SURIAN N.³, BRABEC K.⁴, GIEŁCZEWSKI M.⁵, HELLSTEN S.⁸, KAUFMAN S.⁶,
MARCINKOWSKI P.⁵, MUHAR S.⁶, OKRUSZKO T.⁵, PAILLEX A.⁷, POPPE M.⁶, RÄÄPYSJÄRVI
J.⁸, SCHIRMER M.⁷, STELMASZCZYK M.⁵

¹*Department of Earth Sciences, University of Firenze, Via S.Marta 3, 50139 Firenze, Italy*

²*Faculty of Science and Technology, Free University of Bozen-Bolzano, Piazza Università
5, 39100 Bolzano, Italy*

³*Department of Geosciences, University of Padova, Via Gradenigo 6, 35131 Padova, Italy*

⁴*Research Centre for Toxic Compounds in the Environment, Masaryk University,
Kamenice 753/5, 62500 Brno, Czech Republic*

⁵*Department of Hydraulic Engineering, Warsaw University of Life Sciences,
Nowoursynowska 159, 02-776, Warsaw, Poland*

⁶*Institute of Hydrobiology and Aquatic Ecosystem Management, University
of Natural Resources and Life Sciences Vienna, Max-Emanuel-Straße 17, 1180 Vienna,
Austria*

⁷*SIAM and W+T Departments, Eawag, Swiss Federal Institute of Aquatic Science and
Technology, Ueberlandstrasse 133, CH-8600 Dübendorf, Switzerland*

⁸*Finnish Environment Institute SYKE, Freshwater Centre, P.O. Box 413, FI-90014
University of Oulu, Finland*

The Morphological Quality Index (MQI) and the Morphological Quality Index for monitoring (MQIm) have been applied to eight case studies with the objectives of: (1) testing and improving the new versions of the indices, and (2) analyzing the hydromorphological response to various restoration measures. For each restored reach, the two indices were applied to the pre-restoration and post-restoration conditions. The restored reach was also compared to an adjacent, degraded reach. Results show that in all cases the restoration measures improved the morphological quality of the reach, but that the degree of improvement depends on many factors, including the initial morphological conditions, channel morphology, the length of the restored portion in relation to the reach length, and on the type of intervention.

Introduction

The Morphological Quality Index (MQI) and Morphological Quality Index for monitoring (MQIm) are two related tools originally developed in Italy (Rinaldi et al., 2013) and then adapted to be applied in other European countries in the context of the REFORM project (REstoring rivers FOR effective catchment Management). The MQI is designed to assess the overall morphological conditions of a stream reach, whereas the MQIm is a specific tool for monitoring changes in morphological conditions (enhancement or deterioration).

The two indices have been applied to eight case studies which included restoration measures, with the main objectives of: (1) testing and improving the new versions of the indices which aim at better representing those alterations and channel morphologies

which were under-represented in the original version of the MQI and MQIm, but which can occur throughout Europe, and (2) analyzing the hydromorphological response to various restoration measures.

In this paper, a summary of these applications is outlined and some results are discussed in a preliminary way.

Case studies

Seven rivers among the case studies of the REFORM Work Package 4 (Kail et al., 2014), with the addition of the Aurino River, were analysed. All the eight case studies include restoration measures, and were selected within different biogeographical regions of Europe in order to represent a sufficiently wide range of physical conditions. The main characteristics of the case studies are summarised in Table 1.

The analysed reaches were delimited according to the REFORM multiscale, delineation framework (see section 3). Reach length ranges from a minimum of 1.16 km (Aurino) to a maximum of 5.85 km (Vääräjoki). Most of the investigated reaches are unconfined; bed slope ranges from 0.02% (Narew) to 0.5% (Thur and Töss); bed sediment ranges from sand to boulders; channel morphologies include straight, sinuous, meandering, wandering and anabranching types. The restored length (Table 1) refers to the percentage of the restored portion over the total reach length (in the case of anabranching channels, the total reach length is the sum of the length of all the anabranches). This ranges from a minimum of 4.4% (Töss) to a maximum of 100% (Aurino).

Restoration measures mainly include removal of bank protections and/or artificial levées, channel widening, reconnection or construction of secondary channels and instream measures for habitat enhancement. Introduction of large wood along the Lippe River, and bed level raising by the re-introduction of sediment along the Aurino River were carried out in combination with some of the previous measures. One particular case is that of the Becva River: here, removal of bank protections and channel widening occurred in response to an intense flood event, so restoration consisted of leaving the channel morphology and avoiding to fix the banks again.

Data collection and methods

The Morphological Quality Index (MQI) is a method used for assessing morphological conditions (Rinaldi et al., 2013, 2015). The evaluation is based on a scoring system and includes twenty-eight indicators divided into three components (geomorphological functionality, artificiality, channel adjustments). The final score ranges from 0 (worst conditions) to 1 (reference conditions).

The Morphological Quality Index for monitoring (MQIm) is a specific tool used for monitoring the tendency of morphological conditions (enhancement or deterioration) in the short term, and is particularly suitable for the environmental impact assessment of interventions, including restoration measures (Rinaldi et al., 2015).

Application of the indices to the case studies required a first phase of minimum delineation, according to the procedure defined by Rinaldi et al. (2013), which is fully

consistent with the REFORM multi-scale, delineation framework (Gurnell et al., 2014). This consisted of defining the main landscape units and segments at catchment scale, and delineating the reaches only within the segment of application (i.e., where the restoration was located). Segmentation required the collection and analysis of geology, land use, available DEMs and satellite images.

Table 1 Main characteristics of the case studies. Bed sediment: G: gravel; S: sand; B: boulders. Confinement: PC: partly confined; U: unconfined. Morphology: M: meandering; S: sinuous; W: wandering; A: anabranching; St: straight. Q_{mean} : mean annual discharge. Measures: RB: removal of bank protections and/or artificial levées; W: channel widening; SC: reconnection or construction of secondary channels; BLR: bed level raising; IM: instream measures for habitat enhancement; LW: introduction of large wood. Case studies are listed in alphabetic order.

	Aurino	Becva	Drau	Lippe	Narew	Thur	Töss	Vääräjoki
Country	I	CZ	A	D	PL	CH	CH	SF
Altitude (m a.s.l.)	840	232	570	72	108	371	453	60
Catchment area (km ²)	629	1532	2433	1954	3680	1605	188	835
Reach length (km)	1.16	2.04	1.95	2.28	5.42	1.77	4.74	5.85
Bed slope (%)	0.1	0.2	0.14	0.05	0.02	0.5	0.5	0.13
Bed sediment	G	G	G	S	S	G	G	B
Confinement	PC	U	U	U	U	U	PC	U
Morphology	M	S	W	S	A	W	St	S
Q_{mean} (m ³ /s)	20.0	16.6	62.6	23.5	15	52.9	9.9	9.9
Restored length (%)	100.0	22.1	97.4	85.5	29.2	87.6	4.4	23.9
Restoration date	2007-2010	1997	2002-2003	1997	1995-2015	2002	1999-2010	1997-2006
Main measures	RB, W, SC, BLR	RB	RB, SC	RB, W, LW	SC	RB, W	IM, RB	IM

The MQI and MQIm are applied at the reach-scale by an integration of remote sensing – GIS analysis and field survey. For each case study, the MQI was applied to the restored reach vs. an adjacent, degraded reach. This was possible for most of the reaches, with the exception of the Töss River, for which an adjacent reach with comparable characteristics (in terms of confinement, degree of artificiality, etc.) was not available. Then, the MQI and MQIm were both applied for all case studies to the pre-restoration vs. post-restoration conditions along the restored reach. The time interval between pre- and post-restoration is variable, given that pre-restoration refers to the conditions before the restoration date (Tab. 1), while post-restoration refers to the current conditions (2014).

Once the study reaches were delineated, existing material at reach scale was examined, including: (i) the most recent remote sensed images representing the current river conditions; (ii) historical aerial photos (when available); (iii) map layer of interventions (when available), including information on relevant structures responsible for the alteration of flows and/or bedload interception in the sub-catchment upstream from the

reach. After a preliminary remote sensing – GIS analysis, a field survey was carried out for all investigated reaches followed by the GIS analysis and the measurement of quantitative parameters.

Some results

A summary of the overall results is reported in Figure 1. A first analysis of the results clearly shows that the initial morphological quality (before restoration) of the restored reach is extremely variable, ranging from poor (MQI=0.34, Becva) to good (MQI=0.8, Vääräjoki). In more detail, one case (Becva) falls into the class 'poor' (i.e., $0.3 \leq MQI < 0.5$); five cases (Aurino, Drau, Lippe, Thur, Töss) in the class 'moderate' (i.e., $0.5 \leq MQI < 0.7$); two cases (Narew, Vääräjoki) in the class 'good'. No cases fell into very poor ($MQI < 0.3$) or very good ($MQI \geq 0.85$) initial conditions. It is clear that, in most cases, pre-restoration hydromorphological conditions were critical (poor or moderate classes) and restoration was actually aimed at enhancing some morphological processes and/or forms, but in two cases initial morphological quality was not a main issue and restoration measures were mainly addressed to enhancing ecological conditions.

In general, as expected, in all the cases the hydromorphological measures undertaken by the restoration projects improved the morphological conditions. However, the enhancement of morphological quality was variable, and the reasons for this are preliminarily discussed in the next section. We used the increment of MQIm ($\square MQIm$) as a measure of the morphological enhancement due to restoration, because MQIm is more sensitive to the effects of the interventions.

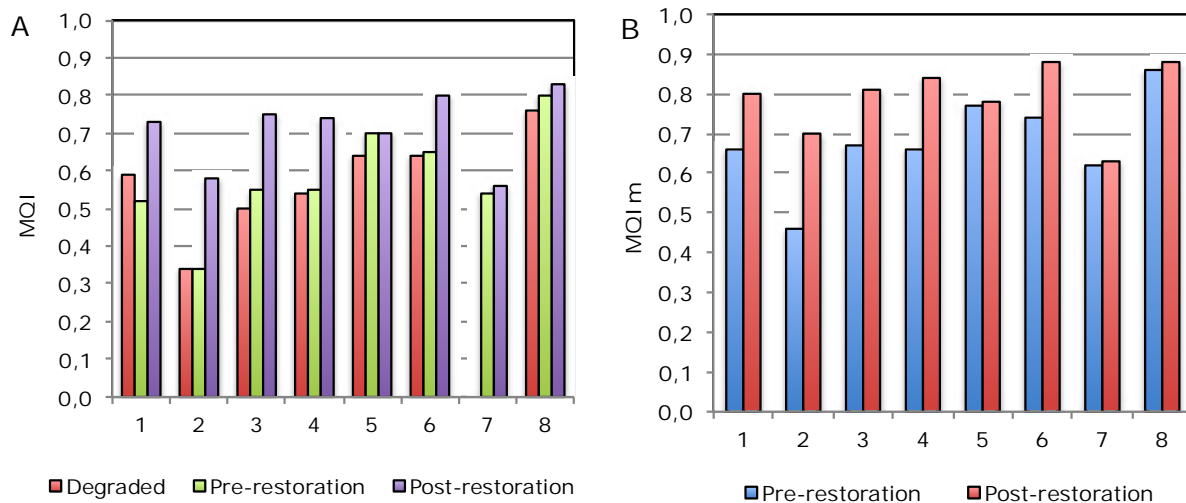

Figure 1. Summary of results. A: MQI for degraded, before restoration, and after restoration conditions. B: MQIm before and after restoration. 1: Aurino; 2: Becva; 3: Drau; 4: Lippe; 5: Narew; 6: Thur; 7: Töss ; 8 : Vääräjoki.

Preliminary discussion and remarks

The varying response of morphological quality ($\square MQIm$) related to restoration may depend on a number of factors, which are divided into two broad groups and discussed as follows.

(1) Initial morphological conditions

Initial morphological quality may have some influence on the increment of quality that is possible to achieve. This aspect is analysed in Figure 2, where the initial morphological quality is expressed by the pre-restoration MQI, and the degree of improvement by Δ MQIm. The trend line does not have a statistical significance but is used to visualise the overall trend. It is evident that the degree of improvement drastically decreases with increasing initial morphological quality, i.e., the benefit of the restoration is very low when the initial quality is already high. The Becva (2) is the river with the lowest initial MQI and the highest increase of morphological quality. The Töss (7) is clearly out of this trend, i.e. the increment of quality is extremely low although the initial MQI is relatively low. This is mainly related to the spatial scale of the intervention (see later). Figure 2 also suggests that channel morphology does not have a significant influence on restoration response, probably because other factors (e.g., initial morphological quality and restored length) are more relevant.

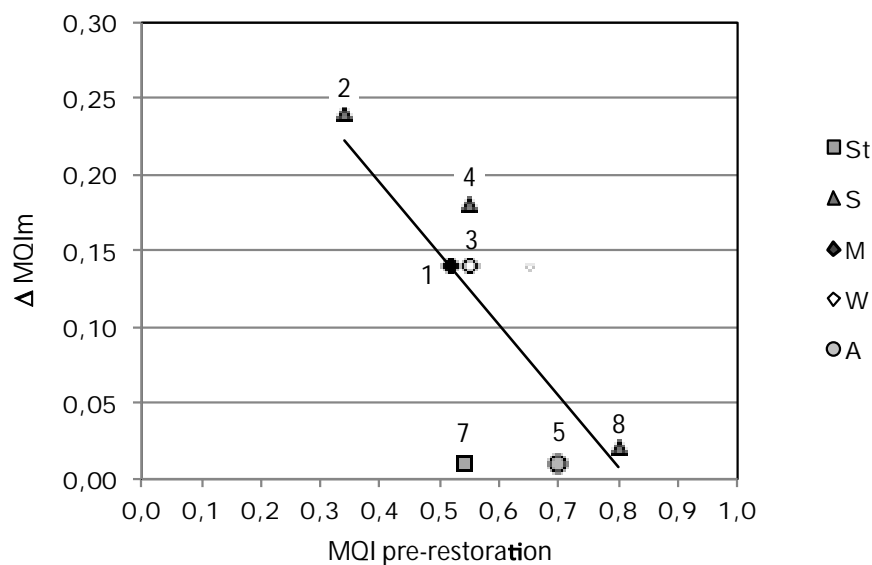

Figure 2. Increment of MQIm (Δ MQIm) vs. initial morphological quality (MQI pre-restoration) for different channel morphologies. 1: Aurino; 2: Becva; 3: Drau; 4: Lippe; 5: Narew; 6: Thur; 7: Töss; 8: Vääräjoki.

Restoration interventions

A second aspect considered here is the restoration intervention, in terms of spatial scale and type of measures. Concerning the spatial scale, Figure 3 plots the increment of MQIm as function of the restored length (%). As expected, the overall tendency (trend line) shows that the enhancement in morphological quality increases with the percentage of restored length. Along this trend line, the negligible increment of morphological quality for the Töss (7), the Vääräjoki (8), and the Narew (5) is clearly explained by the small percentage of the restored site when compared to the total reach length. Conversely, the Lippe (4), Thur (6), Drau (3) and Aurino (1) show a significant increase in morphological quality in relation to a high percentage of restored length. A notable exception from this trend line, which clearly appear as outlier, is the Becva (2), which is characterised by the highest increment in morphological quality but with a low percentage of restored reach. Concerning the influence of the type of restoration measure on the morphological quality increment, the data available are clearly rather limited to enable a conclusion to be reached. However, our analysis showed that removal of bank protection and widening appear to be the most effective types of measures (except for the Töss where the length

of removed bank protections is too limited), while secondary channels and instream measures for habitat enhancement produce limited effects when performed solely. This is not surprising, given that the removal of bank protections and widening directly affects processes, enhance lateral continuity and channel pattern, while secondary channels and instream measures have limited (or no) effects on processes.

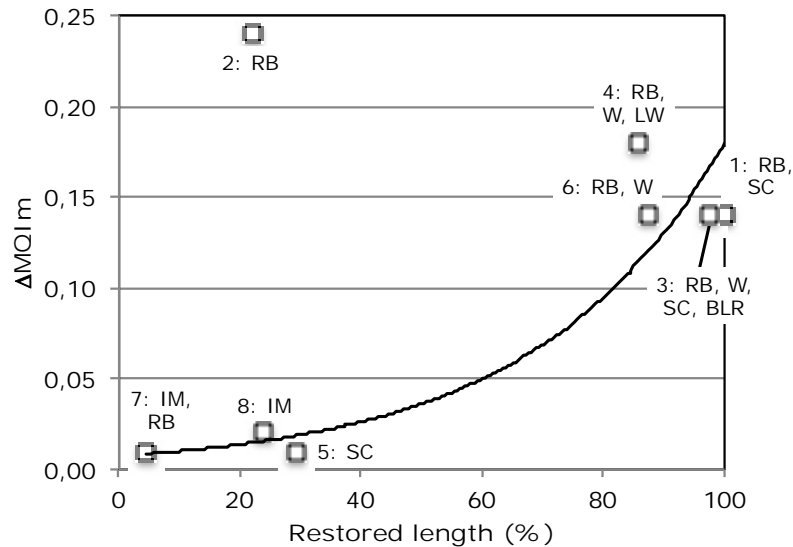

Figure 3. Increment of MQI m (\square MQI m) vs. restored length. 1: Aurino; 2: Becva; 3: Drau; 4: Lippe; 5: Narew; 6: Thur; 7: Töss ; 8 : Vääräjoki. Restoration measures: RB: removal of bank protections and/or artificial levées; W: channel widening; SC: reconnection or construction of secondary channels; BLR: bed level raising; IM: instream measures for habitat enhancement; LW: introduction of large wood.

Some preliminary conclusions based on the previous discussion can be outlined as follows.

- (1) A significant increment of morphological quality is unlikely to be obtained by restoring river reaches already in good condition. For such cases, actions at preserving current conditions should be preferred to restoration interventions.
- (2) Sensitivity of channel morphologies is an important parameter to be considered when interventions aimed at improving hydromorphological quality are planned. An increase of morphological quality is more difficult to obtain in low sensitive morphologies, particularly in the case of measures supporting morphological changes.
- (3) Site scale interventions generally have little effect on hydromorphological conditions when considered on a scale meaningful for morphological processes (reach-scale).
- (4) Measures promoting the recovery of natural processes, such as the removal of bank protection and widening, are more effective than measures recreating forms.

Acknowledgements

The work leading to this paper has received funding for the EU's FP7 under Grant Agreement No. 282656 (REFORM).

References

Gurnell, A.M., Bussetini, M., Camenen, B., González Del Tánago, M., Grabowski, R.C., Hendriks, D., Henshaw, A., Latapie, A., Rinaldi, M., Surian, N., 2014. A multi-scale framework and indicators of hydromorphological processes and forms. Deliverable 2.1, Part 1, of REFORM

(REstoring rivers FOR effective catchment Management), a Collaborative project (large-scale integrating project) funded by the European Commission within the 7th Framework Programme under Grant Agreement 282656.

Kail, J., Lorenz, A., Hering, D. (Eds), 2014. Effects of large- and small-scale river restoration on hydromorphology and ecology. Deliverable 4.3 of REFORM (REstoring rivers FOR effective catchment Management), a Collaborative project (large-scale integrating project) funded by the European Commission within the 7th Framework Programme under Grant Agreement 282656.

Rinaldi, M., Surian, N., Comiti, F., Bussettini, M., 2013. A method for the assessment and analysis of the hydromorphological condition of Italian streams: the Morphological Quality Index (MQI). *Geomorphology*, 180-181, 96-108.

Rinaldi, M., Belletti, B., Bussettini, M., Comiti, F., Golfieri, B., Lastoria, B., Nardi, L., Surian, N., 2015. New tools for an integrated hydromorphological assessment of European streams. *Proceedings REFORM Conference 2015 (this volume)*.

Process based classification of sediment connectivity at the river basin scale

Schmitt R, Bizzi S & Castelletti A

RAFAEL SCHMITT¹, SIMONE BIZZI² & ANDREA CASTELLETTI³

¹*Dip. di Elettronica, Informazione e Bioingegneria, Politecnico di Milano, Piazza Leonardo da Vinci 32, Milan, 20133, Italy. Rafaeljan.schmitt@polimi.it*

²*Institute for Environment and Sustainability (IES), Water Resources Unit (Unit H.01), DG*

³*Joint Research Centre, Via E. Fermi 2749, Building 100, Ispra, 21027, Italy.*

Dip. di Elettronica, Informazione e Bioingegneria, Politecnico di Milano

Novel modelling approaches allow to trace the fate of sediment contributions from individual river reaches throughout the river network and to assess the resulting sediment connectivity at the basin scale. The derived information is an unprecedented source of information to assess from where and over which times a downstream river reach recruits its sediment. This information links strongly to the reach sensitivity to anthropic disturbance or restoration efforts. In this paper, we demonstrate how to make the complex data-sets resulting from basin scale connectivity models accessible for river basin management applications. We introduce the concept of "connectivity signatures" that epitomizes the timing, magnitude, and quality (grain size) domain of connectivity at the reach scale. We use data driven classification techniques to identify a reduced set of typical connectivity classes. Spatial distribution of connectivity classes reveals that these classes represent specific, functional "connectivity styles" with specific locations and functions for sediment routing in the river network. Results concretize the interpretation of sediment connectivity from an operational perspective and open the way for its application to large river basins.

Introduction

Sediment connectivity is a central driver behind fluvial processes. Here, sediment connectivity refers to transfer processes of sediment between sources and sinks through river networks, from initial mobilization, intermediate storage and remobilization, to the final deposition. Hence it embalms both a topologic relationship and the potential mass exchange between any two points in a river network. Accordingly, connectivity represents a framework for integrated assessments of sediment transfers in river basins (1). Sediment transfer processes are increasingly altered by human pressures in most river basins (2) in terms of magnitude, timing, and granulometry, resulting in negative downstream externalities. Understanding how sediment transfers operate at the basin scale is imperative for river basin management in order to understand how river channels and fluvial processes will react to past and future disturbances or restoration options (3).

Our ability to represent the complexity of fluvial sediment transfer processes is limited. Limitations arise from lack of data and limited conceptual understanding of processes and their spatial distribution through the river basin (4, 5). So far, several general frameworks have been proposed to classify river response to sedimentologic disconnection (6, 7). Yet, numerical models suitable to cover relevant spatio-temporal scales and to derive management oriented indicators of sediment - and especially bed-

load - connectivity were absent until recently. In a previous study (8) we contributed a novel modelling environment for detailed assessments of bed-load movement through large river basins. The model is based on the integration of common sediment transport formulas into an effective, graph theoretic representation, and traces the fate of each sediment fraction separately. Hence, it allows to consider preferential transport processes due to heterogeneous grain size mixtures and to assess the impact of such processes on basin scale patterns of sediment transfer. It explicitly identifies multiple sources of sediment supply for each reach, and quantifies the magnitude, timing, and grain size supplied from each of these sources. While the resulting information is of potentially high operational value at the reach scale, its assessment at the larger basin scale is hindered by its complexity and multidimensionality. Here, we aim to reduce the resulting data set's complexity in order to identify common classes of connectivity, for a still process-related, but more generic understanding of connectivity. We apply a data-mining technique to identify if there are groups of reaches that have common connectivity attributes, and evaluate if the derived classification links to spatial distribution and function of the reaches.

Method

The calculation of sediment transfers is based on a recently proposed multi-cascade sediment model (8). In this model, each reach is considered the beginning of a distinct sediment cascade (subscript i). Each sediment cascade is assigned a characteristic grain size d_i that reflects the hydrologic forcing and morphologic conditions in its initial reach. Required data are mainly derived from remote sensing products and some at-station hydrologic data. Sediment cascades are represented as spanning trees (9, 10) that allow to efficiently trace transport processes along each cascade. Sediment transport capacity, Q_s , in each reach along a sediment cascade (subscript j) is calculated with well-established sediment transport formulas (11, 12). Parameterization of transport formulas is based on the same data sources used for calculating d_i . Sediment transport capacity $Q_{s,i}^j$ is reduced to $Q_{s,i}^{j'}$ to consider for the presence of multiple sediment cascades in a reach, and for the competition between these cascades. The reduction factor F_i^j is derived from a dynamic competition function that considers both sediment supply and local transport limitations (8). A reach-to-reach sediment mass balance is calculated along the cascades based on $Q_{s,i}^{j'}$, resulting finally in sediment fluxes along each sediment cascade. If more than 99% of initial sediment inputs are deposited or local energy is not sufficient to transport d_i , a sediment cascade is interrupted. Such a model has been shown to very well represent bulk bed-load fluxes in large river basins (8). The resulting data-set is a comprehensive source of information for basin scale bed-load assessments: any reach receives sediment inputs from multiple cascades, with each cascade conveying information on sediment flux, travel time, and delivered grain size. The information on these three domains of sediment connectivity result in a reach-scale connectivity signature for all reaches in the basin. To conclude, a single sediment cascades carries all information for the travel of sediment from a distinct reach through the fluvial network. The information of all cascades passing through any reach allows, in turn, to identify where this reach's sediment inputs originate and with which connection time and magnitude they are delivered.

In this paper, we present how this data-set can be aggregated into connectivity indicators. Bracken, et al. (1) proposed that connectivity of a river reach to the

downstream river network conceptually maps into a 2 dimensional space that covers the downstream travel distance of sediment, and the sediment load it contributes to the river network. Mapping observations into this phase diagram could help to identify reaches where connectivity is controlled either by detachment or by transport capacity. We start from this notion, but modify and expand it into a management-focused connectivity space. We inverted the direction of analysis from downstream to upstream to analyze how a reach will respond to a change in the upstream fluvial network rather than how it is connected to the downstream fluvial network. We propose to expand the phase diagram by a third dimension, to consider also grain size. Travel distance is replaced by travel time. Hence, the connectivity is described by the indicator in terms of flux, grain size composition, and connection times. Observations are plotted into the 3 dimensional phase diagram spanned by the aforementioned parameters. The connectivity indicator was derived by an unsupervised *k-means* clustering that identified reaches with common characteristics within the 3-dimensional phase space. In order to understand the function of connectivity classes we compare their distribution in the phase space with their spatial distribution throughout the river network.

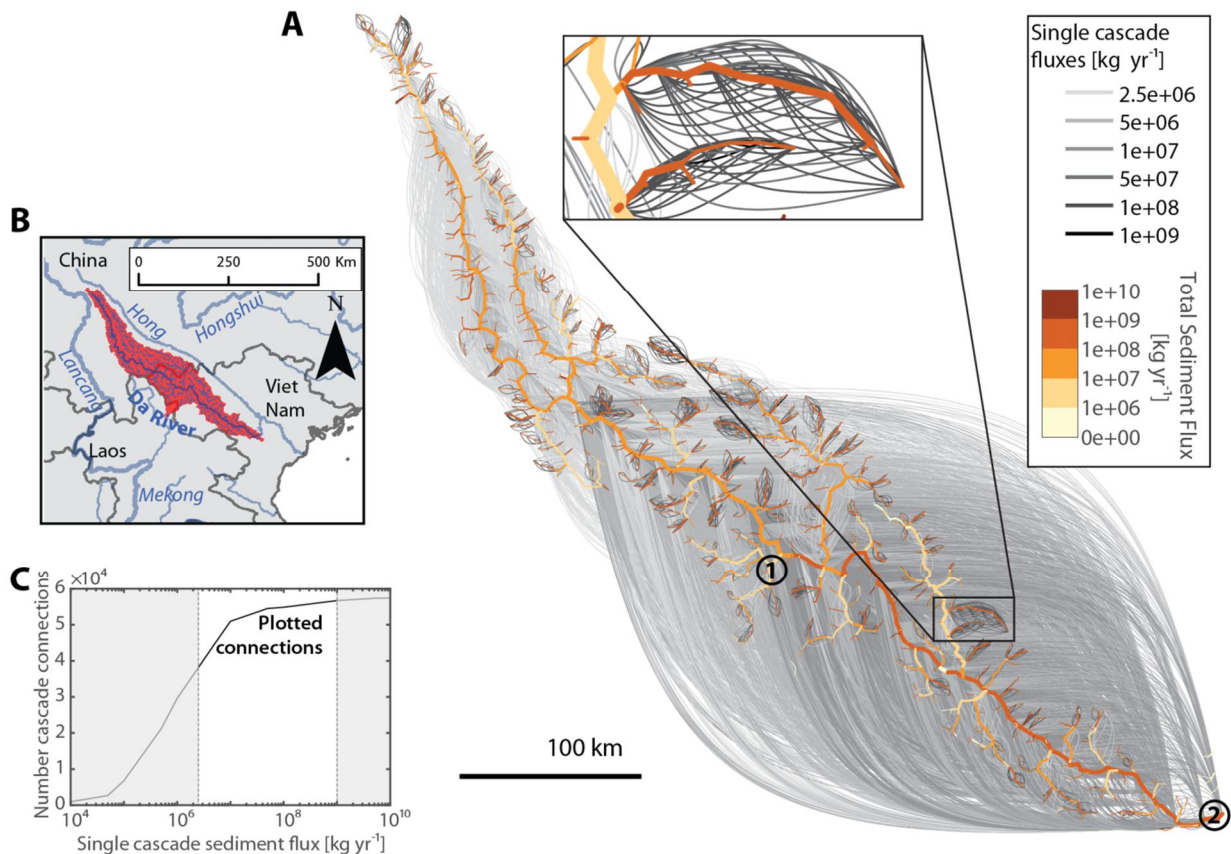

Figure 1. The novel, cascade wise approach to sediment connectivity (Panel A). Grey, curved lines indicate the flux along individual sediment cascades, the red color code indicates the resulting bulk flux in reach. The cutout illustrates the functioning more in detail. Numbers refer to reaches for which connectivity signatures are plotted in Figure Figure 2. Panel B puts the basin into its geographic context. Panel C indicates that only a small number of all connections is plotted here.

Results

We selected the Da River Basin in SE Asia as suitable case study because of its heterogeneity in terms of topography, high sediment production, and the availability of validated hydro-morphologic remote-sensing data sets (13). The total length of the fluvial network included into the modelling is 7400 km, or 2123 reaches. Figure 1 depicts the results of the sediment cascade model for the river system under study that contains 2123 reaches, resulting in the same number of sediment cascades. The model identifies the flux between any pair of reaches connected by a sediment cascade, considering a total of 56472 connections (Panel A, curved lines), each line convey information on the flux delivered along that cascade. The cutout illustrates that each reach receives sediment contributions from multiple upstream reach, and contributes itself to multiple downstream reaches.

Aggregating all sediment fluxes passing through a reach allows defining the total sediment flux in that reach. Each cascade has a specific grain size assigned to it, which allows, together with the sediment flux information, to calculate a mass-weighted median grain size (d_{50}) of the expected sediment mixture in each reach. The available information on the reach scale is presented in Figure 2 for two examples: the terminal reach of a mountainous tributary system and for the basin outlet.

The characteristics of both reaches show up in the presented signatures. Reach 1, which is a gravel bed reach, receives the highest number of sediment contributions and around 80 % of its sediment inputs from cascades with relatively small grain sizes ($d_i < 5\text{mm}$). The connection time of these cascades is relatively fast. The remaining local sediment signature is controlled by cascades that contribute medium gravel ($d_i > 10\text{ mm}$). For these contributions, the connection time is relatively long. For reach 2, a sandy river, the majority of sediment is contributed within relatively short connection times ($< 100\text{yr}$). Here, smaller grain size ($d_i < 1.3\text{ mm}$) are contributed with longer connection times. This indicates that these fines are derived from more upstream parts of the river network. This examples clarify the type of information that can be derived from the full, basin scale data set for individual reaches (Figure 1). The information contained in the connectivity signatures maps well into a connectivity phase diagram that represents grain size, sediment flux, and connection time (Figure 3, Panel A). End members of the phase diagram are reaches with (i) high fluxes and low connection times, (ii) high sediment fluxes but long connection times (iii) low fluxes but high connection times, and (iv) low fluxes but fast connection times. An unsupervised clustering technique identified 7 typical connectivity classes. A spatial analysis indicates that these classes have a characteristic spatial distribution within the river network. Class 1-3, for example, represents headwater reaches, class 4 intermediate reaches, and class 5 and 6 major tributaries and the main stem (Figure 3, Panel B). This clear spatial sequence of classes allows deriving a functional trajectory of sediment connectivity from up- to downstream (Figure 3, Panel C). This trajectory coincides very well with the conceptual understanding of sediment connectivity, and allows understanding the dominant processes in each class. Classes 1-3 are driven by increasing sediment flux production. Class 4, with increasing connection times and decreasing fluxes is dominated by the routing and storage of upstream sediment. Class 5 and 6 see an increase in fluxes and also connection times: dominant process include the concentration and routing of the incoming fluxes.

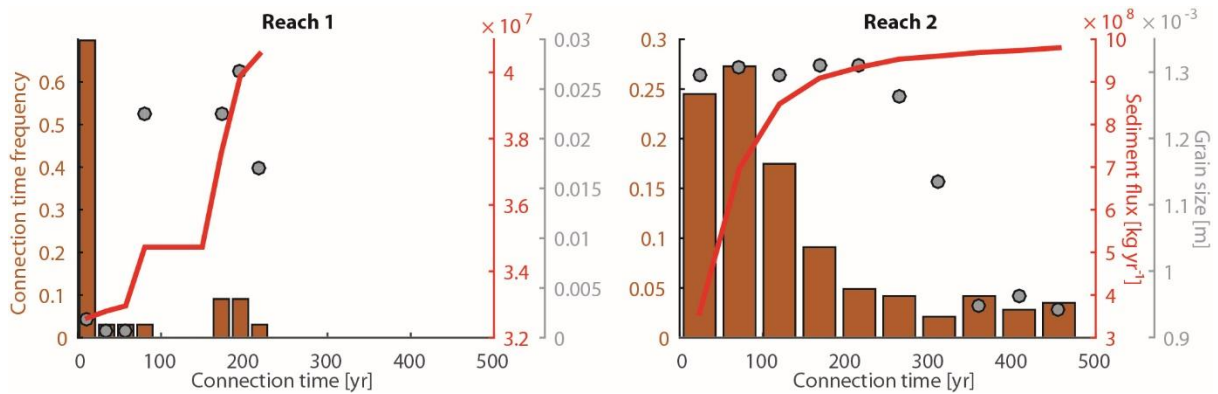

Figure 2. Connectivity signatures (grain size, connection times, sediment flux) for two selected reaches for a mountainous (reach 1), respectively a low land river (reach 2), see Figure 1 for exact location.

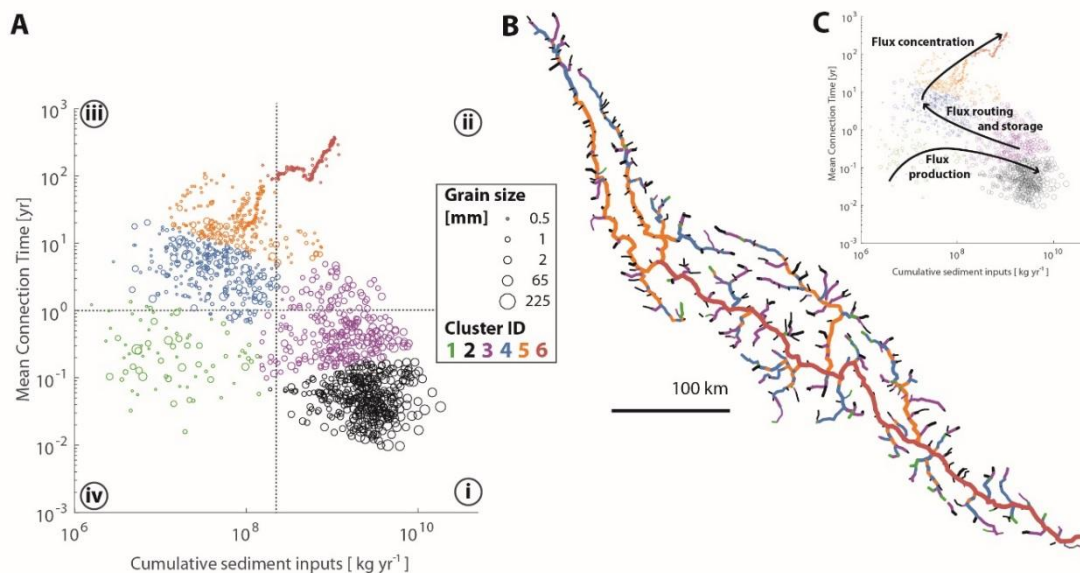

Figure 3. Definition of connectivity classes based on model results. Connectivity properties of all reaches are mapped into the phase space proposed by (1) and divided into typical classes by unsupervised data-mining (Panel A). Panel B indicates the geographic position of members of each class. Panel C presents a functional classification based on results shown in Panel A and B.

Discussion and conclusion

Results of the multi-cascade sediment model provide a relevant source of information on sediment transport processes that is for the first time available in this detail over the presented scales. The model adopts a scale spanning perspective and considers cross-interactions over scales. It produces detailed sedimentologic information in terms of sediment fluxes, connection times, grain sizes, and sediment source areas. We presented how this local information can be successfully classified into broader classes using data-driven approaches. Classes map well into previously proposed categories of connectivity (1). So far, it was not known how these conceptual classes map spatially throughout a river network, or if they fulfill specific functions in basin scale sediment transport. Based on the spatial distribution of class-members, we can clarify the function of these

categories in general, and for the river basin under study. "Connectivity styles" discern river reaches with a well-defined position in the network, with specific functions, and driving forces. We propose, that "connectivity styles", and local connectivity signatures are of concrete management interest to assess reach scale reaction to anthropic alterations in sediment connectivity or restoration action.

References

- Bracken LJ, Turnbull L, Wainwright J, Bogaart P (2014) Sediment connectivity: a framework for understanding sediment transfer at multiple scales. *Earth Surf Process Landforms*: n/a–n/a.
- Syvitski JPM, et al. (2005) Impact of Humans on the Flux of Terrestrial Sediment to the Global Coastal Ocean. *Science* 308(5720): 376–380.
- Owens PN, et al. (2005) Fine-grained sediment in river systems: environmental significance and management issues. *River Research and Applications* 21(7):693–717.
- Merritt WS, Letcher RA, Jakeman AJ (2003) A review of erosion and sediment transport models. *Environmental Modelling & Software* 18(8–9):761–799.
- Prosser IP, et al. (2001) Large-scale patterns of erosion and sediment transport in river networks, with examples from Australia. *Mar Freshwater Res* 52(1):81–99.
- Brandt SA (2000) Classification of geomorphological effects downstream of dams. *Catena* 40(4):375–401.
- Grant GE, Schmidt JC, Lewis SL (2003) A geological framework for interpreting downstream effects of dams on rivers. *A peculiar river*:203–219.
- Schmitt R, Bizzi S, Castelletti A (2015) Multi-cascade sediment modeling for basin-scale connectivity assessments. *In preparation*.
- Czuba JA, Fofoula-Georgiou E (2015) Dynamic connectivity in a fluvial network for identifying hotspots of geomorphic change. *Water Resour Res*: n/a–n/a.
- Czuba JA, Fofoula-Georgiou E (2014) A network-based framework for identifying potential synchronizations and amplifications of sediment delivery in river basins. *Water Resources Research* 50(5): 3826–3851.
- Engelund F, Hansen E (1967) *A monograph on sediment transport in alluvial streams* (TEKNISKFORLAG Skelbreggade 4 Copenhagen V, Denmark.)
- Wong M, Parker G (2006) Reanalysis and Correction of Bed-Load Relation of Meyer-Peter and Müller Using Their Own Database. *Journal of Hydraulic Engineering* 132(11):1159–1168.
- Schmitt R, Bizzi S, Castelletti A (2013) Characterizing drivers of hydromorphology by Data Mining techniques (Vienna).

Restoration of a river system in an urban area: towards the Good Ecological Potential of former sewage channels

Winking C, Lorenz A & Hering D

CAROLINE WINKING, ARMIN LORENZ & DANIEL HERING

University of Duisburg-Essen, Department of Aquatic Ecology, Universitätsstr.4, 45141 Essen, Germany.

Abstract

1. The Emscher stream system was used as the sewage drainage system in the large industrial area of the "Ruhr Metropolitan Area" in western Germany. Large parts of the Emscher and its tributaries have been used as open sewers since over 100 years. With the end of coal mining and related subsidence, the wastewater is discharged into underground sewers and streams are restored.

2. As a result, aquatic communities are recolonising the restored streams in the Emscher catchment. Based on 248 taxa lists of benthic invertebrates sampled in restored sites, our analysis focused on the "Ecological Potential" according to the Water Framework Directive, as the streams are classified as "heavily modified water bodies". As possible explanatory parameters for the Ecological Potential we included, amongst others, riparian land use, river habitats, and time since restoration into a PCA analysis.

3. Almost 40 % of the sites already achieve the "Good Ecological Potential". Environmental parameters enhancing the probability of meeting the Good Ecological Potential include: connection of restored sites to an unmodified stream stretch, dead wood in the stream bed, good hydro-morphological structure, deciduous riparian vegetation and unsealed surface in the stream's vicinity, while the occurrence of iron ochre in the restored sections and sewage overflows located upstream of sampling sites impede the achievement of the Good Ecological Potential.

4. From the results suggestions for further optimisation of urban stream restoration are derived: supporting wood riparian vegetation, monitoring of sewage overflows, connection to near-natural tributaries, and active addition of dead wood.

Introduction

Urban streams differ in many ways from streams and rivers in the open countryside: their lateral development is limited due to roads and buildings, their hydro-morphology and water quality are affected by a variety of stressors and often long stretches are piped so that the remaining stretches are isolated (Bernardt & Palmer, 2007). All this has repercussions on the benthic assemblages that are mostly degraded and characterised by missing stress-sensitive species (Coles et al., 2012).

In Europe, according to the Water Framework Directive (WFD) urban streams are often classified as "heavily modified water bodies" (HMWB). These water bodies are subject to stream-specific anthropogenic pressures, which cannot be removed due to high social or economic costs. Therefore, the "Good Ecological Status", the ambitious objective of the WFD, is usually not attainable and replaced by the "Good Ecological Potential" as a management goal.

The Emscher-catchment is a prototype for urban streams and rivers. The watershed is located in the Ruhr Metropolitan Area (western Germany) with more than 5 million inhabitants. Even compared to other urban regions most streams of the Emscher network are unusually degraded: laid in concrete channels, they served as open sewers for about 100 years and transported the wastewater of the region. Due to the mining-induced subsidence of the surface it was, for a long time, not possible to build underground sewers. The Emscher and the downstream sections of its tributaries have therefore been used as above-ground sewers of a total length of about 350 km. Furthermore, the soils of the Ruhr Metropolitan area are frequently contaminated, which can affect the streams with pollutants of all kinds. Road wastewater, storm water overflows and discharge buildings also contribute to a complex stress situation.

Since the coal mining came to an end and subsidence are not expected anymore, the regional water board, the Emschergenossenschaft, has started to restore the Emscher and its tributaries with the aim to reach the "Good Ecological Potential". Underground sewers were built to transport the wastewater, the concrete shells were removed, and the stream beds and the riparian areas were restored. The total investment amounts to 4.5 billion €. Until now, about 123 km (status of December 2014) of the total of 350 km have already been restored (EGLV, 2015).

Contrary to other stream restoration projects, no higher organisms occurred in the restored former sewage channels; for decades only Oligochaeta endured the wastewater (Winking et al., 2014). Thus, an entirely novel benthic invertebrate community developed in the new streams, which may, however still be inhibited by water pollution and anthropogenic barriers. Similarly to other restored rivers sections, pressures acting at larger spatial scales might shape the benthic assemblages more strongly as compared to pressures acting at the site scale (Kail & Wolter, 2013). In other studies, however, site scale pressures are described of equal influence for the assemblages than those acting at the catchment scale (e.g. Verdonschot, 2009). Additionally, Lorenz & Feld, (2013) described the hydro-morphological status of the adjacent upstream river network as an important factor influencing the benthic assemblages and the ecological status of restored streams. In summary, the environmental parameters that affect benthic invertebrate assemblages are not fully understood and it is unclear which are most relevant for the development of restored urban streams.

In the present study, we investigated the Ecological Potential of restored streams in the Emscher catchment. We particularly addressed the three following questions:

- What is the Ecological Status of the restored streams in the Emscher catchment?
- Which environmental parameters influence the Ecological Potential of the restored streams?
- Which recommendations arise for future restoration projects of the Emscher watershed and of urban streams in general?

Methods

The data basis of our analyses were benthic invertebrates' taxa lists of restored sites of the Emscher catchment. Samples from the years 1994 to 2013 were considered, which resulted in 248 taxa lists from 48 sampling sites in 13 streams.

The samples were taken in the spring season either taken according to the German standard multi-habitat sampling protocol or according to the less specifically described method according to DIN 38410. The Ecological Potential (EP) of the 248 taxa lists was calculated with the software PERLODES (ASTERICS software, version 4.03). The HMWB - type "Flood Protection and Urbanisation (with foreland)" was used.

For each sample 87 environmental parameters were collected, thereunder time since restoration (years) at time of sampling, presence of iron ochre (yes/no), the share of microhabitats on the river bed (stones and gravel, sand and clay, artificial substrates, algae and macrophytes and living parts of terrestrial plants, organic matter, dead wood); or to the site: length of the restored section (m), occurrence of sewage overflows upstream of a sampling site (yes/no), and connection to a near-natural upstream stretch or tributary (yes/no). Three environmental parameters concern the physical habitat quality (PHQ) of the sampling sites and the section upstream of the sampling sites (mean score of the stretches 200 m upstream and 1000 m upstream).

ATKIS®-Data (spatial resolution 3 m) was used to evaluate the share of land use in the sub-catchment and in riparian buffers. Based on the results of Kail & Hering (2009), the buffer lengths were set to 100 m 200 m, 500 m and 1000 m, with widths of 20 m and 100 m. Finally, the share of land use and sealed surface were calculated within these buffer areas and sub-catchments. In addition, the share of contaminated areas within the sub-catchments was derived from GIS-data.

To analyse the influence of environmental parameters on the Ecological Potential non-metric multidimensional scaling (NMS) with the assemblages of all samples was carried out. NMS was based on the Bray-Curtis similarity index with $\log x+1$ transformed abundance data. Principal Components Analysis (PCA) was applied to elaborate the relation of the Ecological Potential to the environmental parameters and to rate the relative importance of environmental parameters for the Ecological Potential. The PCA included all 87 environmental parameters and all samples ($n = 248$).

Results

About 44% of all 248 samples indicate a "good" or "very good" Ecological Potential (Figure.1). 17 of the 48 sampling sites (35.4%) have already reached the Good Ecological Potential at the most recent sampling. The assemblages of sampling sites with a Good Ecological Potential differed significantly from the assemblages with a poor or bad Ecological Potential (ANOSIM at $R > 0.5$ and a $p < 5\%$; Fig. 2.1). Although the sampling sites at which the Good Ecological Potential was reached were mainly located in stream sections that have been restored nine or more years ago (Figure 2.1 and 2.2.), no significant difference was found between sites that have been restored more or less than 9 years before (ANOSIM at $R = 0.26$ and a $p < 5\%$). There was no significant difference in Ecological Potential between stream types and sampling method (Fig. 2.3 and 2.4). The PCA calculated with all 248 samples revealed the "age of restoration" as the most important parameter influencing the Ecological Potential, followed by "unsealed area in the buffer of 100 x 1000 m", while the "presence of iron ochre" was negatively correlated (Fig. 3).

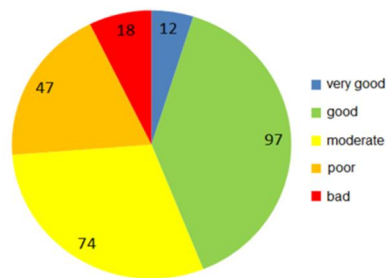

Figure 1 Ecological Potential of all samples (n = 248) assessed by HMWB-Type: "Flood Protection and Urbanisation (with foreland)".

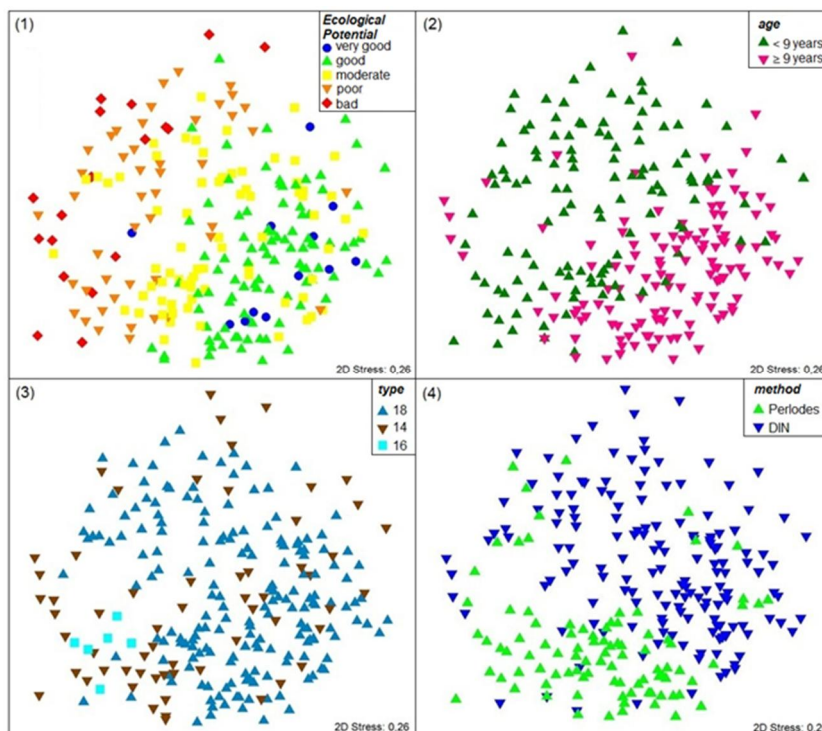

Figure 2 Non-metric multidimensional scaling (NMS) of 248 benthic invertebrate assemblages coloured according to (1) Ecological Potential, (2) age of restoration, (3) stream type and (4) sampling method: Perlodes = Multi-Habitat-Sampling, DIN = DIN 38410.

Discussion

The dominant factor for reaching the Good Ecological Potential in streams of the Emscher catchment seems to be the time since restoration. The recolonisation by sensitive taxa, which are key indicators for a Good Ecological Potential, is related to their dispersal capability, to the recolonisation sources, the in-stream and riparian habitats of the restored streams, and the habitat quality at the catchment scale (e.g., Sundermann et al., 2011), whereas the last parameter need time to develop. The development of the assemblages and the Ecological Potential of the sites vary greatly. In part, adjacent sampling sites differ significantly within a water body. A reason may be that e.g., the environmental conditions may change between nearby sections. This may explain why assemblages of some sites develop faster than others. Persisting water quality problems or missing habitat structures may explain why some sites have not yet reached the Good Ecological Potential, even after several years, or have even deteriorated. Hence, it is not

just a matter of having patience to reach the Good Ecological Potential. The age of restoration, is a spurious correlation and can be interpreted as a proxy for the degree of the habitat development of the stream. This is underlined by the fact that three environmental parameters, which show a positive development of habitats (deciduous shrubs, dead wood, and the PHQ) are positively correlating with the age of restoration. The presence of sewage overflows, which can hinder a positive development of in-stream habitats, is correlating negatively with the age of restoration. Maturation of the communities and attaining the Good Ecological Potential requires shorter time spans, if positively influencing environmental parameters are present shortly after restoration. The Good Ecological Potential can then be reached after 1 or 2 years after restoration, but is also observed to need about a decade. Both is surprisingly short for these virgin streams, as other studies found mean recovery times in restored freshwaters of 10 to 20 years. This fits to our results, as deciduous shrubs, a good hydro-morphological quality and dead wood on the streambed indicate the degree of maturation of the restored site. The connection to a near-natural stretch also plays a key role for the recolonisation with sensitive taxa, hololimnic taxa and taxa with a low dispersal capability (Parkyn & Smith 2011). This connection is particularly important for the primary colonisation by drifting species. The positive effect of unsealed area in the surroundings of the restored streams was also evident. Unsealed soil acts as a buffer for inputs of matters and reduces diffuse pollution. A high share of unsealed area in the surroundings (buffer of 20x1000m, or 100x1000m) has thereby a stronger effect on the Ecological Potential than the unsealed area in the sub-catchment; a result that was also found in the study of Lorenz & Feld (2013).

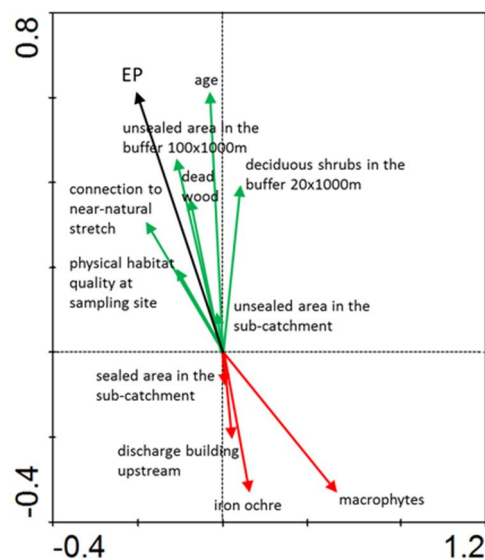

Figure 3 PCA of environmental parameters and the Ecological Potential (EP) calculated with all samples (n = 248).

In contrast, iron ochre on the stream bottom affects the Ecological Potential negatively. The clogging of substrates and the bonding of gills affect many macroinvertebrate species. Sewage overflows that temporarily impair water quality primarily influence the assemblage of older restored sections, where riparian vegetation and in-stream habitats have developed and sensitive taxa have already recolonised.

Surprisingly, the presence of macrophytes is negatively correlated with the Ecological Potential. Macrophytes provide habitat and food for other aquatic organisms, increase the structure- and flow diversity, contribute to the bottom and bank stabilisation and have diverse effects on the water chemistry, such as absorption of nutrients and heavy metals, and delivery of oxygen. In our results, the negative relation to the Ecological Potential probably reflects the age of restoration, hence the maturation of the stretch: Young, nutrient-rich, still unshaded stretches have optimal conditions for macrophytes.

The following recommendations can be derived from our results to optimise future restoration projects: Creation / promotion of growth of deciduous shrubs along buffer strips of the streams, monitoring of discharge buildings, provision of connection to tributaries, and active addition of dead wood to the streams.

The results are best transferable within the Emscher system and for other streams of the HMBW type "Flood Protection and Urbanisation (with foreland)". Future restoration projects in streams with environmental parameters as the streams meeting a Good Ecological Potential have likewise chances to achieve the Good Ecological Potential. Orientation values, as a means of the sampling sites ($n = 248$) which already achieved the Good Ecological Potential, are:

- Minimum share of deciduous riparian vegetation in the buffer of 20x1000m: 60 %
- Minimum share of deciduous riparian vegetation in the buffer of 20x500m: 58 %
- Minimum share of unsealed area in the sub-catchment: 60 %
- Minimum share unsealed area in the buffer 100x1000m: 78 %
- Minimum share unsealed area in the buffer 20x1000m: 84 %
- Deadwood present on the stream bottom
- Connection to a near-natural tributary or upstream section
- Iron ochre absent

References

- Bernardt, E.S. & Palmer, M.A. (2007). Restoring streams in an urbanizing world. *Freshwater Biology*, 52: 738–751.
- Coles, J.F., McMahon, G., Bell, A.H., Brown, L.R., Fitzpatrick, F.A., et al. (2012). Effects of urban development on stream ecosystems in nine metropolitan study areas across the United States. *U.S. Geological Survey Circular*. 1373: 138 p.
- EGLV (Emschergenossenschaft/Lippeverband) (2015). Generationenprojekt für eine Region mit Zukunft. Available at: www.eglv.de/wasserportal/emscher-umbau.html.
- Kail, J. & Hering, D. (2009). The influence of adjacent stream reaches on the local ecological status of Central European mountain streams. *River Research and Applications*, 25: 537–550.
- Kail, J. & Wolter, C. (2013). Pressures at larger spatial scales strongly influence the ecological status of heavily modified river water bodies in Germany. *Science of the Total Environment*. 454-455: 40–50.
- Lorenz, A.W. & Feld, C.K. (2013). Upstream river morphology and riparian land use overrule local restoration effects on ecological status assessment. *Hydrobiologia*, 704: 489–501.
- Sundermann, A., Stoll, S. & Haase, P. (2011). River restoration success depends on the species pool of the immediate surroundings. *Ecological Applications*, 21, 1962–1971.
- Parkyn, S.M. & Smith, B.J. (2011). Dispersal constraints for stream invertebrates: Setting realistic timescales for biodiversity restoration. *Environmental Management*, 48: 602–614.
- Verdonschot, P.F.M. (2009). Impact of hydromorphology and spatial scale on macroinvertebrate assemblage composition in streams. *Integrated Environmental Assessment and Management*, 5: 97–109.

Winking, C., Lorenz, A.W., Sures, B. & Hering, D. (2014). Recolonisation patterns of benthic invertebrates: A field investigation of restored former sewage channels. *Freshwater Biology*, 59: 1932–1944.

5. DISCERNING THE IMPACT OF HYDROMORPHOLOGICAL MODIFICATION FROM OTHER STRESSORS

Riparian Plant community responses to increased flooding

Garssen A G et al.

GARSSEN A.G.¹ BAATTRUP-PEDERSEN A.² VOESENEK, L.A.C.J¹. VERHOEVEN, J.T.A¹.
& SOONS M.B¹.

¹*Department of Biology, Utrecht University, Padualaan 8, Utrecht, 3584 CH, the Netherlands.*

²*Department of Bioscience, Aarhus University, Vejlsvøvej 25, P. O. Box 314, DK-8600 Silkeborg, Denmark.*

An increased flooding risk from European streams and rivers has been projected to change riparian plant community composition and species richness, but the extent and direction of the expected shift remain uncertain. We conducted both a meta-analysis and field experiments to synthesise experimental evidence and assess the effects of increased flooding on riparian plant and seedling survival, biomass and species composition. We evaluated which plant traits are of key importance for the response of riparian species to flooding. We identified and analysed papers with quantitative experimental results on flooding treatments and corresponding control situations. Moreover, we conducted a flooding experiment along five North-Western European riparian gradients. Our meta-analysis clearly demonstrated how longer duration of flooding, greater depth of flooding and, particularly, their combination reduce seedling survival of most riparian species. Plant height above the water level, ability to elongate shoots and plasticity in root porosity were decisive for adult plant survival and growth. Our literature survey confirmed that the projected increase in the duration and depth of flooding periods is sufficient to result in species shifts. Nutrient, climatic and hydrological status of the catchment determine the direction of change; species richness was generally reduced at flooded sites in nutrient-rich catchments and at sites that previously experienced relatively stable hydrographs, while it increased at sites in desert and semi-arid climate regions. Our field experiment revealed that a six-week flooding period can already lead to a reduction in riparian species richness.

Introduction

Climate change is projected to increase the magnitude and frequency of intense precipitation events in the near future (IPCC, 2007). These changes will have significant effects on the hydrological interaction between rivers or streams and their riparian zones, with implications for the ecology of both types of ecosystems. In most temperate regions, such as Northern and Central Europe, annual precipitation is expected to increase, particularly in the cold season, resulting in a consistently higher flood risk from streams and rivers in winter (Dankers & Feyen, 2009; Hirabayashi *et al.*, 2013). As riparian ecosystems are (at least partly) rain-fed systems, they are sensitive to precipitation changes (Poff *et al.*, 1997; Garssen *et al.*, 2014), and an increase in flooding frequency can be expected to affect species distribution limits and communities through a series of physical and ecological changes. The depth, frequency, duration and timing of flooding are all decisive for the survival of plant species (Voesenek *et al.*, 2004; van Eck *et al.*, 2004). While many wetland plants can tolerate a saturated soil, a situation

in which plants are partly or fully submerged is more critical for their survival. Plant strategies to tolerate flooding include many physiological adaptations to withstand oxygen and carbon dioxide shortage and mechanical stress. The 'escape strategy', which may include shoot elongation and aerenchyma formation (increased root porosity), permits the plant to regain contact with the atmosphere to improve availability of light, carbon dioxide and oxygen (Laan & Blom, 1990; Bailey-Serres & Voeselek, 2008). On the other hand, the 'quiescence strategy' allows the plant to survive as long as possible under unfavourable conditions, most prominently low oxygen levels, by maintaining low growth rates and the avoidance of high metabolic activity. When plant species are sufficiently adapted to survive flooding, biomass can be sustained or regrowth can take place after withdrawal of the floodwater. However, if species lack these adaptations, a strong reduction of biomass takes place during flooding (van Eck *et al.*, 2004).

Given the multitude and complexity of ecological, physiological and biogeochemical responses to increased flooding in the riparian zone, it is difficult to predict flooding effects on riparian plant communities. Yet, such information is crucial for future management plans dealing with the vegetation and biodiversity of these highly vulnerable ecosystems. We use a systematic literature review, meta-analysis and field experiment to evaluate specifically: (1) the relation between increased flooding and seedling and adult plant survival, (2) the relation between increased flooding and plant biomass, (3) which plant functional traits are most crucial for response success during flooding, and (4) responses in riparian plant species richness to increased flooding.

Methods

For our systematic review and meta-analysis, we searched ISI Web of Knowledge for scientific peer-reviewed studies on the effects of increased flooding on riparian wetland plant survival, above- and belowground biomass and species richness. We selected specific keyword strings for our search and supplemented these with relevant cases from publications selected in an earlier analysis on the effects of drought on riparian plants (Garssen *et al.*, 2014). We only selected data from field studies carried out in riparian wetlands along streams or rivers or from experiments with typical riparian wetland plants. All selected studies had a before-after (BA), control-impact (CI) or a before-after-control-impact (BACI) design in order to be able to quantify the effects of flooding. From the selected literature studies we extracted cases linking a single response variable to a single flooding treatment. We analysed the responses of plant survival and biomass to flooding by calculating response ratios: the ratio of the treatment (impact) to the control group. Our literature search on flooding effects on plant species richness resulted in 23 studies considering the response of riparian plant species richness and species composition to an increase in duration, depth and frequency of flooding. We evaluated the cases in which flooding positively or negatively affected these vegetation characteristics.

Five riparian areas situated in Denmark, Germany and the Netherlands were selected for a flooding experiment. A control and flooding section were chosen comprising similar plant communities. We positioned dam constructions in the streams to be able to create a significantly higher surface water table at the flooding sections, compared to normal winter conditions. In the control sections, stream water tables were not manipulated. The flooding experiment was conducted during three consecutive years (2011 - 2013), and

wetter conditions lasted approximately six weeks in early spring each year. Within each experimental section three transects were selected along the stream-riparian gradient, ranging from the lowest water table of the stream under summer base flow to the furthest point up the stream valley that can be flooded by surface water during extreme winter floods. Along the stream-riparian gradient three sampling points were chosen. We conducted measurements on three different ecological levels: environmental conditions (water tables, water and soil chemistry during flooding), ecosystem functioning (biomass) and plant biodiversity (plant and seed rain diversity and composition).

Results meta-analysis and systematic review

Survival and biomass

Regression analyses show a significant negative effect of flooding duration on seedling and adult plant survival, while no effect of depth on seedling survival was detected. When considering flooding depth relative to plant height, a significant positive linear relationship was found. There is much variation in survival under fully submerged conditions, whereas plants that protrude above the water level (>20 cm) almost all survive. Plant species able to elongate their shoots show no significant relation between survival response and flooding duration, whereas plant species unable to plastically elongate their shoots show declining survival over time. Interestingly, flooding duration had no significant effect on the amount of total biomass. Moreover, at increasing flooding duration, riparian plants appeared to have adjusted their root porosity more strongly. A largely negative effect of increased flooding depth on total biomass of riparian wetland plants was observed. In all cases fully inundated plants suffered severe biomass loss, while plants with leaf parts in the air showed a wide range of responses. Particularly for plant species able to elongate shoots, there is a significant positive relation between relative plant height and the response ratio of biomass.

Survey riparian plant species richness and species composition

A variety of responses and mechanisms related to increased winter or spring flooding were reported, leading to an increase or decrease in species richness. The majority of studies reporting negative effects of flooding on species richness were conducted in the more northern located Atlantic and boreal region (7 out of 9 studies), while most studies reporting positive effects were conducted in the semi-arid or desert region (4 out of 7 studies) where water scarcity plays a role. The negative effects of flooding on species richness were often related to a relatively high nutrient input from the flood water, leading to eutrophication and an increase in the abundance of productive species (4 out of 9 studies). Also, extreme flood events at sites with a normally stable yearly discharge may lead to a reduction in species richness (6 out of 9 studies) (Table 1).

Table 1. Summary of survey, main effects of flooding on riparian plant species richness. For references see online paper: <http://onlinelibrary.wiley.com/doi/10.1111/gcb.12921/abstract>

Main trend	Author	Main effect of increased flooding, mechanisms	Biogeographical region
Decrease species richness (9)	Baatrup-Pedersen <i>et al.</i> , 2013a	Shift towards more productive species, sediment deposition	Atlantic, Denmark
	Baatrup-Pedersen <i>et al.</i> , 2013b	Higher frequency flooding lead to lower diversity, competition	Atlantic, Denmark
	Beltman <i>et al.</i> , 2007	Promotion of highly competitive species, increased biomass	Atlantic, the Netherlands
	Decocq, 2002	Disturbances (stressful environments) resulted in low diversity	Atlantic, Belgium and France
	Petit <i>et al.</i> , 2001	Response riparian vegetation depended on natural flow regime	Semi-arid / Subtrop., Australia
	Renöfalt <i>et al.</i> , 2007	Extreme floods in tranquil reaches lead to higher mortality	Boreal, Sweden N
	Ström <i>et al.</i> , 2011	Flood duration played strong role in shift species composition	Boreal, Sweden N
	Ström <i>et al.</i> , 2012	Flood duration important, reduction of most species-rich belts	Boreal, Sweden N
	Wassen <i>et al.</i> , 2003	Impact hydrology and nutrient release, increase standing crop	Continental, NE Poland
Increase species richness (7)	Baatrup-Pedersen <i>et al.</i> , 2005	Alpha diversity higher along freq. flooded natural streams	Atlantic, Denmark
	Capon, 2005	Flow variability promoted landscape heterogeneity	Arid / Semi-arid, C Australia
	Horner <i>et al.</i> , 2012	Germination flood-dependent species seed bank, native flora	Semi-arid / Mesic, SE Australia
	Hughes & Cass, 1997	Flood-induced disturbance generated highly diverse mosaic	Continental, NE USA
	Jansson <i>et al.</i> , 2005	Flooding increased the number of colonising species, dispersal	Boreal, Sweden N
	Stromberg <i>et al.</i> , 2007	Increase in abundance of pioneer wetland plant species	Desert, S USA
	Stromberg <i>et al.</i> , 2009	Moderate flooding stimulated establishm. opportunistic spec.	Desert, S USA
No sign. difference (2)	Gerard <i>et al.</i> , 2008	Most imported seeds belonged to only a few species	Atlantic, Belgium.
	Toogood & Joyce, 2009	Composition of grassland plant communities responded	Atlantic, SE UK
No results richness, but composition or performance(4)	Johansson & Nilsson, 2002	Reduced performance (growth and survival) in all species	Boreal, Sweden N
	Lyon & Sagers, 1998	Flooding stimulated species replacement	Continental, C USA
	Tabacchi, 1995	Increase in hygrophilous species in oldest arms of river	Atlantic, SW France
	Townsend, 2001	Extremely wet years driven competitive sorting	Subtropical, E USA.

Results field experiment 2011 – 2013

After three years of increased winter flooding, a pronounced overall negative response of riparian species richness on increasing water tables was detected. Linear regression analyses on all cases in the flooding sections show a significant negative relation between water table and species richness ($P=0.003$), while in the control section no relationship is detected ($P=0.536$) (Fig. 1a). In the LMM including all cases, a general negative effect of water table on species richness is found, and a positive interaction between section and

water table. In the flooding section, a strong positive relation between water table and biomass can be detected ($P=0.002$), while in the control section there is no relationship ($P=0.558$) (Fig. 1b). The interaction effect between section and water table on biomass is significant and negative (LMM analysis).

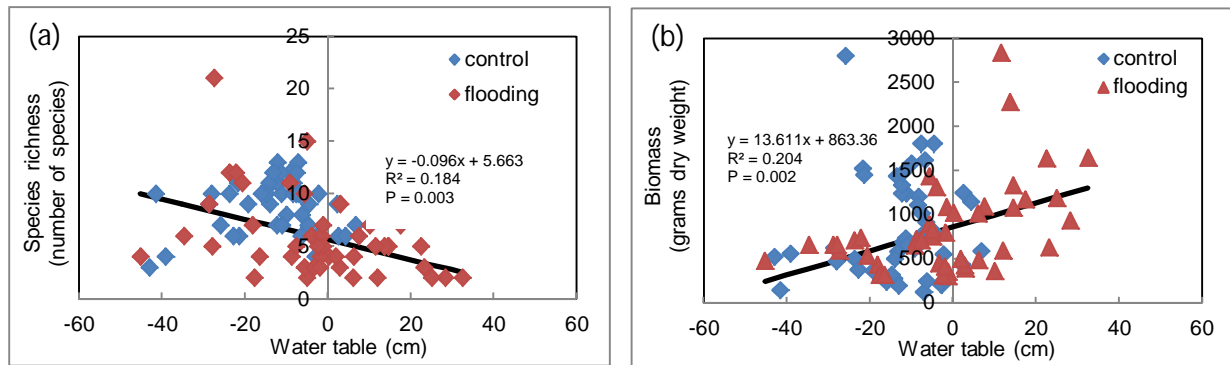

Figure 1. Effects of water table on species richness of the riparian vegetation (a) and aboveground plant biomass (b) in control and flooded plots along the five investigated European lowland streams. A positive water table means the sampling point was inundated. $n = 45$ in control section, $n = 45$ in flooding section. Equations of significant relations are displayed in the graph.

Conclusions & Recommendations

Experimental data under controlled conditions show that longer duration of flooding leads to a greater reduction of seedling and adult riparian plant survival. Interestingly, longer duration of flooding per se does not result in lower riparian plant biomass, as demonstrated by our meta-analysis as well as field experiment. More detailed analyses point out that, across the studies here examined, the reduction in survival exists predominantly in species that do not have the plasticity to elongate their shoots under water. Our meta-analyses unequivocally demonstrate that it is critical to what extent the plant protrudes above the water level. Most plants that are under water either do not survive or drastically reduce their biomass, while plants that remain in contact with the atmosphere, survive, elongate further and gain biomass. Apart from plasticity in shoot elongation, plasticity in root porosity is an important trait determining the plant's biomass response to flooding. It can be concluded that the responses of riparian plant species to increased flooding depth and duration are species-specific and that it greatly depends on flooding depth. A substantial increase in flooding duration and depth can safely be assumed to strongly affect riparian plant communities in the near future. Plant communities are expected to change towards communities with a relatively high number of flood-tolerant species, and in catchments with high nutrient loadings from stream water and sediment, also towards communities reflective of high nutrient availabilities. Changes in vegetation composition and biomass can occur relatively fast, which is demonstrated by our three-year field experiment. Based on our literature survey and field experiment, we suggest that increased flooding is likely to result in initial species losses in riparian zones characterised by previously relatively stable hydrographs. In riparian zones where the frequency and depth of new flooding regimes are too high, and in catchments with high nutrient loadings, increased flooding is likely to result in continued species losses. Our results stress the importance of the conservation of streams and their riparian zones at the landscape or catchment scale (Brederveld *et al.*,

2011, Verhoeven *et al.*, 2008) and the inclusion of riparian zones in International water legislation such as the Water Framework Directive.

References

- Bailey-Serres, J, Voesenek, LACJ (2008) Flooding stress: acclimation and genetic diversity. *Annual Review of Plant Biology*, 59, 313-339.
- Brederveld, RJ, Jaehnig, SC, Lorenz, AW, Brunzel, S, Soons, MB (2011) Dispersal as a limiting factor in the colonization of restored mountain streams by plants and macroinvertebrates. *Journal of Applied Ecology*, 48, 1241-1250.
- Dankers, R, Feyen, L (2009) Flood hazard in Europe in an ensemble of regional climate scenarios. *Journal of geophysical research*, 114, 16 pp.
- van Eck, WHJM, van de Steeg, HM, Blom, CWPM, de Kroon, H (2004) Is tolerance to summer flooding correlated with distribution patterns in river floodplains? A comparative study of 20 terrestrial grassland species. *Oikos*, 107, 393-405.
- Garsen, AG, Soons, MB, Verhoeven, JTA (2014) Effects of climate-induced increases in summer drought on riparian plant species: a meta-analysis. *Freshwater Biology*, 59, 1052-1063.
- Hirabayashi, Y, Mahendran, R, Koirala, S, Konoshima, L, Yamazaki, D, Watanabe, S, Kim, H, Kanae, S (2013) Global flood risk under climate change. *Nature Climate Change*, 3, 816-821.
- Intergovernmental Panel on Climate Change (IPCC) (2007) Synthesis Report: Summary for Policymakers. In: Fourth Assessment Report, IPCC Plenary XXVII, Valencia, Spain.
- Laan, P, Blom, CWPM (1990) Growth and survival responses of *Rumex* species to flooding and submerged conditions: the importance of shoot elongation, underwater photosynthesis and reserve carbohydrates. *Journal of Experimental Botany*, 41, 775-783.
- Poff, LN, Allan, DJ, Bain, MB, Karr, JR, Prestegard, KL, Richter, BD, Sparks, RE, Stromberg, JC (1997) The natural flow regime. *BioScience*, 47, 769-784.
- Verhoeven, JTA, Soons, MB, Janssen, R, Omtzigt, N (2008) An Operational Landscape Unit approach for identifying key landscape connections in wetland restoration. *Journal of Applied Ecology*, 45, 1496-1503.

Changing e-flows resulting from land use change and altered groundwater conditions in the Regge catchment, The Netherlands

Hendriks D et al.

DIMMIE HENDRIKS¹, MARJOLEIN MENS², NIENKE KRAMER², WIEBE BORREN¹ & FERDINAND DIERMANSE²

¹*Groundwater Management Department, Deltares, Princetonlaan 6
Utrecht, 3584 CB, the Netherlands.*

²*Water Risk Analyses, Deltares, Boussinesqlaan 1
Delft, 2629 HV, the Netherlands.*

Introduction

Groundwater is a major element of the water balance in most catchments and river basins. The quality and quantity of the groundwater influence surface waters and influences the ecological functions of surface waters (Hendriks et al., 2014). In many European catchments, a significant part of groundwater bodies are in a less than optimal condition and the supply of groundwater to surface waters is disturbed, both in terms of quantity and quality (Acreman and Ferguson, 2009). In this paper the changes in ecological flows (e-flows) in the Regge catchment are assessed over a 47 year period (1956–2003) using data series of meteorology, discharge, groundwater, and recordings of land use change and alterations to the river system. The goal of our study was to determine if changes in e-flows were the result of climatic changes or land use changes and altered groundwater conditions.

Description of the Regge River and its catchment

The Regge catchment (87.4 km²) is situated in the eastern part of the Netherlands and has a temperate marine climate: P of 800 - 850 mm/yr, T of 9.3 - 9.9 °C, ET of 560 - 570 mm/yr (KNMI). The basin is characterized by a north western slope of 35 to 65 m. The geohydrological structure in the western part consists of thick, aquiferous sediments that reach a depth of approximately 150 m and are intervened by impermeable clay deposits. The geohydrological base in the eastern part reaches to a depth between 10 – 20 m below the surface and is determined by small scale terminal moraines and a low infiltration capacity (De Louw, 2006). Agriculture represents the main land use in the area (60%). Other parts of the catchment are characterized by rural, small scale forest and nature area. Larger urban areas exist in the central part of the catchment (De Louw, 2006).

Data acquisition and analyses

In this study we combined meteorological data with geohydrological data and historical information of anthropogenic alterations in the catchment. Below information on data acquisition is summarized and in Table 1 an overview is given of all available data that were used in this study. An overview of measurement locations is given in Figure 1. In order to determine the relative importance of climate change, change in groundwater conditions, and land use changes, the following data analyses were performed:

- Analysis of changes in e-flows by calculating of flow parameters relevant to e-flows over time (Verdonschot and Van den Hoorn, 2010): mean discharge, median (Q50) discharge, high flow parameters (Q25 and Q5), low flow parameters (Q95 and Q75), and flow variability (Q95/Q5, Q75/Q25, Q95/Q50, and Q75/Q50);
- Climate change analysis based on available meteorological data, consisting of calculation of groundwater recharge as well as standard indexes of precipitation and evapotranspiration (Mishra, 2010);
- Analysis of changes in groundwater conditions independent from climatic effects using impulse-response modelling of groundwater data series (Berendrecht, 2004);
- Statistical trend testing of the time series of flow parameters, climatic parameters, and groundwater by Student's t-tests. Significantly non-stationary trend lines ($p < 0.05$) were considered to have a significant increasing or decreasing trend. Due to a data gap between 1985 and 1990 and change of measurement techniques, all tests were performed for the period 1956-1985 and 1990-2003 separately;
- Finally, a time-line of the anthropogenic alterations in the catchment was made for the period 1950 – 2010.

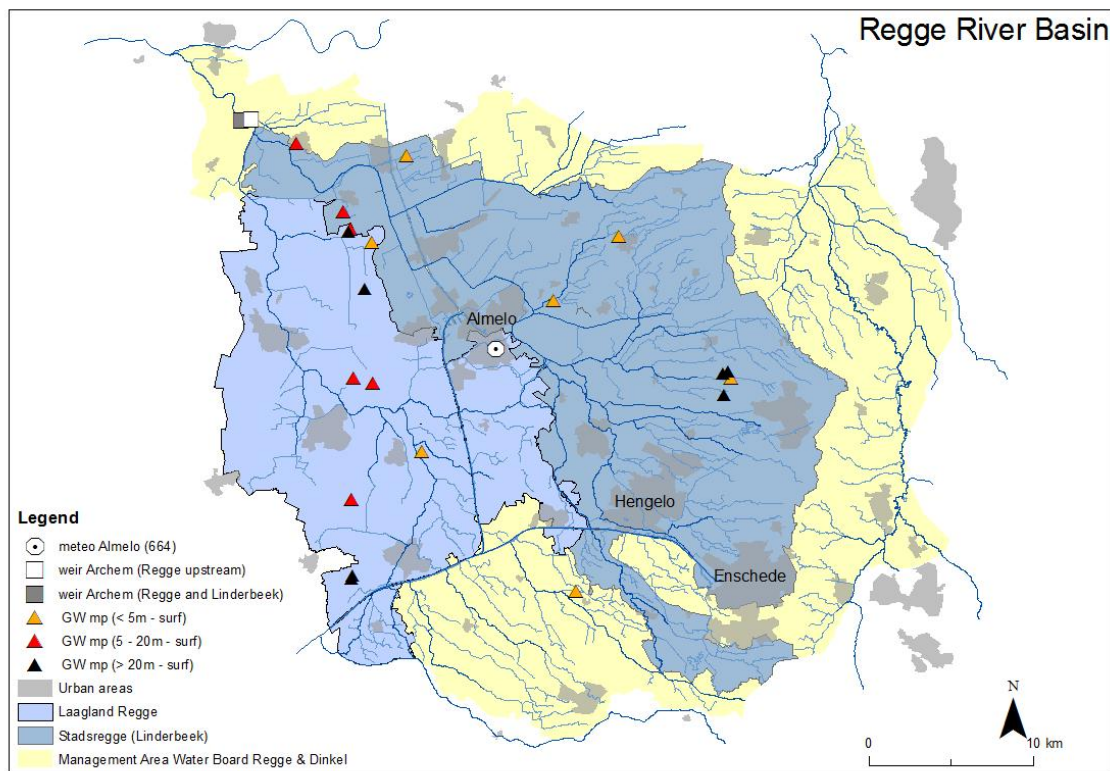

Figure 1. Regge catchment with its' main sub-catchments, streams, urban areas, and measurement locations of meteorological station, weirs for discharge measurements, and groundwater level observations.

Results data analyses

The graphs in Figure 2 display the annual values of the flow parameters and variability of the discharge from the Regge catchment. The first measurement period (1956 – 1983) showed a decrease of high flows (Q5 and Q25). During the second period, mainly low

flows (Q95 and Q75) increased. The mean discharge of the Regge River showed no trend over the first or second measurement period. Flow dynamics decreased for both periods, indicating that the yearly discharge of the stream consisted increasingly of base flow. Figure 3 shows the standard indexes of P (SPI) and ET (SEI) calculated on decadal basis. SPI showed no significant trend, while SEI showed a significant increasing trend over the second test period. This indicates drying conditions over the period 1990-2003. Figure 4 shows the time series of the residual of the groundwater level data series calculated with impulse-response modelling for the two longest groundwater level data series. Groundwater residuals significantly decreased between 1950 and 1990, and significantly increased between 1990 and 2005. In Figure 5 a time-line is shown of both anthropogenic alterations to streams and land-use changes since 1940. Pervious to these alterations, around 1900 activities commenced that promoted navigation and agriculture consisting of straightening and deepening of streams as well as drainage of agricultural areas and construction of weirs in streams.

Table 1. Summary of meta-data of the available meteorological, geohydrological and historical observations from the Regge catchments.

Data type	Number of locations	Location	Measurement frequency	Measurement Period	Source
Precipitation	1	Almelo	daily	1951-2012	KNMI
Evapotranspiration	1	De Bilt	daily	1902-2012	KNMI
Groundwater level < 20 m -surf	13	see map (fig. 4)	daily to two times per month	1951-2012	TNO (DINO)
Groundwater level 20 - 30 m -surf	7	see map (fig. 4)	daily to two times per month	1949-2005	TNO (DINO)
Discharge measurements	2	Archem	daily	1956-2003	Waterboard Regge and Dinkel, Province Overijssel
Changes in water management	--	--	--	~1934-1995	Waterboard Regge and Dinkel
Changes in stream morphology	--	--	--	1924-1995	Waterboard Regge and Dinkel
Changes in landuse	--	--	once per year (31 december)	1951-2012	statistical office Netherlands
Population development	6	Almelo, Enschede, Hellendorn, Borne, Haaksbergen, Hengelo	once per year (31 december)	1951-2012	statistical office Netherlands

Conclusions

During both periods, flow dynamics decreased and the Base Flow Index (Q95/mean discharge) increased. During the first period (1956-1985) this change in flow dynamics is mainly due to a decrease of high flows (Q5 and Q25), while during the second period (1990-2003) this change is mainly due to an increase of low flows (Q95 and Q75). P showed no significant trend for both analyses periods, while ET showed an increase during the second period (1990-2003). This limited change of meteorological conditions is reflected in the absence of significant changes in mean discharge. Since the significant long term trends in flow dynamics were probably not caused by long term meteorological changes, other causes should be present. The increase in low flows (Q95 and Q75) during the second period (1990-2003) is in accordance with the observed increase in groundwater levels. Also, the decrease in high flows during the first period (1990-2003) may have a relation with the lowering of groundwater levels over this period, as low groundwater levels enhance infiltration of rainwater and surface water into the subsoil.

The e-flow parameters, flow dynamics and groundwater levels are probably strongly affected by the large scale changes to the catchment that occurred in the first half of the 20th century. In addition, a large part of the groundwater level decrease was most probably caused by the combined effect of groundwater abstractions for drinking water, industry and irrigation purposes (1970-2003) and land reallocation (1965-1985). The significant changes in groundwater level (increase) and low flows (increase) during the second period (1990-2003) can be linked to re-naturalization projects that took place in the catchment since the 1990's. Although no direct causal relation between the re-naturalisation and geohydrological changes could be proved, no other large scale changes in the catchment were reported that could cause such a reversal in the geohydrological condition of the catchment.

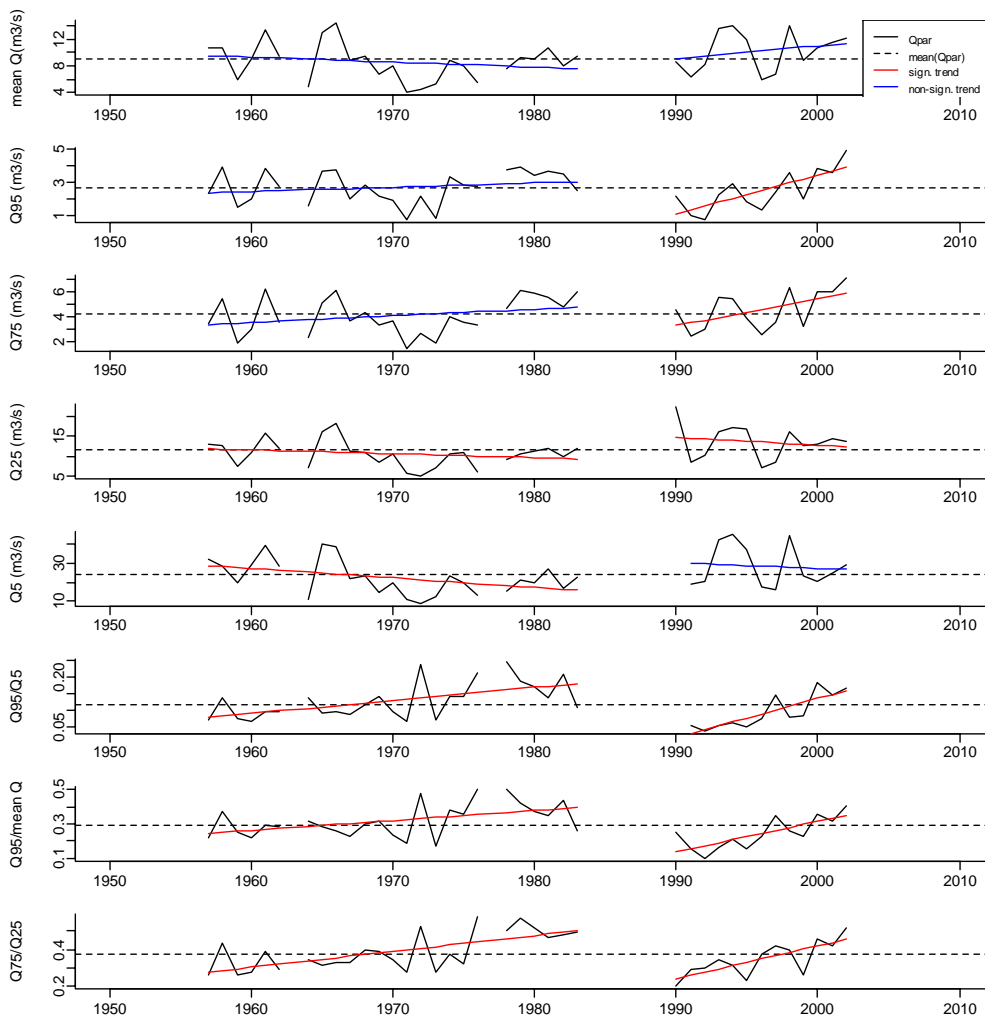

Figure 2. Annual values of the flow parameters and variability for the Regge catchment. Dotted lines indicate average values; red lines indicate significant trend lines; blue lines indicate non-significant trend lines.

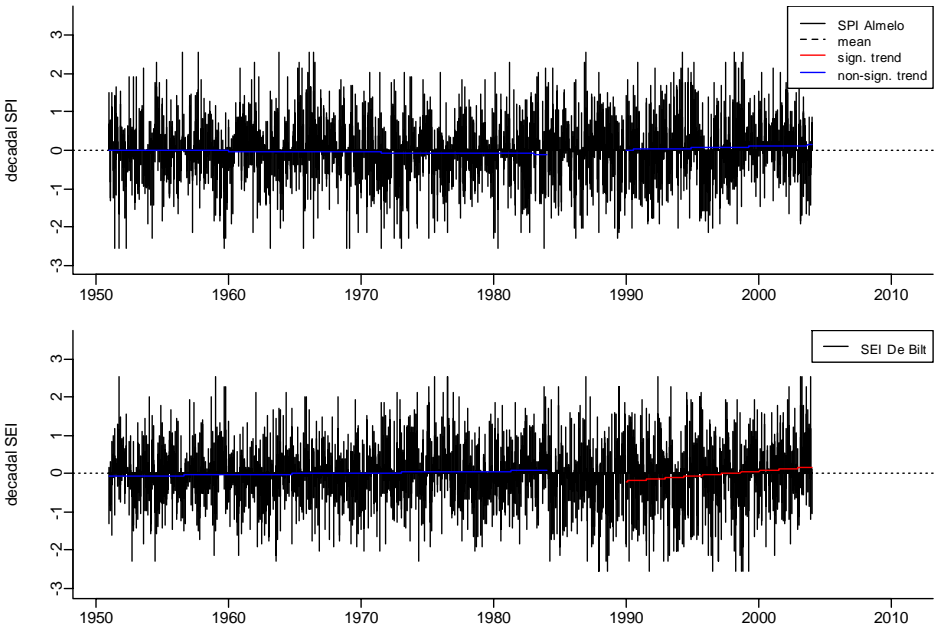

Figure 3. SPI (upper graph) and SEI (lower graph). Dotted lines indicate average values; red lines indicate significant trend lines.

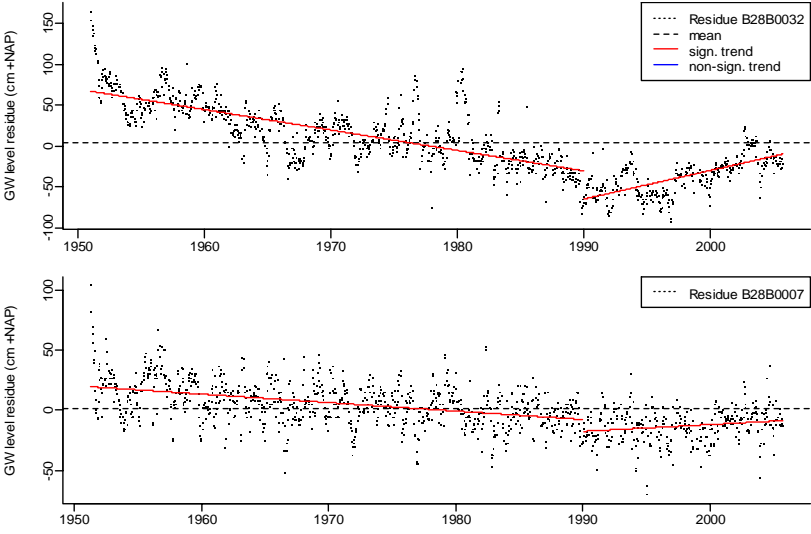

Figure 4. Groundwater level residuals for two groundwater level locations with longest data series. Dotted lines indicate average values; red lines indicate significant trend lines.

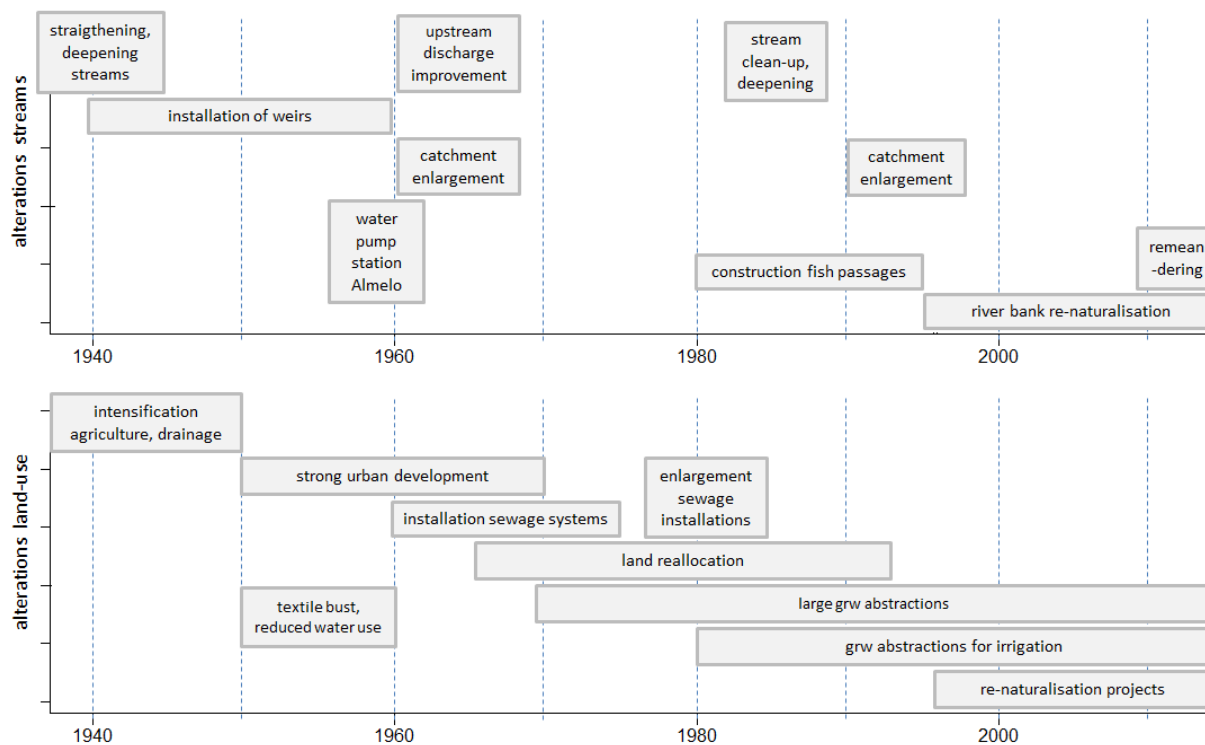

Figure 5. Overview of anthropogenic alterations on streams (upper graph) and land-use (lower graph) in the Regge catchment for the period 1940-2013.

References

Acreman, M.C. and A. Ferguson, 2009. Environmental flows and European Water Framework Directive. *Freshwater Biology*, doi:10.1111/j.1365-2427.

Berendrecht, W., Snepvangers, J. Minnema, B., Vermeulen, P., 2007. MIPWA: A Methodology for Interactive Planning for Water Management, In: Oxley, L. and Kulasiri, D. (eds).

De Louw, P., 2006. *Wateratlas Twente*.

Hendriks, D.M.D., Kuijper M.J.M., and van Ek, R., 2014. Groundwater impact on environmental flow needs of streams in sandy catchments in The Netherlands. *Hydrological Sciences Journal* 59 (3-4) pg. 1–16.

Mishra, A.K. and V. P. Singh, 2010. A review of drought concepts. *Journal of Hydrology* Volume 391(1–2), pg. 202–216.

Verdonschot, P.F.M. and M. van den Hoorn, 2010. Using discharge dynamics characteristics to predict the effects of climate change on macroinvertebrates in lowland streams. *Journal of the North American Benthological Society*, 2010, 29(4):1491–1509. DOI: 10.1899/09-154.1.

Diatoms as indicators of fine sediment stress

Jones J I et al.

Jl Jones¹, T Douthright¹, A Arnold¹, CP Duerdoth¹, JF Murphy¹, JL Pretty¹, & FK Edwards²

¹*School of Biological and Chemical Sciences, Queen Mary University of London, Mile End Road, London, E1 4NS, UK*

²*Centre for Ecology and Hydrology, Maclean Building, Benson Lane, Crowmarsh Gifford, Wallingford, OX10 8BB, UK*

Excessive mobilisation and delivery of fine sediments to water bodies has detrimental impacts on those biotic elements used for waterbody status classification. Typically changes in the diatom assemblage (as either phyto-benthos or phytoplankton) are used to assess the extent of stress from eutrophication. As increased delivery of fine sediment has the potential to impact diatom assemblages in many ways, it is not surprising that indices based on benthic diatom assemblage structure have been proposed. These comprise simply of the relative abundance of motile species. This measure is based on the fact that many raphid species are capable of migrating through deposited sediment to avoid its negative impacts. However, the use of such an index has yet to be fully tested.

Here we used various data analysis techniques to explore how diatoms, and indices based on diatoms (related to both eutrophication and siltation), respond to a gradient of percentage cover of fine sediment. We also explored how two traits, motility and nutrient affinity, were associated with the gradient of fine sediment. We conclude that the relationship between motility and deposited fine sediment is not sufficiently strong to be used reliably as an indicator of fine sediment stress.

Introduction

It has been suggested that benthic algae are particularly prone to the impact of increased fine sediment loads (Jones et al. 2014). As benthic algae are photosynthetic, they are dependent upon light; any increase in the turbidity of the water column caused by suspended fine sediment will reduce light availability and, hence, photosynthesis and biomass of benthic algae. However, the most profound effect of fine sediment is the smothering of substrata to which benthic algae attach by deposited material (Jones et al. 2014). Although, changes in the diatom assemblage (as either phyto-benthos or phytoplankton) are typically used to assess the extent of stress from eutrophication (nutrient pollution as dissolved inorganic phosphorus or to a lesser extent dissolved inorganic nitrogen (e.g. Kelly and Whitton, 1995; Kelly *et al.*, 2001), as increased delivery of fine sediment has the potential to impact diatom assemblages in many ways, it is not surprising that indices based on benthic diatom assemblage structure have been proposed. These comprise simply the relative abundance of motile species (Bahls 1993). This measure is based on the fact that many raphid species are capable of migrating through deposited sediment to avoid its negative impacts.

Further negative effects of hydromorphology could be expected through both direct and indirect impacts on the substrate on which benthic algae grow. Reductions in flow velocity, for example caused by impoundments, would tend to reduce flow velocity and increase the deposition of fine sediment altering both bed substrate and the potential for planktonic algae to thrive. Direct modification of in-stream and marginal habitat has the potential to alter the substrate on which benthic algae grow.

Here we have tested the relationship between indices based on the benthic algal community, particularly benthic diatoms, and hydromorphological alteration. As these indices have been developed to assess eutrophication stress, we have tested whether any change in the benthic algal community associated with hydromorphological alteration influences the relationship between these indices and nutrient stress. Furthermore, we have explored how two key diatom traits, motility and nutrient affinity, are associated with the gradient of fine sediment.

The primary objective of this work is to establish if the relative abundance of motile species is a valid measure of stress from fine sediment: despite being in use for over 20 years this index has yet to be fully tested. We were also interested to determine if hydromorphological alteration confounds interpretation of diatom based indices.

Methods

Data from 1578 sites in Germany, Austria and the Netherlands, collected during WISER, were used to establish the impact of hydromorphological pressure on the relationships between indices based on phytobenthos and phosphorus concentration using ANCOVA. Twelve indices of phytobenthos were investigated, namely Descy, Watanabe, TDI, % planktonic taxa, IPS, IDAP, EPI-D, D-CH, IDP, LOBO, TID and % motile taxa. The influence of six hydromorphological alterations was investigated, namely channel modification, artificial embankment, impoundment, modification of instream habitat, modification of riparian vegetation and velocity increase. Sites were categorized according to the extent of hydromorphological alteration with multiple categories used to describe increasing severity of alteration. Where significant effects of hydromorphological alteration on the relationship between the index and \log_{10} orthophosphate concentration were found, relationships were checked to establish if the results were trivial, i.e. data from modified sites were within the range of scatter of unmodified sites.

Using data collected during STAR from 182 sites across Europe, the relationship between deposited fine substrate on the bed (visual estimates of % composition of fine sediment) and the % motile taxa was investigated using regression. The relationship between % motile taxa and water chemistry variables was also investigated. Where significant relationships were detected with bed composition, analysis was repeated with all sites with zero fine substrate excluded to determine if the results were trivial, i.e. the influence of zero recorded fines was driving the relationship.

Data were compiled from surveys undertaken on behalf of the Welsh Government to assess the effectiveness of agri-environment schemes in Wales (Agri-environment Monitoring and Services Contract Lot 3 183/2007/08 and the Glastir Monitoring and Evaluation Programme). Sites were scattered across Wales, covering a wide range of physico-chemical conditions. Samples were collected for the estimation of the relative

abundance of diatom taxa following the DARES methodology. All taxa that were found in less than 3 % of samples were excluded from analyses. Data on the trait of interest (i.e. mobility) were acquired from Jones et al (2014) and on nutrient affinity (TDI score) from Kelly and Yallop (2012). The physical characteristics of each river reach from which diatom samples were collected was assessed either in the field or from maps, together with visual assessments of substrate composition as percentage cover. Chemical concentrations were determined by standard analytical techniques on water samples collected at the time of sampling or modelled using frameworks capable of estimating pollutant loading from land use within each of the selected catchments.

Data were analysed using partial ordination (pCCA). After the relationship between diatom community composition and a number of candidate environmental variables characterising river condition and type was established, the effect of those environmental variables with a significant influence was removed, leaving only the relationship between fine sediment and diatom taxa. The variation in diatom taxa remaining was that explained by the amount of deposited fine sediment. In simple terms this analytical process was equivalent to establishing: "When all other things are equal, what is the response of diatoms to fine sediment?" The output of the analysis was a single ranking of sensitivity of taxa to fine sediment irrespective of river type. The distribution of the traits of interest, mobility and nutrient affinity, across this axis of fine sediment was then established.

Results

There was a significant relationship with \log_{10} orthophosphate for almost all indices tested. However, no significant effect of any hydromorphological alteration on this relationship was evident for any of the indices. Whilst indices developed to detect the impact of nutrient pollution on phytobenthos should be robust to hydromorphological alteration, the result was somewhat surprising when considering the impacts of hydromorphological alterations (impoundment, channel modification and in-stream habitat modification) on the proportion of planktonic and motile taxa in the community.

In the STAR data, only weak relationships were found between the % motile taxa and the % fine sediment in the substrate, and these were driven by sites where zero fines had been recorded. However, the relationships between % motile taxa and water chemistry showed a strong response to conductivity and phosphate concentration.

The unconstrained CCA on the Welsh data indicated that alkalinity, percentage fine sediment cover, orthophosphate concentration and river slope at the site were best at describing the variation in the diatom taxa. This does not imply that these are the drivers of change in the community, simply that they were the best statistically at describing the observed variation in the community. The resulting model with just these four variables could account for 9.2% of the variation in diatom taxa. Hence, alkalinity, orthophosphate concentration and river slope at the site were used as covariables in the partial ordination, leaving only the influence of percentage fine sediment cover.

The first axis of the pCCA was correlated with percentage fine sediment cover; this axis explained 4.7% of the variation in the diatom taxa. The distribution of the taxa along the gradient of percentage cover of fine sediment was used to rank the diatom taxa from

most to least sensitive to fine sediment (Figure 1). The taxa most strongly correlated with a low percentage cover of fine sediment were *Brachysira*, *Frustulia krammeri*, *Nitzschia tubicola*, *Diademsis contenta*, *Nitzschia gracilis*, and *Surirella crumena*, whilst those most strongly associated with a high cover of fine sediment were *Cocconeis*, *Luticola mutica*, small *Navicula* species, *Navicula capitatoradiata* and *Gyrosigma acuminatum*.

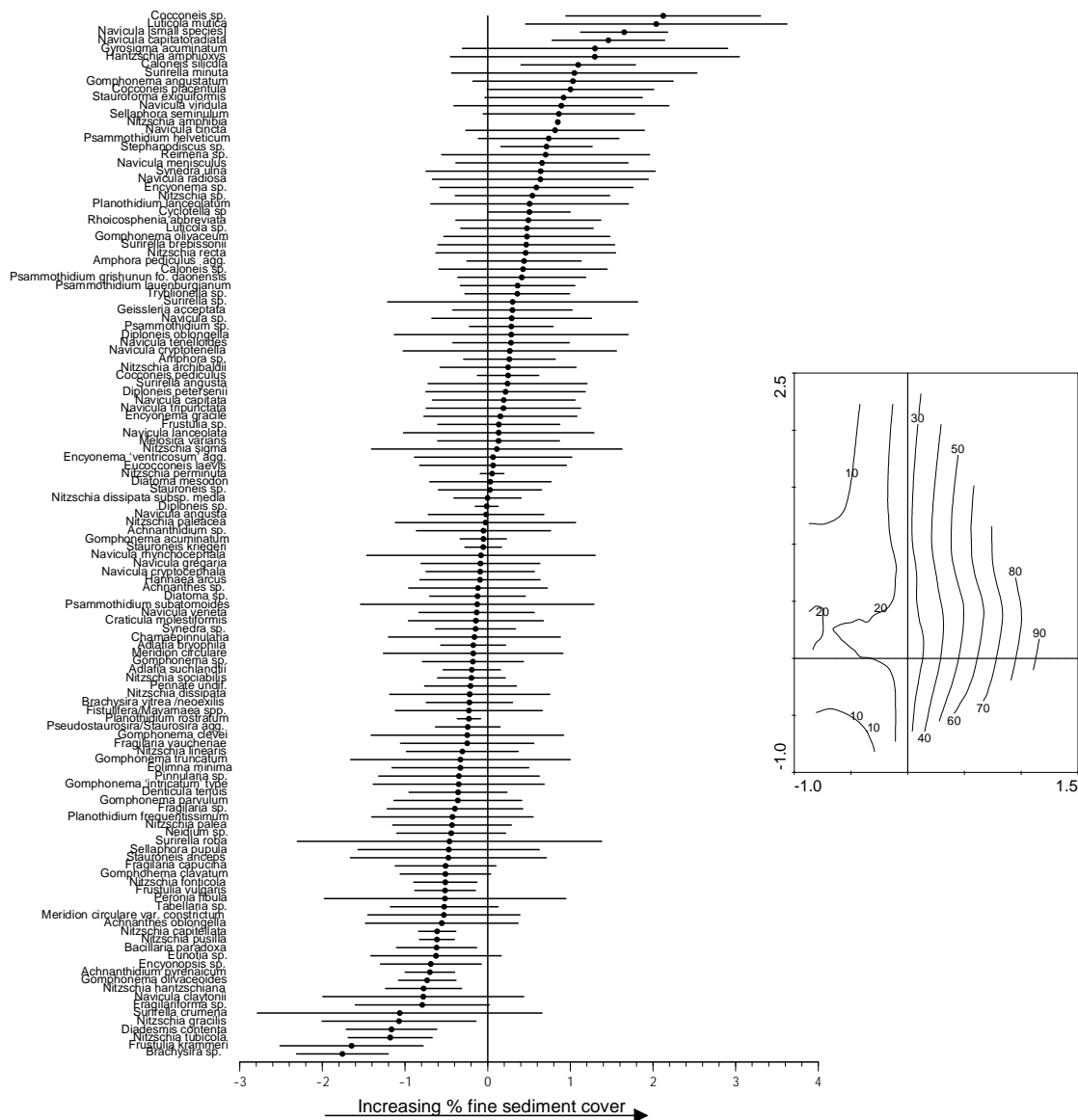

Figure 1. Optimum (point) and amplitude (line) of diatom taxa along the first canonical axis of pCCA, correlated with increasing % fine sediment cover. Taxa are ranked from least sensitive to most sensitive to fine sediment (top to bottom). Inset shows contour gradients of percentage fine sediment cover through pCCA ordination space.

Despite there being a strong influence of percentage cover of fine sediment on diatom community composition, motility appeared to be distributed across the gradient of fine sediment (Figure 2). Both motile and non-motile taxa were found throughout the gradient of percentage fine sediment cover. Nutrient affinity appeared to have some

relationship with the gradient of percentage fine sediment cover, with higher scoring taxa (higher affinity to nutrients) tending to have an association with a high percentage cover of fine sediment. However, nutrient affinity was also scattered across the gradient of percentage cover of fine sediment.

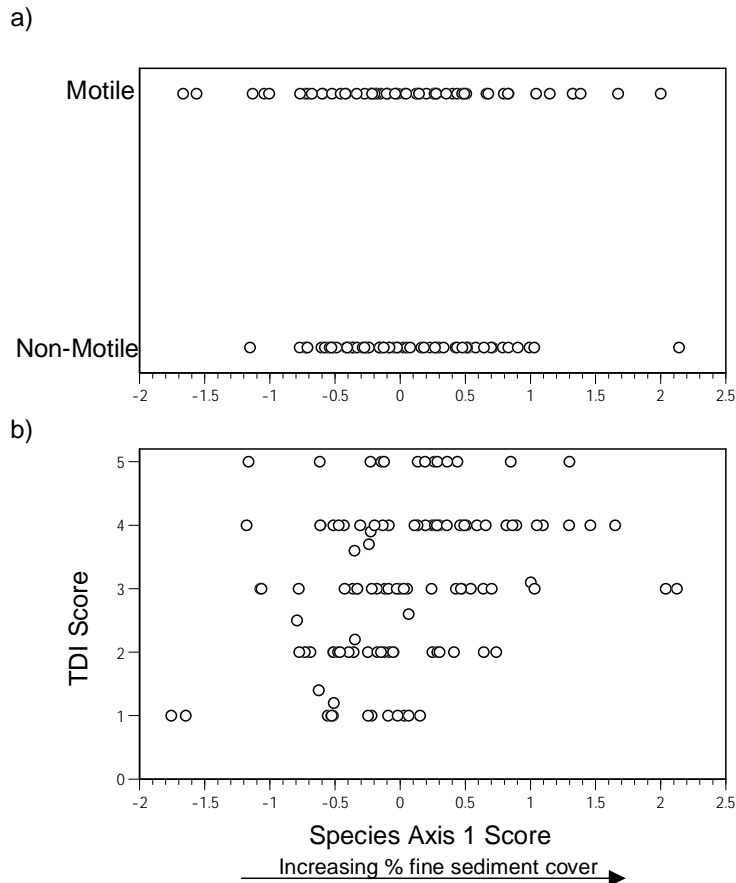

Figure 2. Distribution of two diatom traits, a) motility and b) nutrient affinity (as TDI score) along the first canonical axis of a pCCA, correlated with increasing % fine sediment cover (see Figure 1). The optima of taxa, and their corresponding trait characteristic, are plotted by their pCCA axis 1 scores.

Discussion

It was not possible to detect any effect of the hydromorphological alterations tested on phytobenthos based indices, despite alterations that influence flow velocity, the rate of sedimentation and in-stream habitat being included in the analysis. It is reassuring that indices developed to assess eutrophication appear robust to hydromorphological alteration. However, it was assumed that general descriptors such as % planktonic taxa and % motile taxa would respond to hydromorphological alterations. Indeed, substrate is thought to have a substantial influence on benthic algal community composition and % motile taxa has been proposed as an index of deposited fine sediment (Bahls, 1993). Furthermore, it is recommended that % motile taxa is used when interpreting indices such as TDI (Kelly et al. 2001).

It is possible that the categorisations of hydromorphological alteration did not adequately describe the extent of alteration, resulting in the negative result. However, both the STAR data indicated that % motile taxa was not related to visual estimates of the percentage fine sediment in the bed substrate. Rather, % motile taxa appears to be related to nutrient conditions. This could be a consequence of competition for light between algal species favouring those taxa that can migrate to the top of the layer of benthic algae when nutrients are abundant, or simply that many species with these characteristics (small, rapidly growing, motile) are indicative of high nutrient conditions (Kelly et al. 2001).

Nevertheless, the Welsh data indicated that percentage cover of fine sediment had a strong influence on diatom community composition, and it was possible to rank the taxa according to their affinity to this gradient. However, motility did not show a strong association with the gradient of percentage cover of fine sediment. It appears that motility is a trait characteristic of taxa associated with a wide range of fine sediment conditions and cannot be reliably attributed to any part of the gradient of sediment pressure. Hence, it is recommended that % motile taxa is not used as an index of fine sediment. On the other hand, the strong influence of percentage cover of fine sediment on diatom community composition suggests that there is potential to develop a robust metric relating diatoms to fine sediment pressure.

References

- Bahls LL (1993) Periphyton bioassessment methods for Montana streams. Water Quality Bureau: Helena, MT, USA.
- Jones JI, Duerdoth CP, Collins AL, Naden PS, Sear DS (2014) Interactions between diatoms and fine sediment. *Hydrological Processes* 28: 1226–1237
- Kelly MG, Whitton BA (1995) Trophic diatom index - a new index for monitoring eutrophication in rivers. *Journal of Applied Phycology* 7: 433-444
- Kelly MG, Adams C, Graves AC, Jamieson J, Krokowski J, Lycett EB, Murray-Bligh J, Proitchard S, Wilkins C (2001) *The Trophic Diatom Index: A User's Manual*. Revised edition. R&D Technical Report E2/TR2. Environment Agency: Bristol.
- Kelly MG, Yallop M (2012) *A streamlined taxonomy for the Trophic Diatom Index*. Environment Agency Science Report. SC070034/TR1.

Multiple hydromorphological stressors and their impact on fish populations and riparian and floodplain vegetation in the foreland of alpine regions

Kraml J et al.

JULIA KRAML¹, KATHARINA LEBIEDZINSKI¹, PETER MAYR² & HELMUT MADER¹

¹*Institute of Water Management, Hydrology and Hydraulic Engineering, University of Natural Resources and Life Sciences, Muthgasse 18, 1190 Vienna, Austria.*

²*Vienna, 1190, Austria, Flussbau IC, 10.Oktober Straße 23, Villach, 9500, Austria.*

The biological response of fish populations and riparian and floodplain vegetation to the degradation of river hydromorphology caused by multiple pressures was analysed and discussed for a study site at a river in the foreland of an alpine region within the central highlands. The river bed with its multiple branches, wide structural varieties and the extended riparian landscape were continuously changed by floods over a time period of several thousands of years. After the increasing human influences on the river system since 1885 in terms of river regulations, change of land use, gravel extraction and hydropower plants the river has changed substantially. Nowadays monotonous straightened single bed rivers characterize the landscape. The mechanistic understanding of the biological response to hydromorphological degradation over a time period of more than 100 years was focus of investigations. Analyses of hydrological information, morphological aspects in terms of modelling results, riparian and floodplain vegetation as well as records of the numbers of fish species show a clear degradation of species and loss of variability and habitat. Fish datasets are also linked with a conceptual fish model to explain changes in the composition of fish communities.

Introduction

The study tracks a river through time starting with its near-natural river form in the 1880s and ending with the current heavily modified river flowing through a monotone canal-like channel. Human alterations to the River Traun increased substantial during the last century in terms of river regulations, change of land use, gravel extraction and hydropower plants. Especially areas of riparian forests as well as areas with low flow velocities and water depths were affected by these developments.

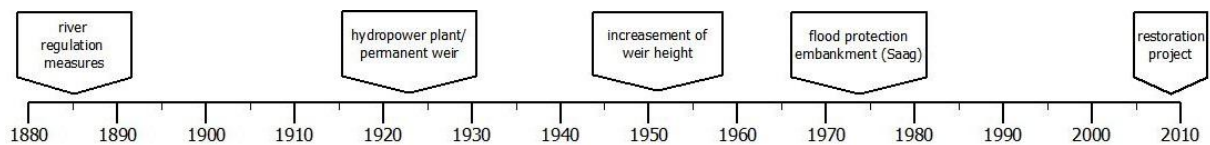

Figure 1. Timeline of significant changes of the study site at the River Traun.

Study site description

Analyses were performed for a river section of the River Traun, which is part of the ecoregion of the Central highlands and the bioregion of the Bavarian-Austrian Alp Foothills. With a total length of 73 km, the River Traun drains a catchment of

2770 km². The study site of the 6th order alpine stream has a total length of approx. 5.5 km and a total project area of approx. 730 ha. Within the epipotamal fish region, grayling (*Thymallus thymallus*), barbel (*Barbatula barbatula*), and nase (*Chondrostoma nasus*) are defined as key fish species for this site. The historical stream course is classified as island braided gravel-bed river while the degraded river situation shows a single bed sinuous to straight gravel-bed river.

Materials and methods

For the hydrological analysis of mean monthly flows datasets of mean daily flow values were used. Datasets were provided by the Hydrographic Service of Austria for the time period between 1890 and 2010. The hydrological classification corresponds with a moderate Nival Flow Regime with a distinct annual character. The key process is snowmelt with a maximum in May or June. The characteristic discharges (Table 2) were used as input for hydraulic modelling and as basis for further analysis.

Table 2. Characteristic discharges and link to applied vegetation zones.

Abbreviation	Definition
NQ _t	Lowest mean daily flow value in the observed period
MJNQ _t	Mean annual daily low flow in an annual series t (vegetation zone 1)
MQ	Mean flow value in the observed period (vegetation zone 2)
HQ ₁	Flood event with a 1-year return period (vegetation zone 3)
HQ ₁₀₀	Flood event with a 100-year return period (vegetation zone 4)
HQ ₃₀₀	Flood event with a 300-year return period

Several datasets beginning in the 17th century provide the basis of historical, hydromorphological assessments. A detailed technical survey, local maps, cross section data and a longitudinal profile of the natural situation of 1885 were available which were used to generate a digital terrain model of the natural river. The basis for the current hydromorphological situation is provided using echo-sounding data, terrestrial measuring data as well as analogue plans of the study site area. Archive data provide the basis of the historical condition of fish abundance. Fish sampling data was collected in the course of a water power plant planning. Quantitative samples were taken in 1985 by electrofishing at five sites in and nearby the study site area. A renewed assessment of fish data was fulfilled for the planning of a restoration project at the study site starting in 2001. Fish habitat classes were developed following a literature research regarding different life stages and corresponding habitat requirements for the key fish species of the study site. Land use mappings of the Franziscan Cadastre, which were established between the 1810s and the 1870s, built the basis for the historical vegetation data. Even the mapping does not define specific species, important information about the vegetation situation can be identified. Furthermore, a collection of several taxa lists provide more detailed information about species, frequency, distribution and threatened species of the historical and the current situation. The development of the vegetation zones is a combined approach which is derived from the delineation from Ellenberg and Leuscher (2010) and the classification developed within the Reform-Project (Gurnel et al., 2014). Hydromorphological and hydrological datasets from the historical and the current situation form the basis to create a digital terrain model and generate a hydraulic model using the software SMS (Surface-Water Modelling System) and Hydro_AS_2D. In addition the geographic information system ArcGIS was used for data preparation and to generate graphs.

Results

The river regulation measures combined with the flood protection dams and the construction of a permanent weir at the River Traun caused significant alterations of the hydromorphological parameters and areas of riparian forests. The data analysis shows a significant reduction of wetted area at low flow, mean flow and an annual flood event over the last century (Figure 2). While the wetted area covered broad sections of the floodplain in 1885, the river stays within the regulated river banks almost entirely in 2006. With the dramatic reduction of river width, increased flow velocities and the increased downward gradient due to the straightening of the river and the cut-off of side arms also the transport capacity increased significantly. These factors combined with a lack of sediment input from the River Traun and its tributaries caused a lowering of the river bed of several meters. Results of analysed hydromorphological parameters are discussed based on the total wetted area of the historical condition of 1885 including riverbanks and islands of mean flow (MQ) for the analysis of fish and of a flood event with a 100-year return period (HQ100) for the analysis of vegetation.

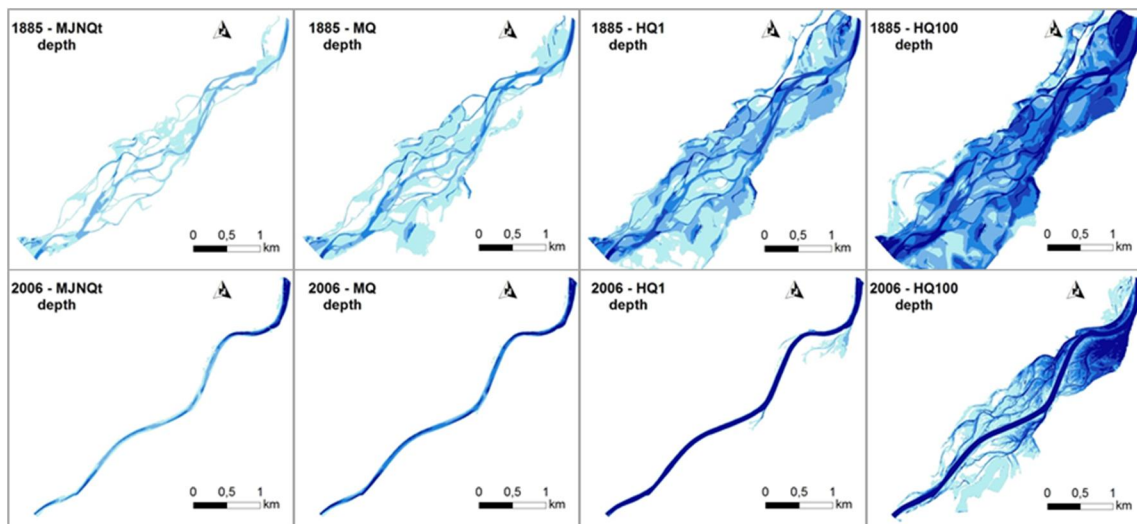

Figure 2. Distribution of water depth at significant flow situations in 1885 and 2006.

The fish habitat classification was established considering the different requirements of habitat for all life stages of key fish species in the epipotamal fish region of the River Traun (Kraml et al., 2014). The detailed analysis of the fish habitat relevant area shows a drastic reduction of available shallow areas which are especially important for juvenile fish and fry (Table 3). At mean annual daily low flow condition, very shallow and shallow areas are cut down from nearly 60 % of the total area in 1885 to approximately 5 % in 2006 while the percentage of great depth area is increasing. The loss of more than 60 % of wetted area at mean flow over the last 120 years has serious consequences on the proportionate areas of flow velocity classes (Figure 3). As an overall result of the multi pressure degradation at the River Traun study site, including both local and regional pressures, only between 8 (1885) and 15 (2001) out of the 39 fish species present in 1885 were observed.

Table 3. Comparison of water depths / flow velocities in 1885 and 2006.

Fish Habitat classes – Depth			Fish Habitat classes – Velocity		
	NQ 1885-2006	MJNQ _t 1885-2006		NQ 1885-2006	MJNQ _t 1885-2006
Not wetted	+ 25,88 %	+ 63,31 %	Not wetted	+ 25,88 %	+ 63,31 %
Very shallow	- 16,39 %	- 34,70 %	Stagnant	- 6,37 %	- 5,65 %
Shallow	- 9,30 %	- 19,10 %	Very slow	- 8,81 %	- 24,20 %
Moderate depth	- 2,72 %	- 12,98 %	Slow	- 3,30 %	- 15,96 %
Great depth	+ 2,54 %	+ 3,47 %	Moderate velocity	- 6,93 %	- 15,43 %
			High velocity	- 0,47 %	+ 2,10 %

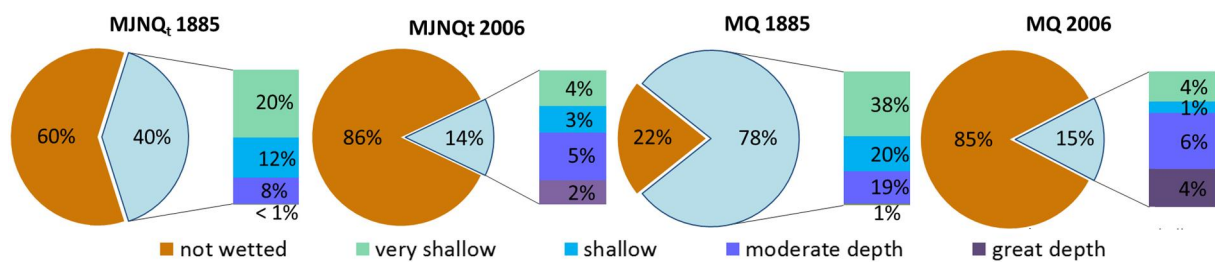

Figure 3. Comparison of water depths at mean annual daily low flow (MJNQ_t) and mean flow (MQ).

A significant reduction at the two assessed situations (1885 and 2006) of the wetted area from 450 hectares down to 60 hectares was detected at a flood event with a 1-year return period. A clear shifting of the distribution of flow velocities as well as water depths to the right was detected for the results of the dataset from 2006 compared to the historical situation (Figure 4). Flow velocities in the range of two to three meters per second increased from approximately 1% in the historical situation to 52% of the total wetted area in 2006. Water depths higher than 2 meters also increased from approximately 2% in historical times to close to 60% in the current situation including the backwater upstream of the weir.

The comparison of the anthropogenic-influenced sinuous straight gravel-bed river and the degraded situation today in terms of vegetation zone classes is presented in Table 4. The distribution graphs should be seen as complementary to the approach of hydrological and fluvial processes gradients that drive the lateral zone mosaic for different river types (Gurnell et al., 2014; Kraml et al., in prep)

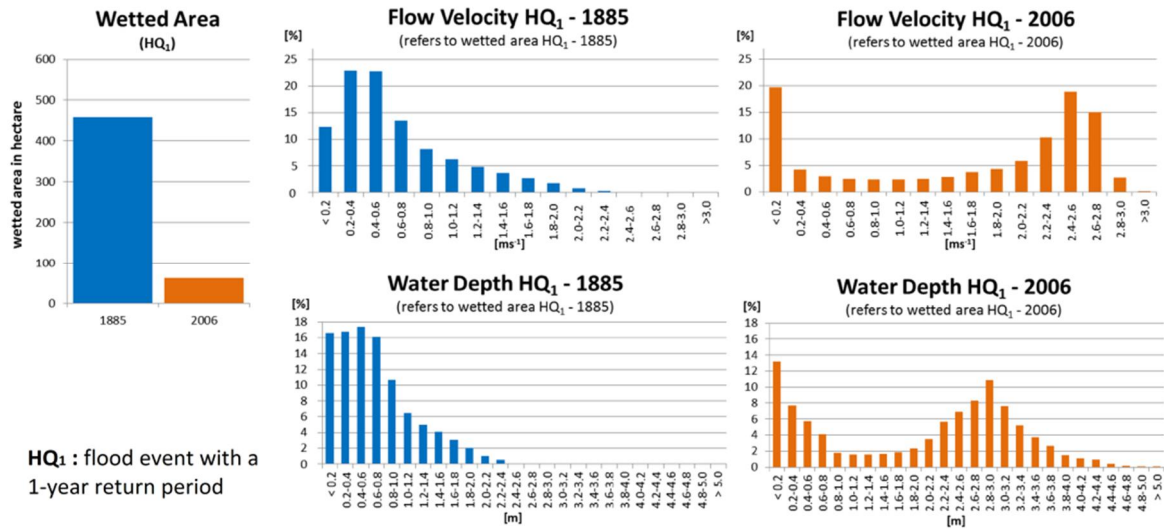

Figure 4. Distribution of water depth and flow velocities at significant flow situations in 1885 and 2006.

Table 4. Classification of vegetation zones and distribution of classes in proportion to the total study site area.

Zone	Definition	Vegetation zones at the study site
1	Perennially inundated/wetted area at mean annual daily low flow in an annual series (MJNQ _t)	
2	Fluvial disturbance dominated (coarse material)/wetted area at mean flow (MQ)	
3	Fluvial disturbance dominated (fine material)/wetted area at annual flood event (HQ ₁)	
4	Inundation dominated (fine material)/wetted area at a flood event with a 100-year return period (HQ ₁₀₀)	
5	Soil moisture regime dominated (fine material)/not wetted area at a flood event with a 100-year return period (outside the riparian forest)	

Discussion

The River Traun regulation at the turn of the 19th to the 20th century marked the beginning of a major structural transformation of the study area. Nowadays the entire study area is affected by anthropogenic measures. In addition to the regulation and straightening of the river, the lower part of the area is influenced by a permanent weir of a downstream hydropower plant and a flood protection dam, cutting off the river from its floodplain in the northwest part of the study area. Side arms and wet areas of the riparian forest are dried up and have partly been turned into fields. The deepening of the nowadays single bed river has caused a significant lowering of the groundwater table. The variability of characteristic parameters like water depth and flow velocity as well as variance of river widths is decreasing drastically. Typical, natural sections with

high variety of river widths, water depths, flow velocities and substrates are representing the historical condition of the River Traun driven by natural hydrodynamic processes. Riffle and pool sequences in the main river as well as in multiple side arms were well developed at that time. The alteration of these parameters, especially at habitat relevant low flow, the loss of wetted areas and the alteration of the hydrograph and the spatial heterogeneity within the river led to the disappearance of a very high percentage of fish species, diversity, stock density and biomass of fish. The validation exercise of the conceptual fish model (Alonso and Noble, 2014) led to the result, that fish presence or absence is a potential useful indicator in a potamal river systems. Very different results are achieved applying the model to study sites in different fish regions, therefore further investigations are suggested to evaluate the utility of the model within different fish regions. The results of the validation exercise shows that some species perform well when predicting the observed effects, while other species with low consistency in their response to hydromorphological pressures in multi-pressure scenarios failed to respond in the observed changes. Results of the very detailed analyses of historical and actual vegetation distribution in combination with hydromorphological data of the 2D hydraulic model at the River Traun site clearly show that floodplain forests are unable to persist in channelized single bed rivers with embankments because of a significant drop in the water table. Furthermore, the dynamic forces of flood events are completely lost and species relying on periodic flooding and channel dynamics disappeared. Typical shrubbery pioneer sites and softwood riparian forests have disappeared and been replaced by mainly hardwood riparian forest. This development makes the River Traun study site representative for a large number of European rivers where similar developments took place.

References

- Alonso, C., Noble, R. A. (2014) Linking fish distribution to hydromorphological stress – method development. Deliverable 3.2 of REFORM (REstoring rivers FOR effective catchment Management), a Collaborative project (large-scale integrating project) funded by the European Commission within the 7th Framework Programme under Grant Agreement 282656 (89-100)
- Ellenberg, H., Leuschner, C. (2010) Vegetation Mitteleuropas mit den Alpen: in ökologischer, dynamischer und historischer Sicht
- Gurnell, A.M., Tánago, M.G.D., O'Hare, M.T., Van Oorschot, M., Belletti, B., Buijse, García De Jalón, D., Grabowski, R., Hendriks, D., Mountford, O., Rinaldi, M., Solari, L., Szewczyk, M. and Vargas-Luna, A. (2014) Influence of Natural Hydromorphological Dynamics on Biota and Ecosystem Function. Deliverable 2.2, Part 1, of REFORM (REstoring rivers FOR effective catchment Management) 7th Framework Programme under Grant Agreement 282656 (20-59)
- Kraml, J., Lebieczinski, K., Mader, H., Mayr, P. (2014) Fish – stress from multiple interacting hydromorphological stressors over time – three Austrian Case studies. Deliverable 3.2 of REFORM (REstoring rivers FOR effective catchment Management) 7th Framework Programme under Grant Agreement 282656 (89-100)
- Kraml, J., Lebieczinski, K., Mayr, P., Mader, H. (in prep.) Riparian and Floodplain Vegetation – Hydromorphology Interactions – an Austrian Case study. Deliverable 3.4 of REFORM (REstoring rivers FOR effective catchment Management) 7th Framework Programme under Grant Agreement 282656

Can macroinvertebrate biological traits be used to indicate the quantity of fine-grained sediment conditions in stream beds?

Murphy J F et al.

J.F. MURPHY¹, J.I. JONES¹, A. ARNOLD¹, C.P. DUERDOTH¹, J.L. PRETTY¹, P.S. NADEN², D. SEAR³, A.L. COLLINS⁴

¹*School of Biological and Chemical Sciences, Queen Mary University of London, Mile End Road, London, E1 4NS, UK.*

²*Centre for Ecology and Hydrology, Maclean Building, Benson Lane, Crowmarsh Gifford, Wallingford, OX10 8BB, UK.*

³*Geography and Environment, University of Southampton, Highfield, Southampton, SO17 1BJ, UK.*

⁴*Sustainable Soils and Grassland Systems Department, Rothamsted Research, North Wyke, Okehampton, EX20 2SB, UK.*

Sediment plays a pivotal role in determining the physical, chemical and biological integrity of aquatic ecosystems. However, human activities have increased loads of fine-grained sediment to such an extent that it has been suggested that it is one of the most widespread and detrimental forms of aquatic pollution. Enhanced inputs impact adversely upon aquatic ecosystems both by degrading habitat condition and by directly impairing biota. Furthermore, the biological impact of fine-grained sediment is likely to be a consequence of a combination of the source and both the amount and rate of delivery and retention, as well as the susceptibility of the resident community to any impact. Here we report the results of an investigation into the impact of fine-grained sediment on a suite of macroinvertebrate biological traits. We identified biological traits whose prevalence significantly increased e.g. ovoviviparity and those traits whose prevalence decreased e.g. univoltinism and semivoltinism, with an increasing mass of fine-grained sediment in the stream bed. These results demonstrate the potential for macroinvertebrate biological trait data to be used to detect the ecological impact of excessive fine-grained sediment stress on river communities.

Introduction

River managers and the freshwater scientific community have a long-standing awareness of the detrimental impacts of fine-grained sediment (inorganic and organic particles of less than 2 mm diameter) on aquatic ecosystems (Jones et al. 2012). Excessive delivery and retention of fine-grained sediments can impact (both directly and indirectly) all components of the biological community of freshwaters (Collins et al. 2011). Different components of the macroinvertebrate community are likely to respond to different aspects of these impacts depending on their intrinsic biological traits, for example certain taxa are likely to be susceptible to the chemical changes associated with the amount of organic matter deposited on the river bed, whereas others may be more susceptible to the physical impacts of inorganic fine-grained sediments (Culp et al. 1986).

Recent research in the UK has improved our understanding of how benthic macroinvertebrate communities respond to increasing fine-grained sediment stress

(Murphy et al. submitted). However, these findings focus on compositional changes. There have been recent developments in European and North American freshwater research into the examination of multiple biological traits of aquatic organisms in the context of various environmental constraints (Zuellig & Schmidt 2012). There is a need to better understand how the prevalence of biological traits in the macroinvertebrate community changes along a gradient of increasing fine-grained sediment stress. The biological trait approach could lead to more widely applicable diagnostic indices of impact, as opposed to the composition-based indices that can be limited to the original development biogeographic region.

The current study seeks to quantify the changes in the lotic macroinvertebrate biological trait assemblage across a gradient of increasing agricultural fine-grained sediment delivery and retention. These analyses are carried out on a biological and environmental dataset collected as part of a UK government-funded project with the objective of extending the evidence base on the ecological impacts of fine sediment on freshwaters. The dataset will be interrogated anew, from a species trait perspective, with the aim of identify suites of traits that are associated with fine-grained sediment stress, and conversely those associated with low stress conditions.

Methods

Field survey

In total, 205 stream sites across England and Wales were sampled between spring 2010 and autumn 2011. Each site was on an independent watercourse, was sampled once with a sample of the macroinvertebrate community and deposited fine sediment being collected. These sites were confirmed to be not impacted by sewage inputs, not to have large urban areas in the catchment and not to have upstream reservoirs or lakes.

The delivery of fine sediment from the catchment to each river sites was modeled using a process-based model of suspended sediment mobilisation in land run-off and subsequent delivery to watercourses (Davison *et al.* 2008). Based on these data we only considered sites with predominantly (>75%) agricultural fine sediment sources.

To ensure that the sampled macroinvertebrate communities came from as wide a range of natural river types as possible, within the limits set by the other site selection criteria, each site was allocated to one of four approximate stream types based on four map-based physical variables; their catchment geology, distance from source, altitude and slope. The fundamental aim was to ensure as equal a sampling effort as possible across the fine sediment stressor gradient for each broad stream type, thus ensuring that a representative sample of streams was included in the study where fine sediment pressure was the main driver of differences in species occurrence.

Macroinvertebrates were sampled at each site using a three-minute kick/sweep and one minute search sample with a pond net (1 mm mesh-size). Associated environmental variables were recorded either at the site (stream width and depth, velocity, substrate composition, pH and conductivity), or from map-based data (discharge category, altitude, distance from source and slope). Macroinvertebrate community samples

returned to the laboratory for subsequent identification and quantification to the lowest practicable taxonomic level.

Fine sediment deposits on the stream bed were quantified immediately upstream of the macroinvertebrate sampling area using the disturbance technique (Duerdoth et al., 2015). Reach-averaged values for total deposited fine sediment were subsequently derived.

In summary, for each site, there was a modelled estimate of the quantity of fine sediment being delivered from the catchment ($\text{kg ha}^{-1} \text{yr}^{-1}$), as well as actual measurements of benthic deposited fine sediment mass and composition and the in-stream biological community.

Compilation of biological trait data

Two existing freshwater macroinvertebrate species trait resources (Tachet et al. 2000; Schmidt-Kloiber & Hering, 2015) were used to gather available biological trait information for the 192 taxa identified in the dataset. Tachet et al. (2000) was the primary source of information and was supplemented with information from Schmidt-Kloiber & Hering (2015). Each biological trait was described by several trait-classes. The trait characteristics of each taxon were scored by assigning a value to each trait-class reflecting the affinity of the taxon to the trait-class. Scores ranged from 0 to 5 indicating no to high affinity respectively. The final dataset contained information on 10 biological traits for 192 distinct taxa.

Data analysis

Our objective was to statistically test the significance of apparent associations between traits and environmental variables by applying Fourth-corner analysis and then a novel RLQ-Fourth-corner combined analysis.

RLQ ordination assigns scores to species, samples, traits, and environmental variables along orthogonal axes allowing the plotting of graphical summaries of the main structures. It does not however allow for any robust statistical test of the significance of any evident trait environmental variable relationships. On the other hand, the Fourth-corner approach measures and tests the correlation between each trait/trait-class and each environmental variable but does not take into account any potential covariance between traits or between environmental variables (Dray et al., 2014). The significance of correlations was tested using the combined results of 4999 permutations of sites and 4999 permutations of species.

By applying the Fourth-corner approach directly to the outputs from RLQ as opposed to the original R (environmental variables), L (community data) & Q (trait data) tables, we can test the correlations between each trait or trait-class and each RLQ axis and the correlations between each environmental variable and each RLQ axis. This combined approach is used to maximise the complementarity between these two methods and improve our interpretation of trait–environment relationships.

Results

In total, 126 out of the 1134 pairwise correlations between trait-classes and environmental variables were found by Fourth-corner analysis to be statistically significant (11%), involving 10 of the 54 trait classes across 6 traits. Only % organic fines in depositional habitats and % Clay were found to be uncorrelated with any trait-class. An increase in the mass of fine sediment in the stream bed was associated with a significant increase in the prevalence of adult aquatic stages, ovoviviparity, multiple life cycles within a year, and burrowing. An increase in mass of fine sediment in the stream bed was also associated with a significant decrease in the prevalence of active aerial and aquatic dispersal, the laying of isolated cemented eggs, egg aquatic stages, and crawling. The traits maximum potential size, life cycle duration, mode of respiration and food were not related to any measure of benthic fine sediment stress.

The results of the combined RLQ-Fourth-corner analysis illustrate that there is a significant positive correlation between RLQ-axis1 and prevalence of >1 life cycle per year, adult aquatic stage, ovoviviparity and burrowing. RLQ-axis1 was also positively correlated with many measures of benthic fine sediment mass, and negatively correlated with organic content of fine sediment and modelled delivery of fine sediment to the reach. A significant negative relationship was found between RLQ-axis1 and ≤ 1 life cycles per year, egg aquatic stage, isolated, cemented, eggs, aquatic dispersal, active aerial dispersal, egg resistance stage and crawling. The much less pronounced RLQ-axis2 was positively associated with gill respiration and negatively associated with laying eggs in terrestrial clutches.

RLQ-axis1 was also negatively correlated with variables describing river size e.g. discharge category, distance from source, catchment area, width and depth, but counter-intuitively also with altitude and slope, variables that decrease in magnitude as river size increases. However, these latter two variables were distinguished from the other river-size variables by RLQ-axis2.

Discussion

This work has confirmed that there is a statistically significant association between the condition of streams, in terms of the quantity of benthic fine sediment, and the biological trait characteristics of the macroinvertebrate community found in the stream bed. Correlative analysis of a spatially extensive dataset, specifically designed and collected to investigate benthic fine sediment impacts, has identified consistent patterns in the trait assemblage that could in the future be applied to more manipulative experimental situations or other broad-scale bioassessment surveys.

Along RLQ axis 1 there was a stark negative association between measures of benthic fine sediment mass and measures of stream size such as distance from source, width and depth. This reflects the fact that there is a natural tendency for larger watercourses to have a greater quantity of benthic fine sediment as the hydromorphological character changes from turbulent eroding shallow headwaters to deeper, more laminar-flowing, depositing rivers. The RLQ – Fourth-corner analyses did not seek to factor out this natural longitudinal gradient but this would be something worth exploring further if the approach allowed co-variables to be defined and a 'partial RLQ' to be carried out.

Nonetheless, we have robustly identified those macroinvertebrate traits that are indicative of low and high fine sediment conditions. This knowledge will help lead to the development of a biological trait-based index of fine sediment stress.

Table 1. Results of combined RLQ and Fourth-corner analysis. (a) Fourth-corner tests between the first two RLQ axes for environmental variables (RLQ-R1/R2) and traits. Only traits with significant correlations to RLQ axes are shown. (b) Fourth-corner tests between the first two RLQ axes for traits (RLQ-Q1/Q2) and environmental variables. Significant ($P < 0.05$) positive and negative associations are represented by red and blue cells respectively. Non-significant associations are in grey. P -values were adjusted for multiple comparisons using the false discovery rate procedure. RLQ axes eigenvalues are also displayed.

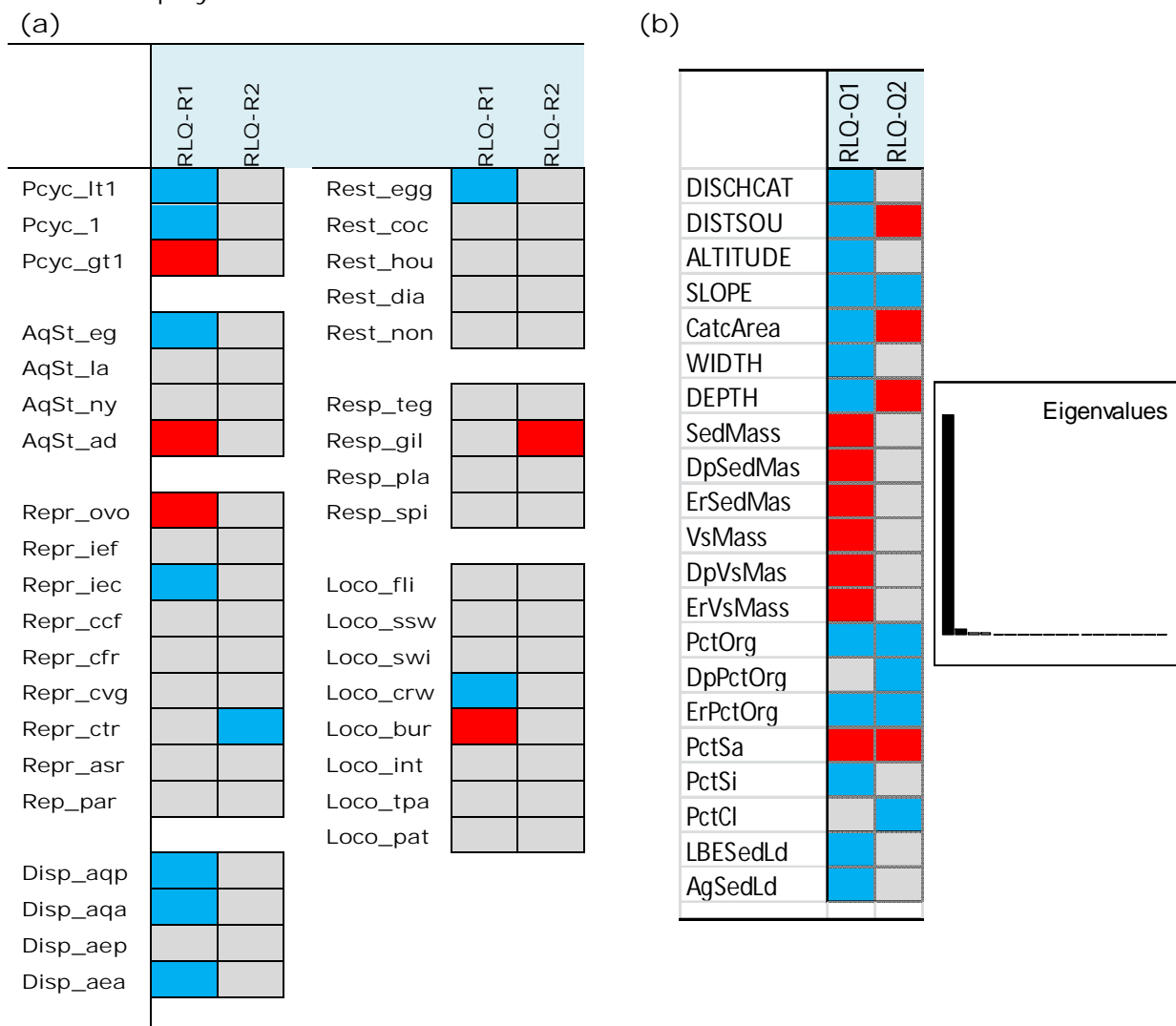

References

Collins AL., Naden PS, Sear DA, Jones JI, Foster IDL & Morrow K (2011). Sediment targets for river catchment management: international experience and prospects. *Hydrological Processes* 25: 2112-2129.

Culp, J.M., Wrona, F.J. & Davies, R.W. (1986). Response of stream benthos and drift to fine sediment deposition versus transport. *Canadian Journal of Zoology* 64: 1345-1351.

Davison P.S., Withers, J.A., Lord, E.I., Betson, M.J. and Strömqvist, J. (2008). PSYCHIC – A process-based model of phosphorus and sediment mobilisation and delivery within

- agricultural catchments. Part 1: Model description and parameterisation. *Journal of Hydrology* 350: 290-302.
- Dray, S., Choler, P., Doledec, S., Peres-Neto, P.R., Thuiller, W., Pavoine, S. and ter Braak, C.J.F. (2014) Combining the fourth-corner and the RLQ methods for assessing trait responses to environmental variation. *Ecology*, 95, 14-21.
- Duerdoth, C.P., Arnold, A., Murphy, J.F., Naden, P.S., Scarlett, P., Collins, A.L. *et al.* (2015) Assessment of a rapid method for quantitative reach-scale estimates of deposited fine sediment in rivers. *Geomorphology* 230: 37-50.
- Jones, J.I., Murphy, J.F., Collins, A.L., Naden, P.S., Sear, D.A. & Armitage, P.D. (2012). The impact of fine sediment on macro-invertebrates. *River Research and Applications* 28: 1055–1071.
- Murphy, J.F., Jones, J.I., Naden, P.S., Pretty, J.L., Duerdoth, C.P., Hawczak, A., Arnold, A., Blackburn, J.H., Sear, D., Hornby, D. & Collins, A.L. (submitted). Development and independent testing of a new biotic index of stream macroinvertebrate community response to deposited fine sediment stress. *Freshwater Biology*.
- Schmidt-Kloiber, A. & Hering D. (2015): www.freshwaterecology.info - an online tool that unifies, standardises and codifies more than 20,000 European freshwater organisms and their ecological preferences. *Ecological Indicators* 53: 271-282.
- Tachet H., Bournaud M., Richoux P. & Usseglio-Polatera P. (2000). *Invertébrés d'eau douce : systématique, biologie, écologie*. CNRS Editions, Paris, 588 p.
- Zuellig, R.E. & Schmidt, T.S. (2012). Characterizing invertebrate traits in wadeable streams of the contiguous US: differences among ecoregions and land uses. *Freshwater Science* 31: 1042-1056.

Mechanistic models can help to disentangle effects of different stressors on the macroinvertebrate community in streams

Schuwirth N et al.

NELE SCHUWIRTH¹, PETER REICHERT¹, ANNE DIETZEL² & AMAEL PAILLEX¹

¹*Systems Analysis and Modelling, Eawag, Swiss Federal Institute of Aquatic Science and Technology, CH-8600 Dübendorf, Switzerland.*

Environmental Chemistry, Eawag, Swiss Federal Institute of Aquatic Science and Technology, CH-8600 Dübendorf, Switzerland,

nele.schuwirth@eawag.ch

Summary

Mechanistic models facilitate the synthesis of existing quantitative knowledge about ecological processes that are relevant for ecosystem management. They provide the possibility to integrate different sources of information and to propagate their uncertainty to model predictions.

We developed the mechanistic model Streambugs for the community composition of macroinvertebrates in streams. Macroinvertebrates are susceptible to different kinds of stressors like hydromorphological impairments, input of organic matter, pesticides from point and non-point sources, and temperature changes. The exposure to these stressors varies over space and time. Therefore, it is a challenge to assess the relative importance of stressors and propose effective mitigation options. For river management it is important to anticipate potential effects of different management actions on ecological endpoints. This is even more challenging than predicting potential effects on physico-chemical properties of the ecosystem.

To contribute to the solution of this problem, we combine knowledge from food web ecology, the metabolic theory of ecology, and ecological stoichiometry with the use of functional trait and ecotoxicological databases in the model Streambugs. The model describes the coexistence of macroinvertebrate taxa in streams dependent on different environmental conditions. With this model, we can assess functional as well as structural aspects of river ecosystems and test hypotheses about the influence of different stressors. We will demonstrate the predictive capacity of the model with two case-studies from the Swiss Plateau, the Glatt catchment and the Reform case study Thur/Töss.

Introduction

Macroinvertebrates in streams are exposed to different stressors regarding water quality, hydromorphological conditions, temperature, food availability, etc. Different species occupy different niches and developed different tolerances regarding different stressors. Therefore, macroinvertebrates are used as bioindicators since many decades (e.g. Kolkwitz & Marsson, 1909). Understanding the processes that determine community assembly of macroinvertebrates in streams is therefore of high relevance to guide river management. Community assembly is influenced by the regional species pool formed by

evolutionary and biogeographic processes, dispersal processes, environmental conditions as well as biotic interactions (HilleRisLambers *et al.*, 2012; Lake, Bond & Reich, 2007). Mechanistic models can help integrating existing knowledge about these processes from different fields of ecological theory as well as empirical knowledge collected in autecological data bases.

We developed the model streambugs to predict the community composition of macroinvertebrates in streams under different environmental conditions and their response to management actions like river restoration or water quality improvements (Schuwirth & Reichert, 2013). This model integrates food-web theory, the metabolic theory of ecology (Brown *et al.*, 2004), and ecological stoichiometry (Reichert & Schuwirth, 2010; Andersen, Elser & Hessen, 2004) with the use of functional trait databases (Schmidt-Kloiber & Hering, 2012; Liess & von der Ohe, 2005) to predict the coexistence of invertebrate taxa in streams.

We applied the model to 36 sites in the Glatt catchment of the Swiss plateau with different environmental conditions to predict the probability of observation of taxa from a regional taxa pool (Schuwirth, Dietzel & Reichert, submitted). Furthermore, we applied it to two of the Reform case study sites, the Thur and the Töss on the Swiss Plateau (Paillex *et al.*, in prep.).

Methods

The model streambugs is a food web model that describes growth, respiration and death of invertebrates and periphyton based on environmental conditions and habitat requirements of taxa (Fig. 1). Feeding relationships are inferred from feeding types, body size and food availability (Schuwirth & Reichert, 2013). Habitat requirements and tolerance to water quality impairment of the different taxa are derived from trait databases (Schmidt-Kloiber & Hering, 2012; Liess & von der Ohe, 2005). Uncertainty about model parameters is propagated to model results with Monte Carlo sampling to derive the probability of occurrence for each taxon at each site which can then be compared with their frequency of observation.

For 36 sites at the Glatt catchment on the Swiss plateau we used monitoring data from cantonal authorities about the community composition of macroinvertebrates as well as environmental conditions at each site (Schuwirth, Dietzel & Reichert, submitted). For each of the two streams of the Swiss Reform case study at the Thur and the Töss Rivers, we applied the model to a degraded and a restored site and differentiated between lotic and lentic habitats (Paillex *et al.*, in prep.).

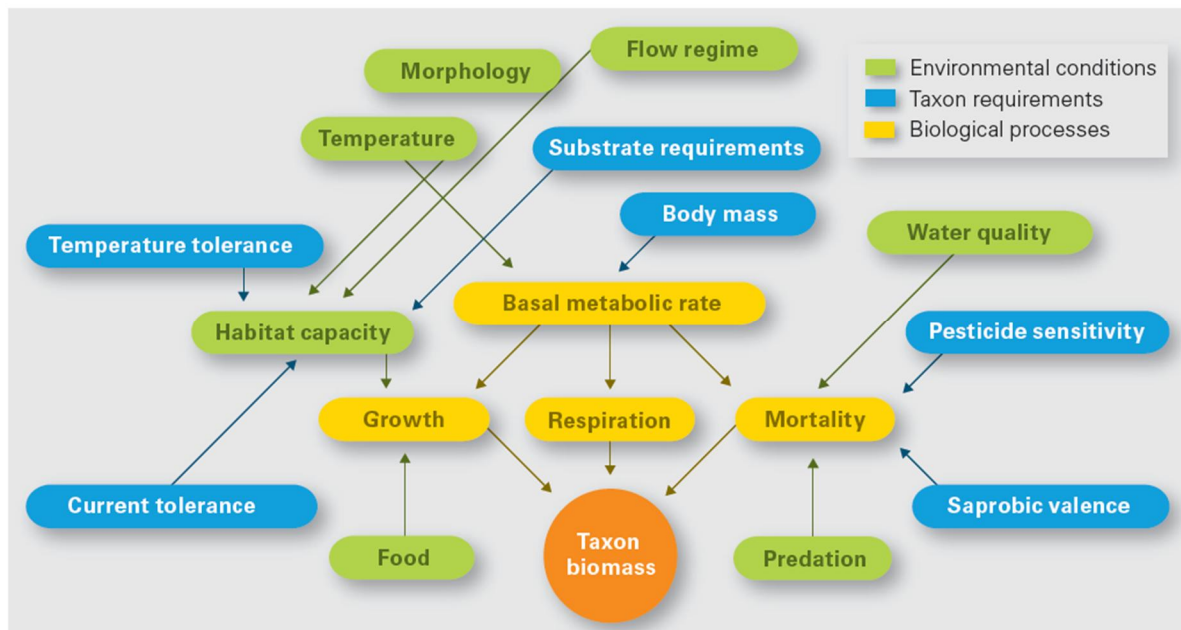

Figure 1. Biological processes, environmental conditions and taxon requirements implemented in the model Streambugs to predict the occurrence of macroinvertebrate taxa (from Schuwirth & Reichert, 2012).

Results

For the 36 sites in the Glatt catchment, we found that without calibrating parameters for 79% percent of the taxa, the difference between the relative frequency of observation and the predicted observation probability is less than 50% when propagating prior parameter uncertainty and the uncertainty of environmental conditions (=model inputs) (Schuwirth, Dietzel & Reichert, submitted). The trait that contributes most to the compliance of model results with observations is the feeding type. This highlights the importance of biotic interactions to predict the community assembly which cannot be easily included in statistical habitat models.

At the Reform case study sites, we had for each taxon of the regional taxa pool one potential observation per site and habitat. This leads to 468 presence/absence data points. Without calibration and just propagation of prior parameter uncertainty, from the 212 observations of taxa in one of the habitats at one of the sites (=“presence” data points), 141 had a predicted probability of occurrence larger than 0.5 at the corresponding habitat and site, which is a fraction of 67%, while 33% were underestimated by the model. From 256 of the taxa that were not observed in the habitats at the sites (=“absence” data points), 162 had a predicted probability of occurrence below 0.5, which is a fraction of 63%, while 37% were overestimated by the model at the corresponding habitat and site (Paillex *et al.*, in prep.). Calibrating the model further increased the compliance of model results with observations.

Conclusions and Outlook

We successfully tested the mechanistic model streambugs to predict the occurrence of macroinvertebrate taxa at different environmental conditions in streams at the Swiss Plateau. While the model still has some deficits, for the majority of taxa the difference

between the observed and predicted frequency of occurrence is below 0.5 without any calibration. A careful analysis of deficits and shifts in parameter probability distributions after Bayesian inference helps to further improve the model. We can then use it to test hypotheses about effects of management actions like hydromorphological restoration or water quality improvements.

References

- Andersen T., Elser J.J. & Hessen D.O. (2004) Stoichiometry and population dynamics. *Ecology Letters*, 7, 884-900.
- Brown J.H., Gillooly J.F., Allen A.P., Savage V.M. & West G.B. (2004) Toward a metabolic theory of ecology. *Ecology*, 85, 1771-1789.
- Hillierislambert J., Adler P.B., Harpole W.S., Levine J.M. & Mayfield M.M. (2012) Rethinking Community Assembly through the Lens of Coexistence Theory. In: *Annual Review of Ecology, Evolution, and Systematics*, Vol 43. (Ed D.J. Futuyma), pp. 227-248. Annual Review of Ecology Evolution and Systematics.
- Kolkwitz R. & Marsson M. (1909) Ökologie der tierischen Saprobien. Beiträge zur Lehre von der biologischen Gewässerbeurteilung. *Internationale Revue der gesamten Hydrobiologie und Hydrographie*, 2, 126-152.
- Lake P.S., Bond N. & Reich P. (2007) Linking ecological theory with stream restoration. *Freshwater Biology*, 52, 597-615.
- Liess M. & Von Der Ohe P.C. (2005) Analyzing effects of pesticides on invertebrate communities in streams. *Environmental Toxicology and Chemistry*, 24, 954-965.
- Paillex A., Reichert P., Lorenz A.W. & Schuwirth N. (in prep.) Modelling the Effect of River Rehabilitation on Invertebrate Communities.
- Reichert P. & Schuwirth N. (2010) A generic framework for deriving process stoichiometry in environmental models. *Environmental Modelling & Software*, 25, 1241-1251.
- Schmidt-Kloiber A. & Hering D. (2012) www.freshwaterecology.info - the taxa and autecology database for freshwater organisms, version 5.0.
- Schuwirth N., Dietzel A. & Reichert P. (submitted) The importance of biotic interactions for the prediction of macroinvertebrate communities under multiple stressors.
- Schuwirth N. & Reichert P. (2012) Predicting the occurrence of macroinvertebrates. *Eawag News*, 72, 14-17.
- Schuwirth N. & Reichert P. (2013) Bridging the gap between theoretical ecology and real ecosystems: modeling invertebrate community composition in streams. *Ecology*, 94, 368-379.

Disentangling stressors in boreal rivers: diffuse pollution overrules channel alteration in degrading river assemblages

Turunen J et al.

JARNO TURUNEN¹, MUOTKA TIMO², VUORI KARI-MATTI³, KARJALAINEN SATU MAARIA¹, RÄÄPYSJÄRVI JAANA¹, SUTELA TAPIO⁴ & AROVIITA JUKKA¹

¹*Freshwater Centre, Finnish Environment Institute, Paavo Havaksen tie 3, Oulu, 90014, Finland*

²*Department of Ecology, University of Oulu, PL 8000 90014 Oulun yliopisto, Finland*

³*Laboratory Centre, Finnish Environment Institute, PL 35, 40014, Jyväskylän yliopisto, Finland*

⁴*Natural Resources and Bioproduction Centre, Natural Resources Institute, Paavo Havaksen tie 3, Oulu, 90014, Finland*

Alteration of channel morphology and nonpoint diffuse pollution from land use are among the most detrimental stressors to stream ecosystems. We explored the interactive and independent effects of morphological channel alteration and diffuse pollution on the diversity and community structure of four organism groups in boreal streams: diatoms, macrophytes, macroinvertebrates, and fish. The community structure of all biological groups responded significantly (PERMANOVA) to diffuse pollution but no response to altered hydromorphology was detected. The ecological status of each stream was evaluated by national WFD bioassessment indices, separately for each taxonomic group. Ecological quality ratio indicated negative response by diatoms, macroinvertebrates and fish to diffuse pollution, but no response to morphological degradation. Our results emphasize that reducing diffuse pollution and associated land use stressors is more important than restoration of channel habitat structure to improve the ecological status of boreal streams.

INTRODUCTION

Stream ecosystems are affected by many anthropogenic stressors simultaneously (e.g. Schinegger et al. 2012) and alteration of channel morphology and nonpoint diffuse pollution from land use are among the most detrimental stressors (Allan 2004). Understanding not only how different stressors affect ecosystem functions and biodiversity, but also unraveling their single and combined effects, is essential for effective management of stream ecosystems (Ormerod et al 2010).

However, as diffuse pollution often co-occurs with alteration of stream channel structure (Schinegger et al. 2012), rigorous designs are needed to disentangle the individual and interactive effects of these two stressors on stream communities. Moreover, the interplay of diffuse pollution and physical channel alteration is of high relevance for resource management as stream restoration activities commonly focus on the re-establishment of natural channel features rather than mitigation of diffuse pollution (Bernhardt & Palmer 2011).

The objective of our study was to explore the interactive and independent effects of morphological channel alteration and diffuse pollution on the diversity and community structure of four key taxonomic groups in boreal streams: diatoms, macrophytes, macroinvertebrates, and fish.

MATERIALS & METHODS

Data

We used a dataset of 96 stream sites in southern and central Finland sampled for diatoms, macrophytes, benthic macroinvertebrates and fish by the Finnish environmental administration and Natural Resources Institute. Water chemistry and land use information were used to quantify the degree of diffuse pollution at each site. To quantify hydromorphological alteration, we conducted a River Habitat Survey (RHS, Raven et al. 1998) and an additional evaluation of the degree of channelization at each site.

The sites represent the least impacted sites (reference) and sites impacted by agricultural diffuse pollution of nutrients and suspended solids and/or alteration of channel morphology, mainly for the purpose of timber transport. To disentangle the independent and interactive effects of the two stressors, we grouped the study sites based on their deviation from reference conditions for diffuse pollution and hydromorphological alteration. This resulted in four treatment groups: (i) least impacted sites with both stressors absent or present at low levels (N=20), (ii) channelized sites with hydromorphological alteration but with minor or no diffuse pollution (N=30), (iii) sites with clear diffuse pollution but with no or minor hydromorphological alteration (N=25), and (iv) sites altered by both diffuse pollution and hydromorphology (N=21).

Statistical analyses

We first used Principal Component Analysis (PCA) to reduce the multidimensionality of the environmental stress gradients into a few interpretable principal components and to visualize in the PCA ordination space the differences between site types in their environmental conditions.

We calculated taxonomic richness for each organism group as the number of taxa occurring at a site. Permutational multivariate analysis of variance (PERMANOVA) was used to test for significant differences in community structure between the stream groups, and to examine whether the differences, if any, were related to diffuse pollution or hydromorphological alteration.

To measure the ecological status of each study site we used indices developed for the national Water Framework Directive (WFD) bioassessment. For diatoms, macrophytes, and invertebrates we used the observed-to-expected taxa ratio (O/E-taxa; Moss et al. 1987) and for fish we used Finnish multimetric Fish index FiFI (Vehanen et al. 2010).

As the sites were grouped by the presence and absence of two stressors, we performed two-way ANOVA separately for each organism group to test whether hydromorphological alteration or diffuse pollution had significant independent and/or interactive effects on taxon richness and ecological status.

RESULTS

The first PCA axis represented a diffuse pollution gradient and the second axis a hydromorphological degradation gradient. Streams grouped by stressor type were distinctly separated in the PCA ordination space (Fig. 1).

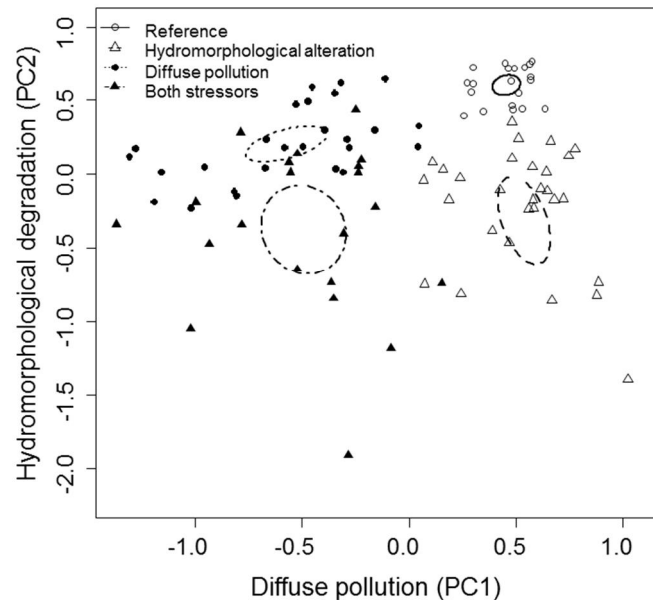

Figure 1. PCA ordination of the study sites. The ellipses describe 95 % confidence ellipses around centroids for each stream group.

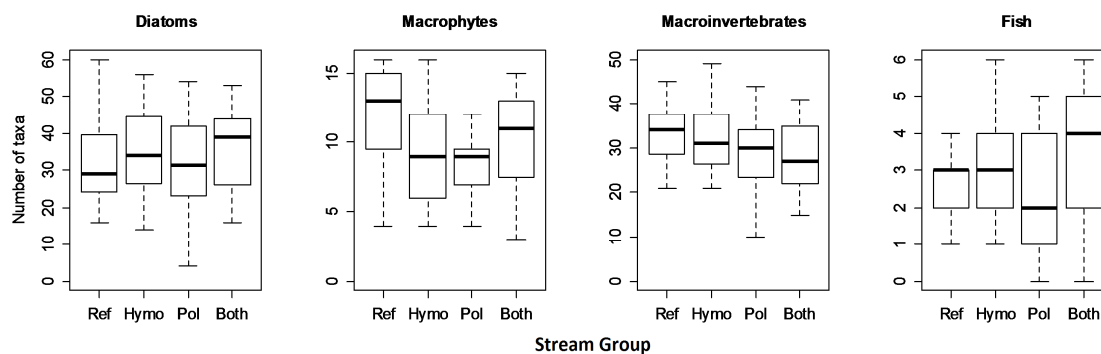

Figure 2. Variation of taxonomic richness in the four organism group among the stressor treatments. Ref = reference sites without hydromorphological alteration or diffuse pollution, Hymo = sites with only hydromorphological alteration, Pol = sites with only diffuse pollution, Both = sites with both stressors present.

In two-way ANOVA, diffuse pollution had a significant negative effect on macroinvertebrate taxonomic richness ($p = 0.007$), but no effect on richness of diatoms, macrophytes and fish (all $p > 0.25$) (Fig. 2). Hydromorphological alteration had no effect on any of the four organism groups (all $p > 0.30$) (Fig. 2). Hydromorphological alteration and diffuse pollution had no significant interactive effects on taxonomic richness,

although a tendency towards such an effect was observed for macrophytes ($p = 0.06$; all other $p > 0.65$) (Fig. 2).

PERMANOVA indicated that community structure was significantly related to diffuse pollution in all organism group (all $p < 0.001$), whereas they were at most weakly affected by hydromorphological alteration (all $p > 0.08$). However, there was a significant interaction between hydromorphological alteration and diffuse pollution on diatom community structure ($p = 0.015$).

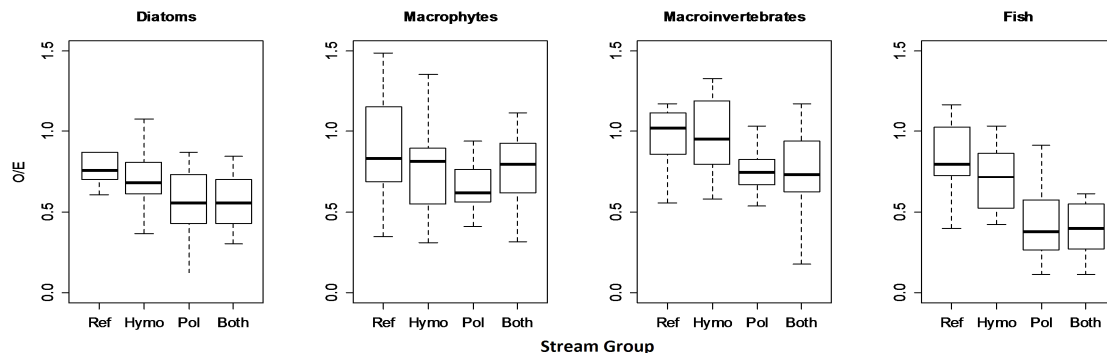

Figure 3. Observed to Expected (O/E) taxa ratio or FIFI (Fish) index values for the four taxonomic groups across the stressor treatments. Ref = reference sites with little or no hydromorphological alteration or diffuse pollution, Hymo = hydromorphological alteration, Pol = diffuse pollution, Both = both stressors present.

Diffuse pollution reduced significantly the ecological status of the streams based on diatoms, macroinvertebrates and fish ($p < 0.001$), but not on macrophytes ($p = 0.110$) (Fig. 3). Hydromorphological alteration had no significant effect on any of the assemblages (all $p > 0.10$) and the interactive effect was non-significant for diatoms, macroinvertebrates, and fish (all $p > 0.25$) whereas it bordered at significance for macrophytes ($p = 0.057$) (Fig. 3).

Discussion

Overall, land use-induced diffuse pollution had a stronger effect on richness, structure and status of the stream assemblages than did hydromorphological degradation. Parallel to earlier work (e.g. Hering et al. 2006), our results thus suggest that diffuse pollution is a much more important factor in altering the biodiversity and community structure of stream organisms than partial alteration of channel morphology.

Agricultural diffuse pollution increases nutrient levels and streambed sedimentation, that alter stream community structure and diversity, as shown in our results. The changes in community structure take place already at low nutrient levels. By contrast, stream assemblages showed only minor response to hydromorphological alterations. Channelization for timber transport often required only the removal of the largest boulders and wood material from the stream channel (Louhi et al. 2011). Therefore, it seems that the physical habitat quality was not a limiting factor for the taxonomic groups.

Our results suggest that restoration of hydromorphology in channelized boreal streams is unlikely to improve the ecological condition if significant diffuse pollution and associated water quality problems persist. Therefore, to improve the ecological status of boreal streams, water resource managers should shift focus from restoring the channel habitat to restoring the surrounding terrestrial landscape, particularly the near-stream riparian habitats to mitigate excess runoff of nutrients and suspended solids from agricultural lands.

References

- Allan, J.D. (2004). Landscapes and riverscapes: The influence of land use on stream ecosystems. *Annual Review of Ecology, Evolution, and Systematics* 35: 257-284
- Bernhardt, E.S., Palmer, M.A. (2011). River restoration: the fuzzy logic of repairing reaches to reverse catchment scale degradation. *Ecological Applications* 21: 1926-1931
- Hering, D., Johnson, R.K., Kramm, S., Schmutz, S., Szoszkiewicz, K., Verdonschot, P.F.M. (2006). Assessment of European streams with diatoms, macrophyte, macroinvertebrates and fish: a comparative metric based analysis of organism response to stress. *Freshwater Biology* 51: 1757-1785
- Louhi, P., Mykrä, H., Paavola, R., Huusko, A., Vehanen, T., Mäki-Petäys, A., Muotka, T. (2011). Twenty years of stream restoration in Finland: little response by benthic macroinvertebrate communities. *Ecological Applications* 21: 1950-1961.
- Moss, D., Furse, M.T., Wright, J.F., Armitage P.D. (1987). The prediction of the macroinvertebrate fauna of unpolluted running-water sites in Great Britain using environmental data. *Freshwater Biology* 17: 41-52
- Ormerod, S.J., Dobson, M., Hildrew, A.G., Townsend, C.R. (2010). Multiple stressors in freshwater ecosystems. *Freshwater Biology* 55 (Suppl. 1): 1-4
- Raven, P.J., Holmes, N.T.H., Dawson, F.H., Everard, M. (1998). Quality assessment using River Habitat Survey data. *Aquatic Conservation of Marine and Freshwater Ecosystems* 8: 477-499
- Schinegger, R., Trautwein, C., Melcher A., Schmutz, S. (2012). Multiple human pressures and their spatial patterns in European running waters. *Water and Environment Journal* 26: 261-273
- Vehanen, T., Sutela, T., Korhonen H. (2010). Environmental assessment of boreal rivers using fish data – a contribution to the Water Framework Directive. *Fisheries Management and Ecology* 17: 165-175.

Morphology revisited; an ecologists view on morphology

Verdonschot P

PIET VERDONSCHOT

Alterra, Wageningen, The Netherlands.

Piet.Verdonschot@wur.nl

Introduction

With a growing interdisciplinary in research and management projects the perspective of how systems or problems are seen and dealt with is diverging. Often, depending on the players within a project, the objectives are set. In water management related projects these objectives and especially the interpretation of them strongly depends on the representatives of the different disciplines involved, like hydrology, morphology, chemistry and ecology, and their disciplinary interpretation of the objectives. Take the example of a Dutch lowland river restoration project with the European Water Framework Directive's (WFD) objective of reaching good ecological status. Here river re-meandering is the most chosen measure. A morphology based intervention were hydrologists pose either or not a risk analysis for the floodplain areas, chemical water quality specialists are often not involved and ecologists think re-meandering results in ecological improvement. But sometimes hydrologists raise the question whether the hydrology fits the re-meandering, or chemistry asks whether ecology will improve at such high nutrient concentrations, or morphologists wonder whether the shape fits the processes, or ecologists doubt the expected habitat heterogeneity. Then, depending on the weights a discipline brings into the project choices are made. Two questions come forward. How can we design restoration projects with more balanced and objectively formulated goals, and How did and do we ecologists look or should look at our rivers? This contribution will deal with part of the second question, the potential role of the ecologists when dealing with morphologists.

The morphologists' approach

River morphology can be approached in different ways. Morphologists developed a number of WFD morphological assessment methods. All are built upon observation of morphological state, shapes and forms in and around rivers. What we observe, we in the field note down on a form and as such what we can see by human eye we consider as being relevant. This approach uses morphology from a human's eye-point of view as being relevant. Scale plays an important role. More often, the micro-, meso- and macro-scale are separated. On micro-scale substrate shapes and patterns are prevailing, at meso-scale channel patterns and types are recorded and at macro-scale network types and valley shapes dominate the classification schemes.

On the other hand, process oriented morphologists take another perspective and studied for a long time all kind of processes that range from processes at a geological time scale toward local erosion-sedimentation processes within a river bed. Leopold & Wolman (1957), Schumm (1977) and Church (2006) developed integrated methods to classify river morphological processes and identified parameters, like channel slope, bank full discharge (Q), sediment load and size, flow, river power (see Lewin and Brewer 2001), width : depth, and bed load and total load (Figure 1).

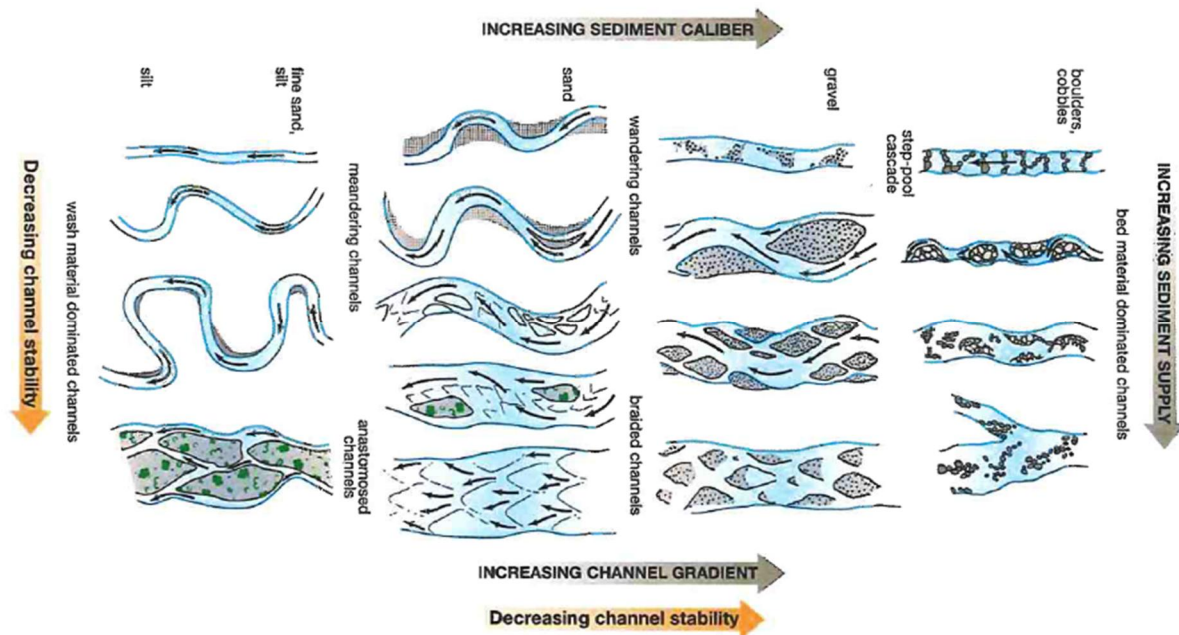

Figure 1. Integrated morphological classification of rivers (Church 2006).

The managers' approach

With the implementation of the Water Framework Directive water managers accelerated their activities to restore rivers. In the Netherlands the ambition included re-meandering of rivers and creating nature friendly banks for the period 2007-2027 over an estimated length of >8000 km and a financial cost of about 929 million euro (PBL 2008).

In practice, until now re-meandering was mainly based on historical maps from the late eighteen or early nineteen hundreds (Figure 2) and nature friendly banks were restricted to small strips of bank area.

Europe wide hydromorphology became part of water management approaches and we counted about 132 hydromorphology based assessment systems (physical habitat assessment 72, morphological assessment 23, fish longitudinal continuity assessment 20, riparian habitat assessment 14, hydrological assessment 10; Figure 3). The methods together cover the whole river valley but why so many and what are the commonalities.

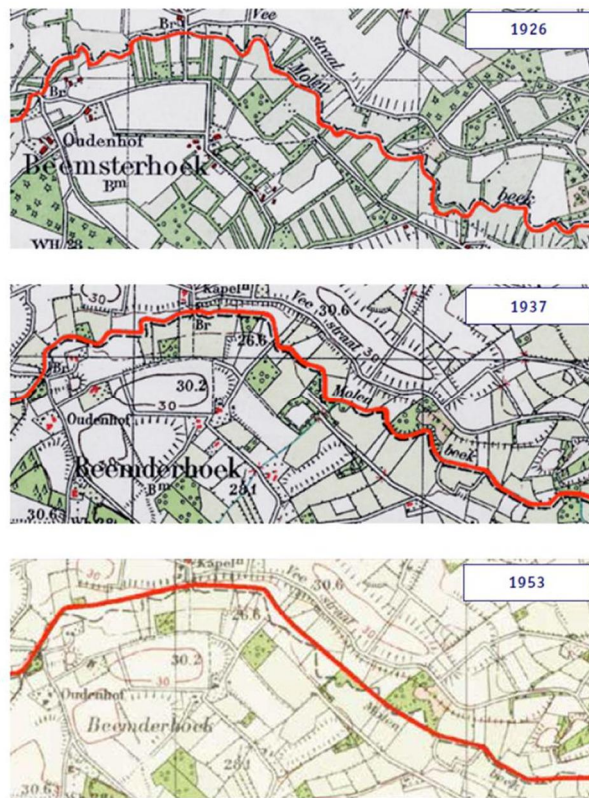

Figure 2. Historical maps as basis for re-meandering of lowland rivers.

		→ Spatial scale			
		Hydraulic/ Sedimentary unit	Morphological unit	Reach	Segment/ catchment
Transversal direction ↓	Channel	Physical habitat assessment 72	Morphological assessment 23	Hydrological regime assessment 10	Fish longitudinal continuity assessment? 20
	Riparian zone / floodplain			Riparian habitat assessment	14

Figure 3. WFD hydromorphology assessment systems evaluated by REFORM.

The ecologists' approach

For an ecologist a river is approached at a relatively small scale. Stretch and habitat were for a long time the main domain. Especially, macro-invertebrates species showed individual preferences for substrate types, like gravel, sand, and coarse and fine organic material (e.g. Tolkamp 1980). Later on, more extensive analyses showed that only a restricted number of taxa, about 23%, had a significant preference but also occurs in other habitats, which means that substrate or habitat type is not the only key for macroinvertebrate distribution (see text box).

A total of 604 habitat-specific macroinvertebrate community samples were taken from 16 different Dutch lowland rivers and contained 547 taxa. The samples were taken from eight predefined habitat types. To investigate taxon-specific habitat preferences, first, the species distributions over the habitat types were tested against random distributions with chi-squared analyses. Then, two independent methods were used, weighted-averaging and the indexes of representation (IR), to determine preferences for specific habitat types. A pre-analysis showed that, in large part, the same information is comprised in the IR values as is comprised in the weighted-average optima, at least for these data. Therefore, in subsequent analyses interpretations on habitat preferences were based on the IR results only. Optima were found for 128 non-randomly distributed species. In conclusion, 51% of all species showed an indicative weight for vegetation, and only 3% for clay. No taxa showed an obligatory preference for one microhabitat, and 77% did not significantly correlate to a single habitat (Verdonschot & Lengkeek 2006).

Still, meandering is generally linked to habitat/substrate diversity and restoration strongly focussed on that. A recent study on meandering of low gradient (slope <1 m/km), sandy (median grain size <250 µm), lowland rivers in the Netherlands showed that meandering is a temporal phenomenon and only occurs in the first period after meander initiation (Figure 4; Eekhout 2014). Such initial meandering starts with local bank erosion, is followed by meander migration and increase of channel sinuosity and quite soon stabilised by riparian vegetation. This results in a stable sinuous planform (local to stretch) over a longer time scale. The main conclusion was that meandering is induced by exogenous influences (weak banks (seepage), clay or peat layers, trees and that Dutch rivers do not (really) physically meander.

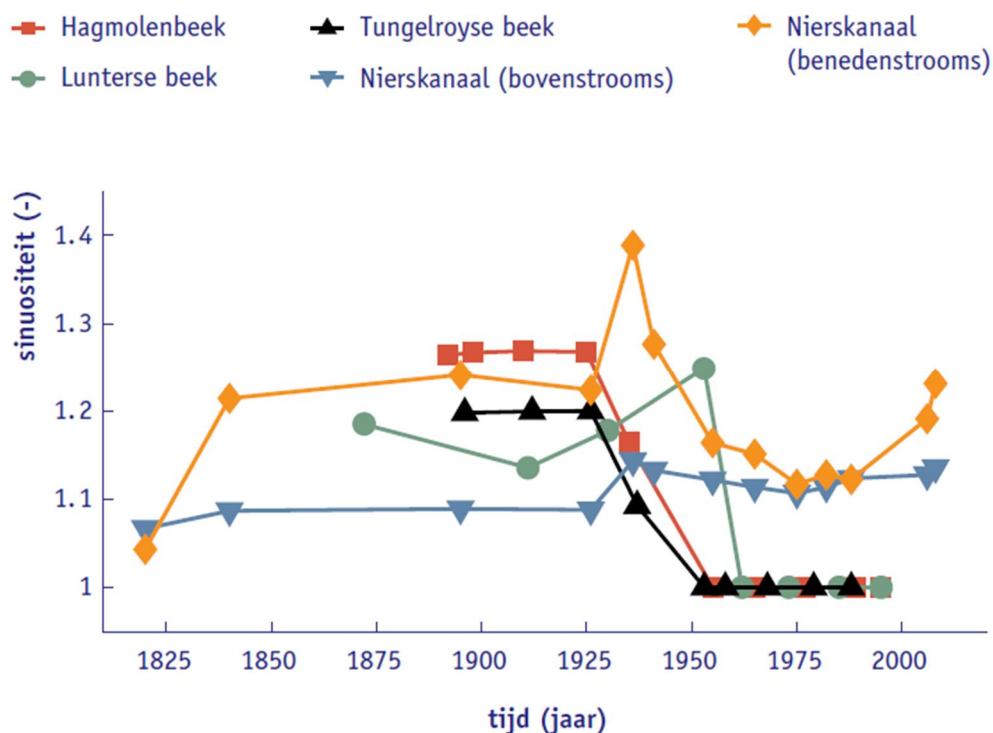

Figure 4. Sinuosity development (vertical axis) over about 200 years (horizontal axis) in four Dutch lowland rivers (Eekhout 2014).

A detailed scaled river stretch-habitat study on macro-invertebrates distribution in lowland rivers showed that river stretch was a more explanatory variable than habitat.

Width, depth and slope explained most of the variation and substrate type and current velocity appeared second best explanatory.

So, the question rises whether habitat configuration would not be more important than habitat itself and better fitted to earlier results. We experimentally tested if habitat configuration was related to fitness in adult river caddisflies as case. Three out of four species appeared to significantly sustain this hypothesis (Verdonschot & Verdonschot 2015). Also Rice et al. (2007) and Lancaster et al. (2006) showed that macroinvertebrates move around over the river bed and make optimal use of 3-D structures. These 3-D structures provide resilience.

Conclusions

In conclusion, the human eye does catch the organism's strategy. Therefore, ecologists should focus on much more larger scales of stretch and landscape, and take habitat configuration and 3-D habitat structural complexity into account. Further studies are needed that contribute to a better understanding of habitat fragmentation and habitat edge effects on species distribution and on the other on species dispersal capacity.

Management can improve river ecology by easy to implement measures that enhance structural complexity and configuration such as the introduction of coarse organic material (CPOM) and by adaptive maintenance of the aquatic vegetation.

References

- Leopold L.B. & Wolman M.G. 1957. River Channel Patterns - Braided, Meandering and Straight. US Geological Survey Professional Paper 282-B.
- Schumm., S. A. 1977. The Fluvial System. New York: Wiley-Interscience. 338 pp.
- Church M. 2006. Bed Material Transport and the Morphology of Alluvial River Channels. *Annu. Rev. Earth Planet. Sci.* 34: 325-354.
- Lewin J. & Brewer P.A. 2001. Predicting channel patterns. *Geomorphology* 40: 329–339. PBL, 2008
- Tolkamp H.H. 1980. Organism-substrate relationships in lowland streams. Thesis Wageningen University. 211 pp.
- Eekhout J.P.C. 2014. Morphological Processes in Lowland Streams - Implications for Stream Restoration. Thesis Wageningen University. 176 pp.
- Rice S., Buffin-Bélanager T., Lancaster J. & Reid I. 2007. Movements of a macroinvertebrate (*Potamophylax latipennis*) across a gravel-bed substrate: effects of local hydraulics and micro-topography under increasing discharge. In *Gravel-bed Rivers: From Process Understanding to River Restoration*, Habersack H, Hoey T, Piegay H, Rinaldi M (eds). Elsevier BV: Amsterdam: 637-660.
- Lancaster J., Buffin-Bélanager T., Reid I. & Rice S.P. 2006. Flow- and substratum-mediated movement by a stream insect, *Freshwater Biology* 51: 1053-1069.
- Verdonschot P.F.M. & W. Lengkeek 2006. Testing the concept of habitat dynamics. EU-FP5 project Eurolimpacs, Deliverable 95. (GOCE-CT-2003-505540 323).
- Verdonschot R.C.M. & Verdonschot P.F.M. 2015. An experimental test of the effects of substrate patchiness under different flow regimes on four lowland stream Trichoptera. Submitted to *Freshwater Biology*.

Streambed microhabitat heterogeneity as a determinant of macroinvertebrate population development

Verdonschot R. C. M. & Verdonschot P. F. M.

RALF C.M. VERDONSCHOT

Alterra, Wageningen UR, PO Box 47, 6700 AA Wageningen, the Netherlands.

PIET F.M. VERDONSCHOT

Institute for Biodiversity and Ecosystem Dynamics, University of Amsterdam, PO Box 94248, 1090 GE Amsterdam, The Netherlands & Alterra, Wageningen UR, PO Box 47, 6700 AA Wageningen, The Netherlands.

In streams hydromorphological degradation often results in a decreased streambed microhabitat heterogeneity, negatively affecting its inhabitants through interfering with, for example, resource acquisition or refuge use. To quantify these effects, it was experimentally tested if caddisfly emergence success and fitness were affected by the spatial arrangement of resource patches under different flow regimes. Larvae of *Sericostoma personatum*, *Lepidostoma basale*, *Micropterna sequax* and *Potamophylax rotundipennis* were reared together in indoor artificial recirculating channels in which leaf patches were offered on a sand bed in three spatial arrangements (fully aggregated, fragmented into three smaller isolated patches, checkerboard pattern of six small patches) under different flow regimes (constant 5 cm.s⁻¹ or 25 cm.s⁻¹ and alternating between both current velocities). The number of emerging caddisflies was counted, and for each adult fitness correlates in the form of total mass, mass of the abdomen and forewing length were measured. Microhabitat heterogeneity had clear effects on the caddisflies, but its direction and magnitude were species- and sex-specific and differed between the individual fitness correlates. Nevertheless, in three out of four species the most patchy habitat configuration yielded the highest emergence success. Flow regime was particularly important to *M. sequax*. The wide range of effects of microhabitat heterogeneity found in the experiment indicates that patchiness of the streambed is an important driver of community patterns in running waters. As a consequence, changes in substrate composition or spatial arrangement of patches due to natural or anthropogenic disturbances could have considerable effects on macroinvertebrate populations.

Introduction

Indirect effects of flow on stream invertebrates are often related to changes in substrate composition and heterogeneity of the stream bed, for example, as a result of the deposition of fine sediments during low flows or patches of coarse organic material being washed away during spates (Dewson et al. 2007, Death 2008). These disturbances lead to the redistribution of resources, changing the spatial configuration of patches within a reach. The effects such small-scale changes in habitat heterogeneity on stream invertebrates are not fully understood.

Direct tests of the importance of the spatial arrangement and configuration of resource patches for stream invertebrates are scarce, but clear effects of micro-scale patchiness on densities, emergence success and larval biomass have been reported (Palmer 1995, Palmer et al. 2000, Silver et al. 2000, Lancaster & Downes 2014). Resource acquisition

efficiency might explain the observed effects of patchy environments, besides the predation or dislodgement risk involved with inter-patch movements. In caddisflies resource deficits experienced during larval development cannot be fully overcome by adult feeding, which is often minimal or even does not occur at all (Jannot 2009). As a result, poor habitat conditions resulting from hydrologic disturbances during the larval stage could eventually lead to negative consequences on adult fitness correlates, such as reduced body size, longevity and fecundity (Beveridge & Lancaster 2007, Jannot 2009). In turn, this might affect the longer-term survival of stream invertebrate populations in disturbed streams.

To quantify the effects of spatial configuration of resource patches and the flow regime on stream invertebrate survival and fitness correlates, it was experimentally tested if: 1.) emergence success of caddisflies was affected by the arrangement of resource patches and the flow regime of the larval microhabitat, and 2.) there was an effect of patch configuration and flow on adult fitness correlates. I expected that the direction and magnitude of the response varied between species as a result of morphological, physiological and behavioural differences, for example, in traits regarding mobility, body size, habitat use and food processing rate.

Methods

In indoor artificial recirculating channels with a sandy bottom (dimensions LxWxH: 93x13.5x19 cm, filled with 10 cm deep aerated water) a fixed amount of abscised oak leaves (12 g) was offered to the larvae of four detritivorous Trichoptera species in three spatial arrangements (aggregated to dispersed; Figure 1) under three flow regimes (constant 5 cm.s⁻¹ or 25 cm.s⁻¹ and alternating between both current velocities for 3.5-day periods). This resulted in 9 treatment combinations, each replicated 5 times. Light-dark cycle in the experiment corresponded to the natural lighting conditions outside. Water temperature was kept constant at approximately 12°C, air temperature at 16°C.



Spatial configuration used in the experiment	Individual patch area (cm ²)	Total perimeter (cm)
I 	607.5	13.5
II 	202.5	67.5
III 	101.3	157.7

Figure 1. Spatial arrangements of abscised oak leaf patches (black) and sand (white) used in the experiment.

The species used were characteristic of northwestern European low-gradient, lowland streams: *Sericostoma personatum* (Sericostomatidae), *Lepidostoma basale* (Lepidostomatidae), *Micropterna sequax* and *Potamophylax rotundipennis* (both Limnephilidae). Ten larvae of each species, hand-collected in the field in the first half of

March, were released together in each of the experimental compartments at the start of the experiment. To ensure that food did not become a limiting factor, every two weeks 4 g of additional leaves was equally divided over the patches in the compartments to compensate for consumed organic material. To prevent cannibalism or predation in species which supplement their diet with (dead) invertebrates, frozen *Tubifex* worms were provided as an additional food source. In the following months the number of emerging caddisflies was counted, and for each adult fitness correlates in the form of total mass, mass of the abdomen and forewing length were measured.

After emergence, adults were collected and frozen at -18°C until further processing. I counted the number of emerging individuals (emergence success) and the number of males and females (sex-ratio) and measured the length of the left forewing, the total adult dry biomass, and the dry biomass of the abdomen. All normally distributed data was analyzed with two-way ANOVA's with both flow regime and patch configuration as fixed factors (significance level $P < 0.05$), followed by Tukey's post hoc procedures. Non-normal data was analyzed using Kruskal-Wallis non-parametric ANOVA's, with Bonferroni-corrected Mann-Whitney U-tests to examine differences between treatment pairs.

Results and discussion

There were differences in overall (all treatments combined) emergence success between species; the number of successfully emerged individuals ranged between 57% in *L. basale* and 93% in *P. rotundipennis*. The effects of the spatial arrangement of patches and flow regime on adult emergence success were species specific, but in all species except *P. rotundipennis* the checkerboard pattern of six small patches (configuration III) resulted in the highest emergence success (Figure 2). These findings are in line with the laboratory experiment of Silver et al. (2000), who found that the survival of the chironomid *Chironomus riparius* was greater in subdivided leaf patches in comparison to large aggregations of leaves.

Each of the species studied in the experiment has a preference for slowly flowing streams and the lentic zones in faster flowing streams, based on which it could be expected that a high current velocity might have a considerable impact on the larvae. Nonetheless, the occurrence of current velocities of $25 \text{ cm}\cdot\text{s}^{-1}$ only affected the emergence of *S. personatum* and *M. sequax* negatively (Figure 2). Significant interactions between patch configuration and flow regime were not found.

Potential explanations for the enhanced emergence success in a patchy environment in comparison to aggregated resources could be found in the life histories of the species. For example, the increase in *S. personatum* emergence success with patchiness could be well explained by the behavior of the larvae: it feeds on coarse organic material during the night and lives burrowed in sandy sediments at daytime (Wagner 1990). Since the increase in number of patches results in an increase in sand-leaves perimeter length, it is likely that this facilitates the efficiency of resource acquisition in this species.

Patch size and/or isolation appeared to be another relevant aspect; the smaller and completely isolated patches of configuration II yielded a lower emergence success in *L. basale* (Figure 2) and resulted in negative effects on fitness correlates in *P. rotundipennis*

males (Figure 3), as well as in *M. sequax*. This could be an indication of a lower resource acquisition efficiency in these fragmented leaf patches, possibly because inter-patch movement was impeded by the patches of sand.

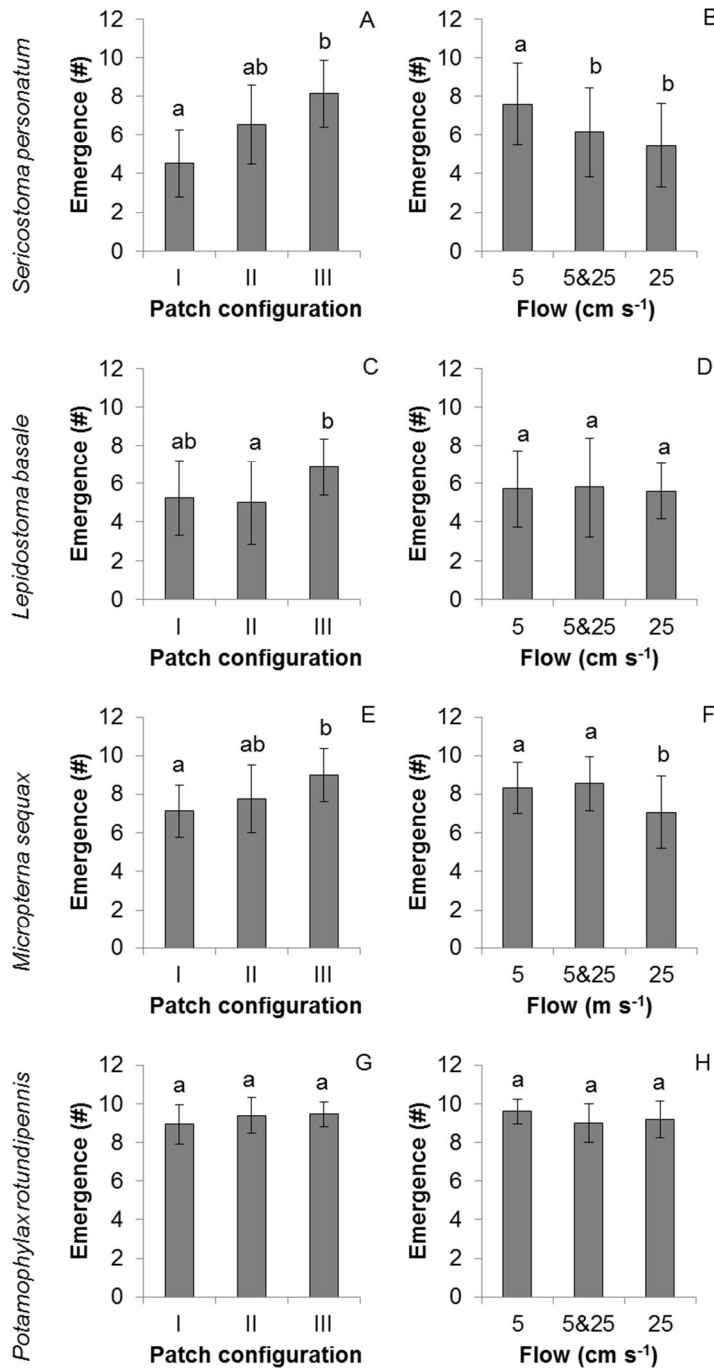

Figure 2. Comparison of the mean emergence success for the four caddisfly species in treatments with different spatial arrangements of patches (configuration I to III) and different flow regimes (constant low flow of 5 cm s⁻¹, constant high flow of 25 cm s⁻¹ and fluctuating flow alternating every 3.5 days between 5 cm s⁻¹ and 25 cm s⁻¹). Bars with different letters are significantly different.

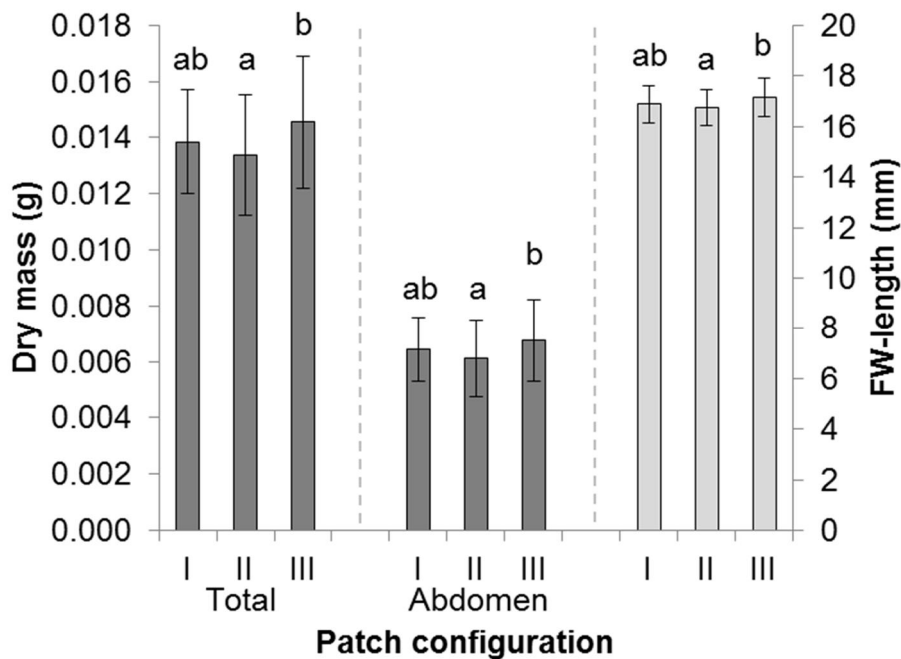

Figure 3. Mean (± 1 SD) total dry mass, abdomen dry mass and forewing length of emerged male *Potamophylax rotundipennis* in treatments with different spatial arrangement of patches (configuration I to III). Bars with different letters are significantly different within parameter groups.

Conclusions and recommendations

The wide range of effects found in the experiment, both in terms of emergence success and on fitness correlates such as body mass and wing size, indicates that small-scale heterogeneity in the form of substrate patchiness influences community patterns in streams. As a consequence, changes in substrate composition or the spatial arrangement of patches due to natural or anthropogenic disturbances could have considerable effects on macroinvertebrate populations. In the light of the lack of effects on invertebrates of numerous restoration projects aiming at the restoration of instream habitats through creating large-scale substrate and flow heterogeneity (e.g. Palmer et al. 2010, Haase et al. 2013), this study showed that it is important not to overlook the influence of mechanisms acting on the scale of the organisms.

References

- Beveridge, O.S., Lancaster, J. (2007) Sub-lethal effects of disturbance on a predatory net-spinning caddisfly. *Freshwater Biology* 52: 491–499.
- Death, R.G. (2008) The effect of floods on aquatic invertebrate communities. P. 103-121. In: Lancaster, J., Briers, R.A. (eds.) *Aquatic insects: challenges to populations*. CAB International, Oxfordshire.
- Dewson, Z.S., James, A.B.W., Death R.G. (2007) A review of the consequences of decreased flow for instream habitat and macroinvertebrates. *Journal of the North American Benthological Society* 26: 401-415.
- Haase, P., Hering, D., Jähnig, S.C., Lorenz, A.W., Sundermann, A. (2013) The impact of hydromorphological restoration on river ecological status: a comparison of fish, benthic invertebrates, and macrophytes. *Hydrobiologia* 704: 475-488.
- Jannot, J.E. (2009) Life history plasticity and fitness in a caddisfly in response to proximate cues of pond-drying. *Oecologia* 161: 267-277.

- Palmer, M.A., Menninger, H.L., Bernhardt, E. (2010) River restoration, habitat heterogeneity and biodiversity: a failure of theory or practice? *Freshwater Biology* 55, s1: 205–222.
- Palmer, M.A., Swan, C.M., Nelson, K., Silver, P., Alvestad, R.(2000) Streambed landscapes: evidence that stream invertebrates respond to the type and spatial arrangement of patches. *Landscape Ecology* 15: 563–576.
- Palmer, T.M. (1995) The influence of spatial heterogeneity on the behavior and growth of two herbivorous stream insects. *Oecologia* 104: 476-486.
- Silver, P., Cooper, J.K., Palmer, M.A., Davis, E.J. (2000) The arrangement of resources in patchy landscapes: effects on distribution, survival, and resource acquisition of chironomids. *Oecologia* 124: 216–224.
- Wagner, R. (1990) A laboratory study on the life cycle of *Sericostoma personatum* (Kirby & Spence), and light dark-dependent food consumption. *Hydrobiologia* 208: 201-212.

6. ACHIEVEMENTS BY RESTORATION AND MITIGATION PRACTICES

Effectiveness of group of pile dikes for fish habitat

Aoki M et al

Muneyuki AOKI¹, Yuta KIKUCHI² & Yoshitaka FUKUI¹

¹*Department of Civil and Environmental Engineering, Toyo Univ.,
2100, Kujirai, Kawagoe, Saitama 350-8585, Japan*

²*Course of Civil and Environmental Engineering, Toyo Univ.
2100, Kujirai, Kawagoe, Saitama 350-8585, Japan*

aoki037@toyo.jp

The purposes of this study are to examine the effectiveness of group of pile dike for fish habitat. To complete them, the experiments were done. As the results, fish move inside group of pile dikes easily, and turbulence of flow in the group of pile dikes shows spectrum with $1/f$ gradient. This spectrum with $1/f$ gradient is said be good for live. Therefore, around and in the group of pile dikes are used by fish for the potential of relaxation place, etc., because flow is providing the favorite velocity for fish.

1 INTRODUCTION

The river law of Japan was revised in 1997. As a result, water control, water utilization and river environment are considered. For river environment, it is very important to protect and preserve for eco. Additionally, implementing the nature-rich river management was required for all rivers in Japan.

In this study, the attention is focused on freshwater fish habitat and behavior in rivers. Especially, Fish behavior mainly depends on hydraulic quantity; flow velocity and water depth. Moreover, flow velocity and water depth vary depending on the presence or absence of river structures. For example, it is known groin has the hydraulic function to decrease flow velocity. There are numerous researches on hydraulic characteristics near groin. However, there are very few researches on effectiveness of groin for fish habitat. The purposes of this study are to examine the effectiveness of pile dike for fish habitat. To complete them, the experiments in small open channel were done.

2 EXPERIMENTAL METHOD

The experiments were carried out by using the small open channel in the laboratory, to measure the flow and to observe the movement of real fish. Figure 1 shows the open channel used for the experiments. The pile dike was made wooden column whose diameter is 0.5 centimeters, and was set up in the right side of the open channel. The alignment of group of pile dikes is zigzags alignment for high effect of the flow velocity decrease. Pile dikes area is $b (=8.5(\text{cm})) \times L (=192.5(\text{cm}))$ and the total number of pile dikes for each case is 122. Figure 2 shows the distribution of pile dikes in the open channel.

Table 1 shows the cases considered in the experiments. Flow quantity was changed and it experimented by six cases. $S (=4.0(\text{cm}))$ is the interval in transverse direction and $l (=4.0(\text{cm}))$ is the interval in the downstream direction.

Figure 3 shows the measurement points for hydraulics quantity. Points of x direction are $-2(\text{cm}), 0(\text{cm}), 2(\text{cm})\sim 192(\text{cm})$; each $10(\text{cm})$ and $194(\text{cm})$. Points of y direction are $1(\text{cm})\sim 11(\text{cm})$; each $1(\text{cm}), 13(\text{cm})$ and $15(\text{cm})\sim 75(\text{cm})$; each $10(\text{cm})$. The flow velocity and the water depth was measured at each point.

The real fish that used is *Tribolodon hakonensis*; figure 4 for the experiment. 10 *Tribolodon hakonensis* were used for one experiment. Those average body lengths (BL) were $5.0(\text{cm})$. These fish are common and popular in Japan. When the experiments were carried out, water temperature was $13\sim 17$ degree.

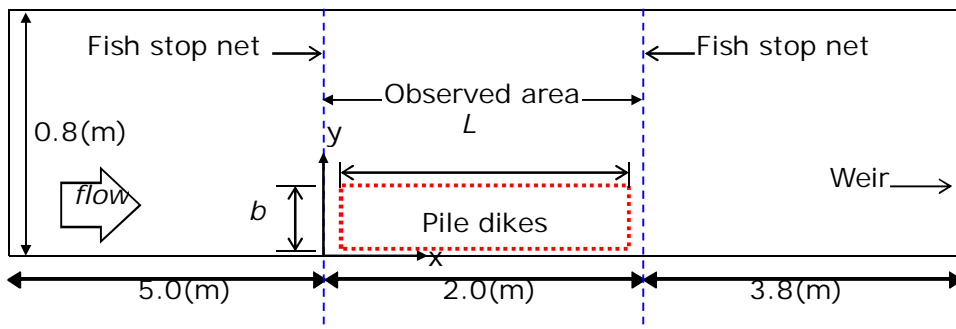

Figure 1 Plain view of open channel for experiments

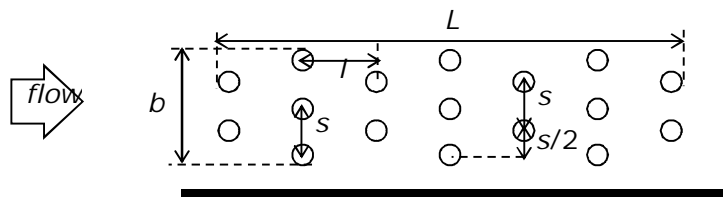

Figure 2 Distribution of pile dikes in the open channel

Table 1 Cases considered in the experiments

	Group of pile dikes	Number of pile dikes	Flow quantity (l/s)	Interval in x direction l(cm)	Interval in y direction s(cm)
Run1-1	none	-	4.0	-	-
Run1-2			12.0		
Run1-3			28.0		
Run2-1	set up	122	4.0	4	4
Run2-2			12.0		
Run2-3			28.0		

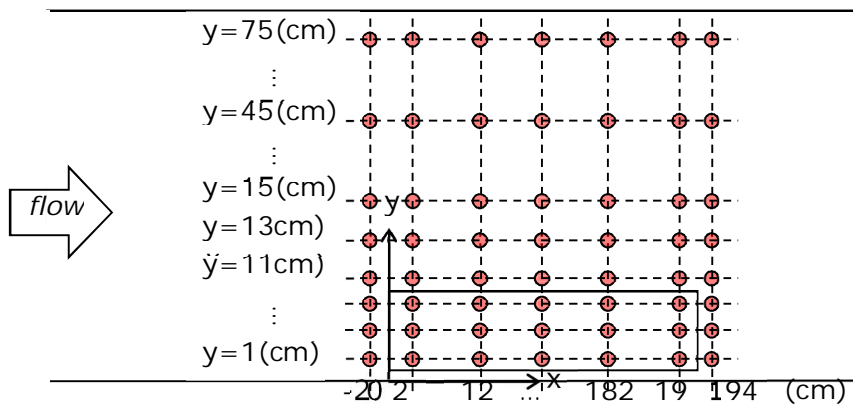

Figure 3 Measurement points for hydraulics quantities

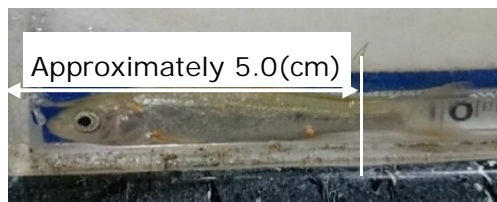

Figure 4 *Tribolodon hakonensis*

3 RESULTS OF EXPERIMENTS

Figure 5 shows the parted areas in the channel and figure 6 shows the presented ratio of fish in each area. When group of pile dikes were set up, fish move into there. Especially, the presented ratio of fish was the highest in Run2-3 ($Q=28.0(l/s)$), which is approximately 77 (%). Then, the attention is focused on turbulence of flow ($-\rho u'v'$), the FFT analysis of which was executed. Figure 7 shows the spectrum of turbulence ($-\rho u'v'$) in Run2-3. Turbulence of flow in the group of pile dikes shows spectrum with $1/f$ gradient. This spectrum with $1/f$ gradient is said be good for live. Turbulence of flow in the main stream shows $1/f^2$ fluctuation spectrum. Figure 8 shows flow velocity in Run2-3. Flow velocity was $4BL(cm/s)$ or less inside group of pile dikes. At the wall side, flow velocity was $7BL(cm/s)$ or more. Fish swam easily in the flow because cruising speed of fish was $2\sim 4BL(cm/s)$, in general. Therefore, fish entered into the group of pile dikes whose area had comfortable flow condition for them and favorite velocity condition.

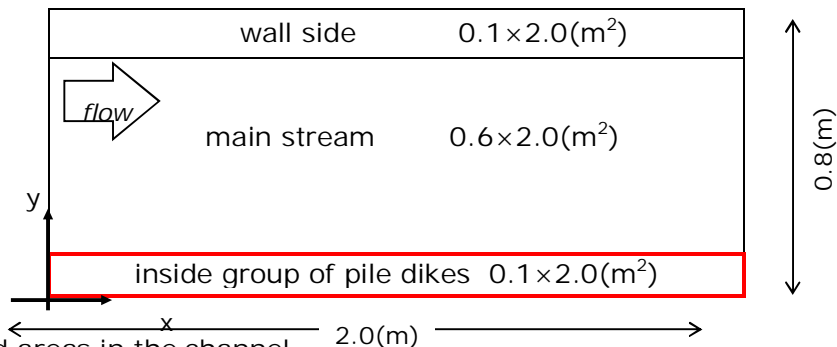

Figure 5 Parted areas in the channel

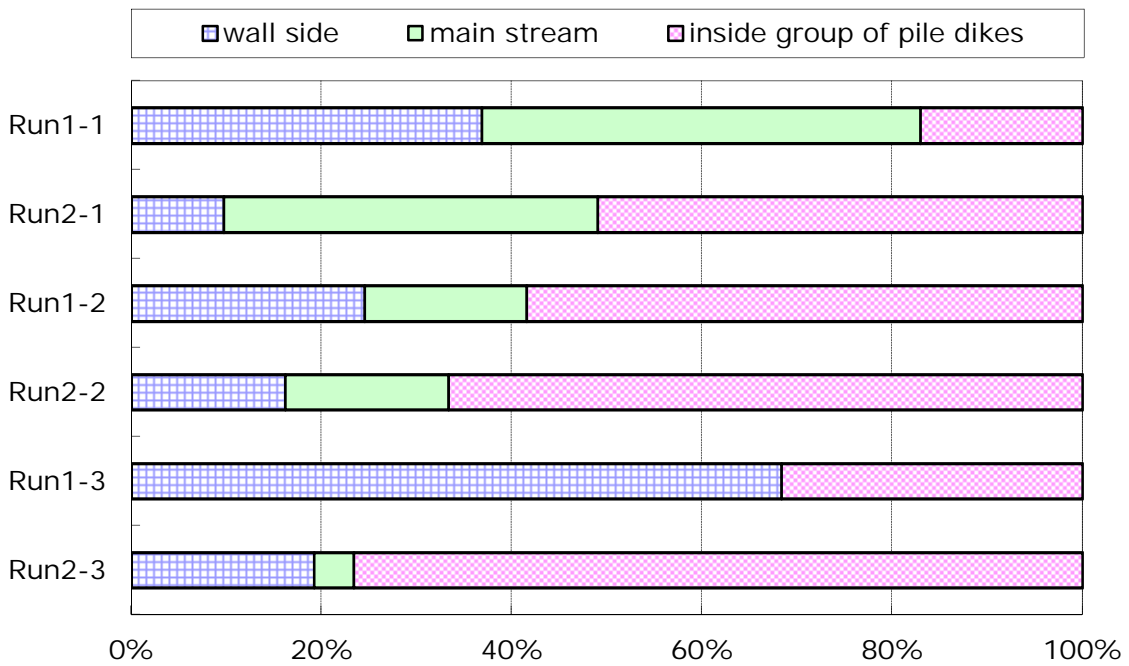
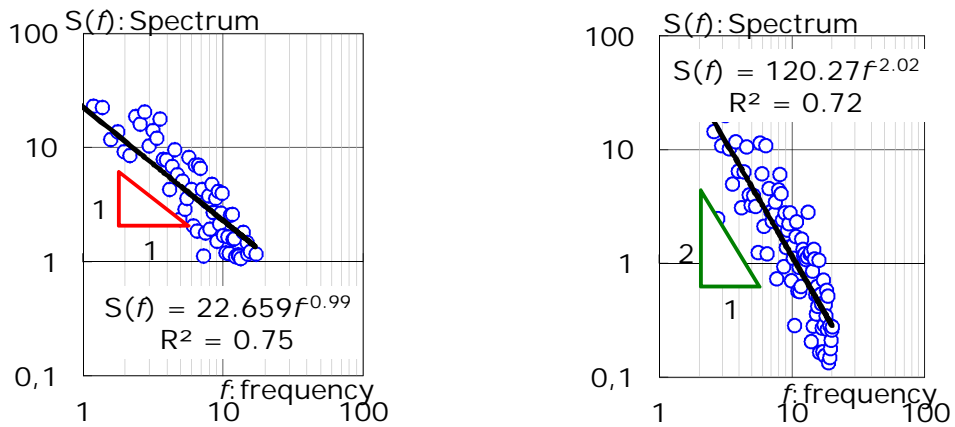

Figure 6 Presented ratio of fish in each area



a) Inside group of pile dikes b) Main stream

Figure 7 Spectrum of turbulence ($-\rho u'v'$) in Run2-3 ($Q=28.0(l/s)$)

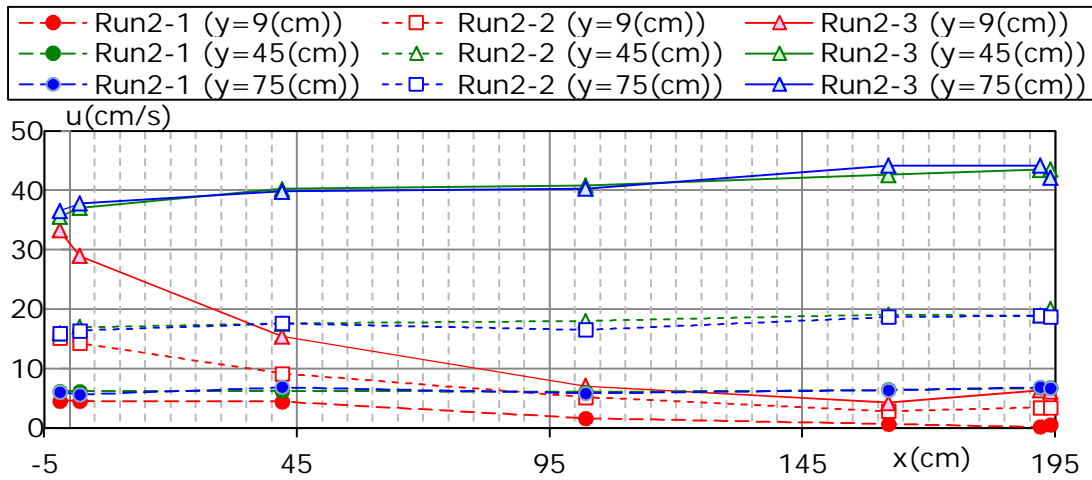

Figure 8 Flow velocity u in x direction

4 CONCLUSION

Results are shown below. 1) Fish move inside group of pile dikes easily, and turbulence of flow in the group of pile dikes shows spectrum with $1/f$ gradient. This spectrum with $1/f$ gradient is said be good for live. 2) Around and in the group of pile dikes are used by fish for the potential of relaxation, evacuation and hiding place, etc., because flow provide the favorite velocity condition for fish.

Reference

Takamizu. K., Kurihara. T., Aoki. M., Uchiyama. F. and Fukui. Y. (2007). Hydraulic functions of the pile dike and its impact on fish behavior in the vicinity. Annual Journal of Hydraulic Engineering, JSCE, Vol.51: pp.1273-1278 (Japanese)

Flow restoration of the Durance River: implementation and monitoring of targeted water releases to reduce clogging and improve river function

Beche L et al.

LEAH BÊCHE, REMI LOIRE, AGNES BARILLIER

EDF – Hydroelectricity Engineering Centre, Savoie Technolac, Le Bourget du Lac, 73373 FRANCE

JULIE MOSSERI

EDF – Mediterranean Production Unit, 10 Ave Vitton, Marseille 13482 cedex 20 FRANCE

QUENTIN DUMOUTIER

SAGE Environnement, 12 Ave du Pré de Challes, Annecy Le Vieux, 74940 FRANCE

GAÏT ARCHAMBAUD, ADRIEN MOREL

Irstea, Hydrobiology Research Unit, 3275 Route de Cézanne, 13182 Aix en Provence cedex 5, FRANCE

The Durance River is a highly regulated, gravel-bed river with a naturally high fine sediment load in southern France. EDF operates eight dams along the regulated main stream channel (218 km from the Serre-Ponçon Dam to the confluence with the Rhône River), that divert water to 16 hydroelectric power plants via a canal. Flow regulation has contributed to fine sediment accumulation (clogging) in the Durance River. In addition to a recent increase in minimum flows and in an effort to restore river function for fishes and invertebrates, EDF has implemented targeted water releases at four out of eight dams to simulate floods and reduce clogging. The timing of these releases is defined for each dam based on the spawning period of target fish species. A comprehensive long-term monitoring program has been implemented. During the release, TSS, O₂, T, H, and conductivity are measured continuously. Before and after each release, clogging (superficial/interstitial) is measured and macroinvertebrate communities are sampled. Fish (communities and target species) are sampled at least annually. Coupled with these monitoring efforts is a detailed study of biofilm and invertebrate recolonisation processes. In 2014, only two of the four releases were carried out (due to natural flooding). It was observed that TSS peaks and diminishes rapidly during these releases. Superficial clogging was reduced (when release flows were sufficient), whereas O₂, interstitial clogging and macroinvertebrate communities remained relatively unchanged. Flow releases and monitoring will continue for several years, which will be necessary to evaluate the flow restoration efficacy (especially for fish populations).

Introduction

Large-scale flow experiments are becoming more common as an increasing focus on improving aquatic habitat quality and regulatory pressures incite dam operators to partially restore natural flow regimes (Olden et al. 2014). Flow regime restoration can take many forms: establishing minimum environmental flows, reintroducing natural variability, clear water releases, or a combination of measures.

Mediterranean rivers are characterized by their seasonal flow regime, with flooding in winter and spring and low base-flows during summer. In South-Eastern France, the Durance River, a Rhône River tributary, has a highly altered flow regime resulting from extensive hydropower production and other water uses (e.g. irrigation). Eight dams are present on the Durance, creating several bypassed reaches, with most of the water flowing into canals parallel to the bypass channel. With the exception of the most upstream dam, Serre Ponçon, peak floods regularly exceed dam capacities and spill into the bypassed (i.e. minimum-flow) reaches.

Because of the naturally high fine sediment load in the Durance River (inputs from torrential tributaries), unpredictable high flow events (dam overflow) are not always sufficient to reduce clogging, which has led to habitat degradation in bypassed reaches. Therefore, in addition to a regulatory increase in minimum flows (as of January 2014), EDF is conducting a large-scale flow experiment, in the context of adaptive management, to test the efficacy of clear-water releases to restore benthic habitat conditions (reducing clogging) prior to spawning periods. Four reaches are targeted by these releases, downstream of the following dams: Espinasses, La Saulce, l'Escale and Cadarache (Figure 1).

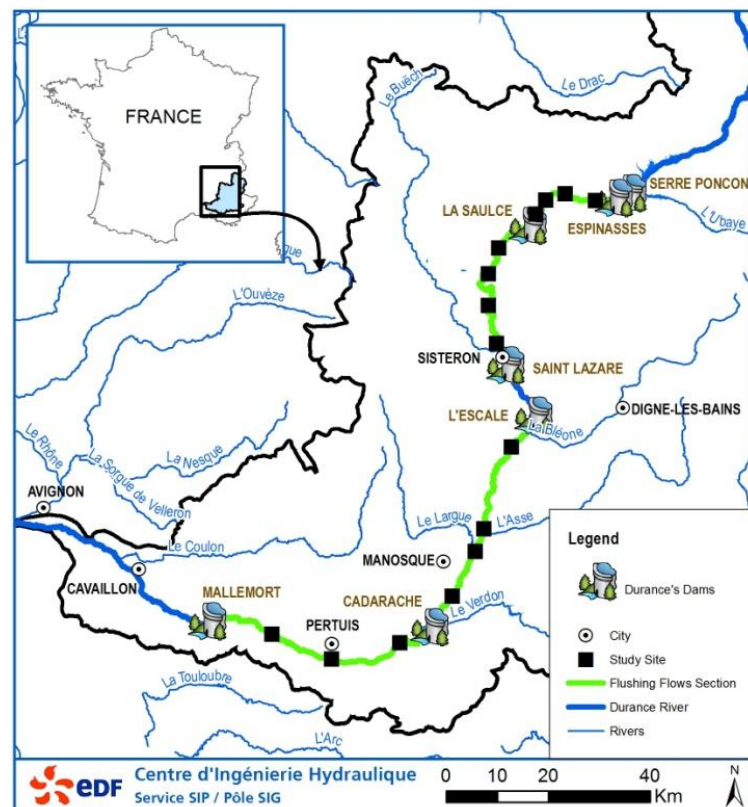

Figure 1. The Durance River in France: reaches where clear-water releases are being experimented (flushing flows), dams and study sites.

Restoration objectives

Studies conducted prior to the increase in minimum environmental flows (MEF) illustrated a high level of clogging in many reaches, which was identified as a limiting factor for

invertebrate community development and fish reproductive success. Therefore in addition to increasing MEF (1.5 to 2 fold), clear-water releases were proposed to reduce benthic sediment clogging and restore habitats for targeted fish species immediately prior to spawning (Table 1).

Previous experiments demonstrated that reclogging (or surface fining) can occur soon after clear-water releases; therefore, the target period for releases is as close as possible to the onset of spawning activity of each target fish species (and a second release may also be conducted in some reaches). Given the experimental nature of these restoration measures, EDF committed to conducting annual clear-water releases for an initial period of 3 years, after which their efficacy will be evaluated to adapt future flow management.

The flow necessary to initiate fine particle movement without resulting in generalised sediment transport (of larger particles) was estimated by expert opinion and the analysis of a few historic events. This flow value will be adjusted according to monitoring results. However, release flows should not result in flooding of key zones (namely agricultural fields and levees). The volume of water released must also be calculated such that the water level rises progressively for security reasons, but also to ensure that fine sediments are entirely displaced to the most downstream portion of each reach.

Table 1. Clear water release characteristics for each reach. MEF represent 5% of the mean annual flow (except downstream of the Escale dam from April – September, where it represents 7%).

Dam	Target species	Clear-water release period	MEF (m ³ /s)	Release flow (m ³ /s)	Release duration (maximum flow)
Espinasses	Fario trout	15 Nov – 01 Jan	4.1	40	10 hr (~6 hr at the reach end)
La Saulce	Apron	01 Jan – 15 Feb	4.4	60	
Escale	Rheophilic cyprinids (+Apron)	01 Feb – 15 Mar	6.1 – 8.7 (Oct-Mar; Apr-Sept)	70	
Cadarache	Rheophilic cyprinids	01 Apr – 15 May	9	70	12–13 hr (4–6 hr at the reach end)

Monitoring programme

To evaluate the effectiveness of the restoration measures (releases and MEF), an ambitious monitoring programme spanning at least 3-6 years has been implemented, targeting every major component of the aquatic ecosystem. Rather than seeking to detect statistically significant changes in the various parameters, the monitoring program is aimed at determining whether ecological objectives (cf. Table 1) have been met. Two monitoring objectives are targeted: (1) to directly evaluate the effectiveness of the releases (with respect to reduced benthic clogging) over a period of at least 3 years and (2) to evaluate the overall effectiveness of flow restoration measures on biota over a period of at least 6 years.

To monitor the efficacy of releases (objective 1), continuous measurements of water depth, TSS, turbidity, conductivity, temperature and dissolved oxygen are conducted during the release. Clogging (surface and interstitial) is measured 15 days prior to the release, the day after the release and 1-month post-release. Sampling of macroinvertebrate communities (15 days before and 1-month after release) is also conducted. All measurements (continuous or punctual) are taken at 3 – 4 approximately equidistant stations.

Surface clogging is evaluated visually using a semi-quantitative scale designed to describe the level of substrate embeddedness (Archambaud et al. 2005). Interstitial clogging is evaluated using a measure of hydraulic conductivity (Datry et al. In press). Particle size distribution is evaluated using the Malavoi and Souchon (1989) method (a semi-quantitative adaptation of the Wentworth scale). Substrate measurements are conducted at 30 points distributed among 5-6 transects per station, placed such that they represent a succession of lotic habitats and correspond to potential fish spawning habitats. In addition, two topographic profile surveys (cm precision) are conducted at each station before and after each release to monitor small changes in channel morphology following releases and over several years.

For the second objective, the monitoring program varies as a function of target species and specificities of the reach. In each reach, flow, temperature, channel morphology (yearly orthophotos) and fish populations are monitored. Where trout are targeted (Espinasses), spawning redds are mapped and YOY populations are estimated with specific electrofishing techniques. In the two reaches with apron populations, specific inventories are conducted in riffle habitats.

Downstream of the Escale dam, a specific study on the recolonisation dynamics of biofilm and invertebrate communities is being conducted, with high-frequency sampling (pre- and post-release). Furthermore, downstream of Cadarache, where there are many gravel bars, bird nesting and habitat quality is also monitored (in particular for the little ringed plover and the common tern).

Initial results

Of the four programmed releases in 2014, only two were undertaken: at La Saulce on February 4th and at Espinasses on November 14th. The other two releases were cancelled because of a large flood event that occurred late January ($>1200 \text{ m}^3/\text{s}$).

Despite having placed the stations equidistant from each other, the propagation time for the release differs substantially among stations: from 30 min to 1.5 h (5 to 12 km/h), with little attenuation of the peak flow over several dozen kilometres, demonstrating that the pulse was hydraulically effective.

Total Suspended Solids

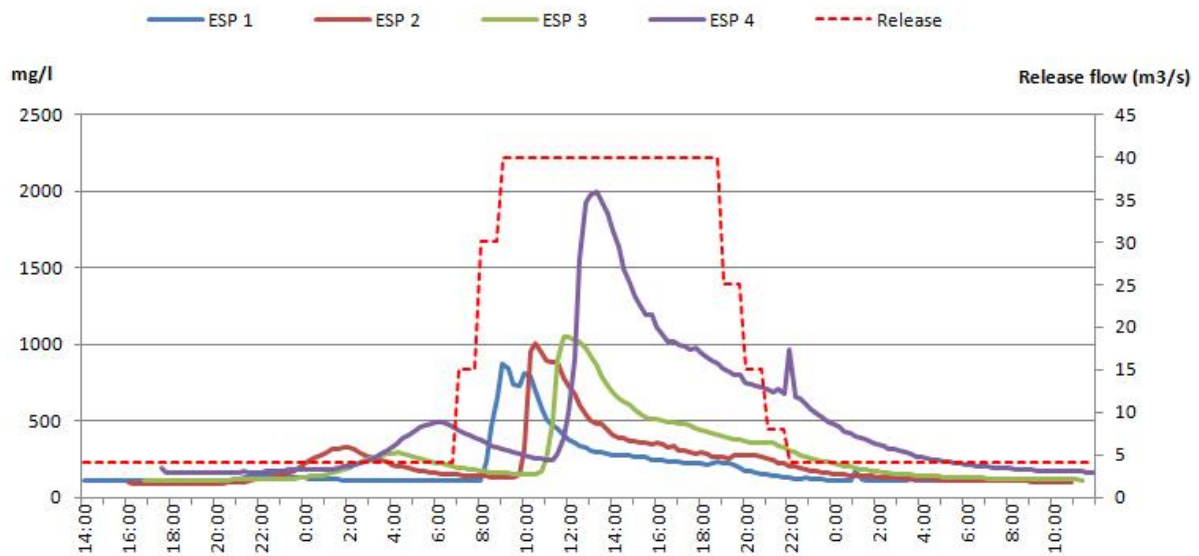

Figure 2. Release flow and TSS at each station (Espinasces, Nov. 14, 2014).

During the release, water temperature increased by several degrees as the release delivered warmer surface water from the reservoir. Conductivity varied little during the release and dissolved oxygen was unchanged. The effect of the release on sediment transport (large particles) was insignificant. The minor changes observed in size distribution and morphology are likely due to the influence of inputs from torrential tributaries (localised rain events). The release had a greater influence on fine sediment transport, which was observed as soon as the release began (Figure 2).

Suspended solid concentrations decreased rapidly to only 30% of the peak concentration despite a constant release flow. A mechanism of progressive erosion was observed (the volume of mobilised sediments increased downstream). The release was a success from a hydraulic perspective; future experiments will be conducted to determine whether the release duration can be shortened and still obtain satisfactory results.

Despite substantial fine-sediment transport, considerable surface clogging was still present at three of four stations post-release (a majority of habitats are > 75% clogged) and clogging systematically increased between the second and third campaigns (all habitats combined). The reasons for the persistent clogging cannot yet be determined as several rain events just prior to the release make it difficult to determine whether only a portion of the fines were mobilised or whether there was a rapid redeposit of fines (from tributary inputs).

Clogging of trout spawning habitats, was, however relatively low (< 50%) at most of the sites, even 6 weeks after the release (spawning began approximately 1 week after the release). These results suggest that trout are actively selecting the least clogged habitats for spawning (which represent less than 30% of lotic habitats available). Interestingly, the site with the highest level of clogging post-release also had the greatest number and

density of redds. Future surveys will specifically study trout spawning habitat preferences as a function of fining and clogging.

The effectiveness of the La Saulce release in February 2014 (aimed at improving apron spawning conditions) was also mixed, even though benthic clogging was more clearly reduced for the habitats with > 75% clogging prior to the release. Apron reproduction (as measured by 0+ individuals captured in summer) was relatively low (compared to previous years). Even though invertebrate metrics did not change post-pulse, there was a substantial decrease in the abundance of species preferring slow current habitats (for example, *Caenis pusilla* and *Gammarus* sp.).

Although no experimental release was conducted at the Escale dam in 2014, the biofilm and invertebrate recolonisation study was carried out following the large (morphogenic) flood in January, which will allow for a comparison of flood and release effects on recolonisation dynamics (e.g. Robinson 2012). In particular, a species (*Alainites muticus*) that lives exclusively in the interstitial space between cobbles (thus in unclogged habitats), was observed at every sampling date. The presence of this species (as well as *Oligoneuriella*), can therefore be used as an indicator of unclogged habitats for future release experiments. A clear succession of different species of Ephemeroptera (namely *Acentrella sinaica*, *Baetis fuscatus* and *B. buceratus*) was observed. Biofilm results will soon be used to the influence of biofilm development (production and species composition) on these dynamics.

Conclusion

While the planning phase for experimental releases and the associated monitoring program is relatively straight-forward, the actual implementation of releases remains challenging. For example, the release flows are relatively low and even small precipitation events can result in flows close to the planned release. When these events occur prior to a planned release, evaluating the efficacy of the natural event on clogging objectives is often complicated because river access can be dangerous or visual measurements impossible (poor visibility). Cancelling a release based on prior "high" flow events can therefore be a difficult decision to make. Furthermore, in warm years, such as 2015, temperature can become a critical element to determine the appropriate release period (if the release is too late it could perturb spawning), which necessitates real-time temperature monitoring, as well as for the dam operator to have a certain flexibility in the timing of the release. Releases are often conducted during periods of high electricity demand; it can be difficult to allow for such flexibility in release timing.

The results from the pluriannual monitoring program will allow for the releases to be adjusted (adaptive management) if needed to meet the ecological objectives. Certain adjustments to the monitoring protocol may also be made (more frequent invertebrate sampling, separating fining and clogging assessments, etc.) to improve the evaluation of release effects.

References

Archambaud, G., Giordano, L., Dumont, B. (2005). Description du substrat minéral et du colmatage. Note technique provisoire. CEMAGREF Aix en Provence. 7p.

- Datry, T., Lamouroux, N., Thivin, G., Descloux, S. Baudoin, J.M. in press. Estimation of sediment hydraulic conductivity in river reaches and its potential use to evaluate streambed clogging. *River Research and Applications*.
- Olden, J.D., Konrad, C.P., et al. (2014). Are large-scale flow experiments informing the science and management of freshwater ecosystems? *Frontiers in Ecology and Environment* 12: 176–185.
- Malavoi, J.R., Souchon, Y. (1989). Méthodologie de description et quantification des variables morphodynamiques d'un cours d'eau à fond caillouteux. Exemple d'une station sur la Filière (Haute Savoie). *Revue de Géographie de Lyon* 64: 252-259.
- Robinson, C.T. (2012). Long-term changes in community assembly, resistance, and resilience following experimental floods. *Ecological Applications* 22: 1949–1961.

Ecological aspects of fluvial processes recovery at Becva River

Brabec K et al.

BRABEC K.¹, JURAJDA P.², KALIVODOVA M.¹, KOHUT L.¹, BRABCOVA B.³, HAJEK O.⁴, KOMPRDOVA K.¹, STIKOVA K.⁴, BABEJ J.⁵, VESELY D.⁶, ZACHOVAL Z.⁷, SYROVATKA V.⁴, OPATRILOVA L.⁸, FILIPPOV P.

¹ *Research Centre for Toxic Compounds in the Environment, Faculty of Science, Masaryk University, Kamenice 753/5, 625 00 Brno, Czech Republic*

² *Institute of Vertebrate Biology of the ASCR, v. v. i., Kvetna 8, 603 65 Brno, Czech Republic*

³ *Department of Biology, Faculty of Education, Porici 7, 603 00 Brno, Czech Republic*

⁴ *Department of Zoology & Ecology, Faculty of Science, Masaryk University, Kotlarska 2, 611 37 Brno, Czech Republic*

⁵ *Department of Geography, Faculty of Science, Masaryk University, Kotlarska 2, 611 37 Brno, Czech Republic*

⁶ *Morava River Board s.e., Drevarska 11, 602 00 Brno, Czech Republic*

⁷ *Institute of Water Structures, Faculty of Civil Engineering, Brno University of Technology, Veveri 95, 602 00 Brno, Czech Republic*

⁸ *T. G. Masaryk Water Research Institute, Podbabska 2582/30, 160 00 Praha, Czech Republic*

Flood-induced renaturalization of the Becva River segments was studied applying multidisciplinary approach. Ecological linkages among channel units and stream biota (macroinvertebrates, algae, fish) were identified. Specific macroinvertebrate taxa and community characteristics were found for four types of river habitats (channel units). Based on a position in the channel and using hydraulic thresholds a distinction was made among riffles and pools in central part of the main channel, marginal zone of the main channel and lateral arms/pools. Differentiation of stream biota between central-channel and lateral habitats was related to the degree of their isolation (connectivity of side arms).

Partial recovery of channel forming processes, increased bank zone heterogeneity, temporal occurrence of large woody debris in the channel and formation of lateral channels/pools characterized renaturalization process of the Becva River at the studied segments.

Introduction

Knowledge of hydromorphological processes in a gravel-bed river and ecological consequences of seasonal or discharge-related dynamics of fluvial system is crucial for evaluation of restoration effects in streams. Development of biological indicators responding to physical changes of channel allows identification of restoration effects under multiple stress conditions. Study aims were to support planning of river restoration by developing efficient monitoring strategies (sampling design – habitats, seasons; indicators; survey methods), to develop hydraulic models and to analyze biological response to instream changes.

Studied sites

The Becva River as a tributary of the Morava River is a part of the Danube River Basin. Mean annual discharge at the gauging station in Dluhonice is $17.3 \text{ m}^3 \text{ s}^{-1}$. Sampling was done at two gravel-dominated river stretches of seventh Strahler stream order.

Within the 61 km long Becva River (from confluence of the Vsetinska Becva and Roznovska Becva rivers to confluence with the Morava River) there were five stretches renaturalized. Studied renaturalized stretches of the Becva River (up to 1 km long) at sites Cernotin and Osek are surrounded by straightened channel with fixed banks.

Selected results

Environmental characteristics

Discharge regime of the Becva River is highly variable due to predominating flysch geology causing low water retention in the catchment. Flow and sediment regimes are almost unaffected by dam operation (there are only two small reservoirs in the catchment).

Daily ranges of water temperature were 0.8°C in the side pool and 4.8°C in the main channel (mean values for a period of March-September 2007). Spring-summer mean temperature in the channel was higher (17.4°C) than in the side pools (13.3°C). Winter temperatures exhibited inverse pattern between these habitats. It was found also that there was a substantial difference in dissolved oxygen content in water of the main channel (12.4 mg.l^{-1}) and in the side pools (3.3 mg.l^{-1}) in May. The side pools were fed by groundwater and interstitial water flowing through a gravel bar.

Habitat classification

In comparison to a regulated river channel new types of habitats occurred at the restored stretches. Marginal pools, vegetated and bare gravel bars or woody debris patches were habitats contributing to overall habitat heterogeneity. Additionally, groundwater discharges affecting mainly the marginal zone were reflected in increased thermal heterogeneity within the stream channel.

Habitats were classified based on a position in the river channel and local hydraulic characteristics. These functional habitats were characterized by a certain degree of environmental stability. Central-channel habitats were categorized by applying Jowett's (1993) criteria for objective distinguishing of riffles, runs and pools based on Froude number and/or velocity/depth ratio. Riffles and runs were merged into a single category.

Hydraulic model

2D numerical model of shallow water flow was performed by SMS Software 9.2 - FESWMS. The ground surface was created by triangulation with using the measured data, the roughness was preliminarily determined from the grain size of the bottom cover layer. Model calibration was performed based on the measured depth and point velocities at three discharges and verification of the model on the shape of bank lines at known discharges. The calculation was performed for seven discharges. The outputs of the models were maps of the water surface level, maps of the depth and maps of the velocities. Calculation was made of maps of shear stress at the bottom and maps of

Froude number. This allowed to model spatial extents of hydraulically defined habitats within existing hydromorphological conditions of the river channel.

Algae

Algal communities were studied focusing on spatial distribution in the main channel habitats and the side pools. A specific study was conducted comparing phytobenthos communities at different types of substrates in the main channel (particle size, stability). Number of phytobenthos taxa was relatively similar among substrate types (microlithal, mesolithal and large stones used for bank fixation - technolithal). It ranged between 25 and 35 taxa, except lower values observed at microlithal in July (20) and at technolithal in October (14). Substantial temporal changes in community structure were found among May, July and October sampling dates. Overall diatom predominance in a number of taxa and quantity was lowered in samples taken in October by development of coccal green algae (e.g. *Scenedesmus* spp.).

The study comparing composition of algal communities among the side pools was based on monthly samplings in a period of May-August 2005. Cluster analysis based on Bray-Curtis dissimilarity showed higher difference among seasons than habitats.

Macroinvertebrates

Taxonomic structure of macroinvertebrates from the channel margin and side arms/pools clearly differed from those inhabiting the main-channel habitats. The main-channel communities differed among habitats more in autumn than in spring. High and variable flows during spring increased spatial homogeneity and temporal variability of the river habitats. Environmental history of habitats affected the structure of macroinvertebrate communities.

Taxa and community characteristics specific for individual habitat types were distinguished. Side arm habitats (S_POOL) were characterized by stagnant flow conditions for most of the year reflecting in fine sediments and specific thermal and water chemistry conditions associated with groundwater fluxes. The most distinctive indicator taxa for this habitat type were *Chironomus* spp., *Cloeon dipterum* and *Acricotopus lucens*.

Marginal zones of the main river channel were affected by interactions with terrestrial habitats (e.g. living parts of terrestrial plants, POM source) and interacting sedimentation regime. Marginal habitats with a high sedimentation rate were characterized by a high FPOM proportion in the surface sediment layer, low current velocity and high densities of *Caenis* spp. (autumn), *Oligochaeta* (spring) and by several indicator taxa (e.g. *Dicrotendipes nervosus*-Gr., *Paratanytarsus* sp., *Gammarus roeselii*, *Micronecta* sp., *Gomphus vulgatissimus*).

The main-channel habitats classified by hydraulic factors were inhabited by communities less specific to a certain type, but some community characteristics (e.g. proportions of feeding strategies) exhibited relationships to physical gradients. Indicator taxa and patterns of relationships between environmental and biotic parameters were frequently specific to river segments and seasons. Riffles with Froude number higher than 0.41 were

characterized by specific fauna resulting in well separated clusters in multivariate analyses based on community composition.

Results confirmed the importance of rare habitats as an element causing the increase of biological diversity of the river reach, regardless of the potential importance of these habitats as the refugium for many invertebrates during spates.

Fish

Taxa richness and total fish abundance at the restored river stretch exceeded regulated stretch of the Cernotin site. This was caused mainly by high number of taxa found at habitats associated with fallen trees (5-7 species) at the restored stretch and low taxa richness (3-4 species) at the riprap zone of the regulated stretch. Fish communities of riffles did not differ between the restored and regulated stretches.

Preliminary conclusions

- season is more important for the structure of phytobenthos and macroinvertebrate communities than a river stretch or habitat characteristics
- distributional patterns in autumn (stable low discharge) are more distinct than in spring when recolonization processes after high flows interact with habitat preferences
- habitat typology was proposed and its relevance for biological communities was evaluated
- habitat-specific relationships between hydraulic variables and trait-based characteristics of benthic communities were found (specific also to river stretch)

Acknowledgements

Research leading to the presented results was supported by the EU's FP7 under Grant Agreement No. 282656 (REFORM). The RECETOX research infrastructure was supported by projects of the Czech Ministry of Education (LO1214 and LM2011028).

References

- Jowett, I. G., 1993. A method for objectively identifying pool, run, and riffle habitats from physical measurements. *New Zealand Journal of Marine and Freshwater Research* 27: 241–248.
- Kubosova K., Brabec K., Jarkovsky J., Syrovatka V., 2010: Selection of indicative taxa for river habitats: a case study on benthic macroinvertebrates using indicator species analysis and the random forest methods. *Hydrobiologia* 651 (1): 101-114.
- Syrovatka, V. & Brabec K., 2010. The response of chironomid assemblages (Diptera: Chironomidae) to hydraulic conditions: a case study in a gravel-bed river. *Fundamental and Applied Limnology, Archiv für Hydrobiologie*, 178(1): 43-57.

Woody debris increases macroinvertebrates communities in stream construction works

Brugmans et al.

BART (B.T.M.J.) BRUGMANS¹, MIEKE (M.) MOELEKER¹, ELLEN (E.J.) WEERMAN² & RIMBAUD (R.E.) LAPPERRE¹

¹Water board Aa and Maas

Pettelaarpark 70, 5216 PP, 's-Hertogenbosch, the Netherlands

²HAS Hogeschool, University of Applied Sciences

Onderwijsboulevard 221, 5223 DE, 's Hertogenbosch, the Netherlands

Stream restoration and rehabilitation to increase biological water quality has become a priority task for authorities to comply with the European Water Framework Directive. In the past, most streams have been canalised by placing weirs resulting in a uniform flow rate, which is unfavourable for macroinvertebrates diversity. One method to increase the water flow velocity is to fix woody debris into the streambed. Woody debris will lead to increased habitat heterogeneity by causing variable water flow velocities. Theory predicts that increased habitat heterogeneity increases and stabilizes associated macroinvertebrates diversity. In the "Snelle Loop", a stream in the south of the Netherlands, a weir was removed and replaced with 10 constructions of woody debris to increase water level and the variety in flow rate over a course of 1, 2 kilometre. Hydrodynamics, water quality and macroinvertebrates communities were measured twice a year for the past three years. Removal of the weir caused a water level decrease of 50 cm, whereas the introduction of 10 woody debris constructions compensated for the water level decline. The input of woody debris also resulted in increased habitat heterogeneity and increased macroinvertebrates diversity. Surprisingly, already within a year after appliance of the woody debris, macroinvertebrates species indicative for healthy streams were found. During the following sampling periods the same and even more species specific for healthy stream ecosystems were found. For example, the red list species *Goera pilosa* was found half a year after the weir was replaced by woody debris. Macroinvertebrates diversity seems to be higher near patches with coarse materials (such as gravel) as substrate and high habitat heterogeneity. Results from this study show that woody debris can be a successful and cost-efficient natural replacement of weirs and leads to increase substrate heterogeneity and macroinvertebrates diversity.

Introduction

Over two decades ago, a plan was presented to reconstruct a stream, the 'Snelle Loop' (Figure 1), in the south of the Netherlands (H2O magazine, 1991, no. 5). The researchers noticed that canalization and weirs in the stream led to a uniform flow resulting in low oxygen levels, and very little variation in food supply and substrate types. These circumstances are unfavourable for the development of macroinvertebrates diversity, typical for a lowland stream. In the article, two important characteristics for a natural lowland stream were mentioned: the food gradient in the cross sections and the presence of wood. In the stream 'Snelle Loop' both characteristics were missing and had a direct impact on the diversity of macroinvertebrates. Moreover, regular mowing of the banks by cutting vegetation and removing pieces of wood and trees led to a substantial

impoverishment of macroinvertebrates diversity. The researchers made recommendations for a more natural design of the stream. Also because of the Water Framework Directive, the water board Aa and Maas, the municipality of Gemert-Bakel and a local land owner made an agreement in 2006 and formed a joint investment and maintenance fund to put these recommendations into practice. That gave an opportunity to bring the stream restoration of the "Snelle Loop" into an implementation program. Within this program, a special pilot project was started in the "Snelle Loop", with the aim of restore a stream with the input of woody debris. After careful preparations, a weir was removed and at 10 places woody debris were placed into the stream. Each construction was designed and placed in a different way in the stream.

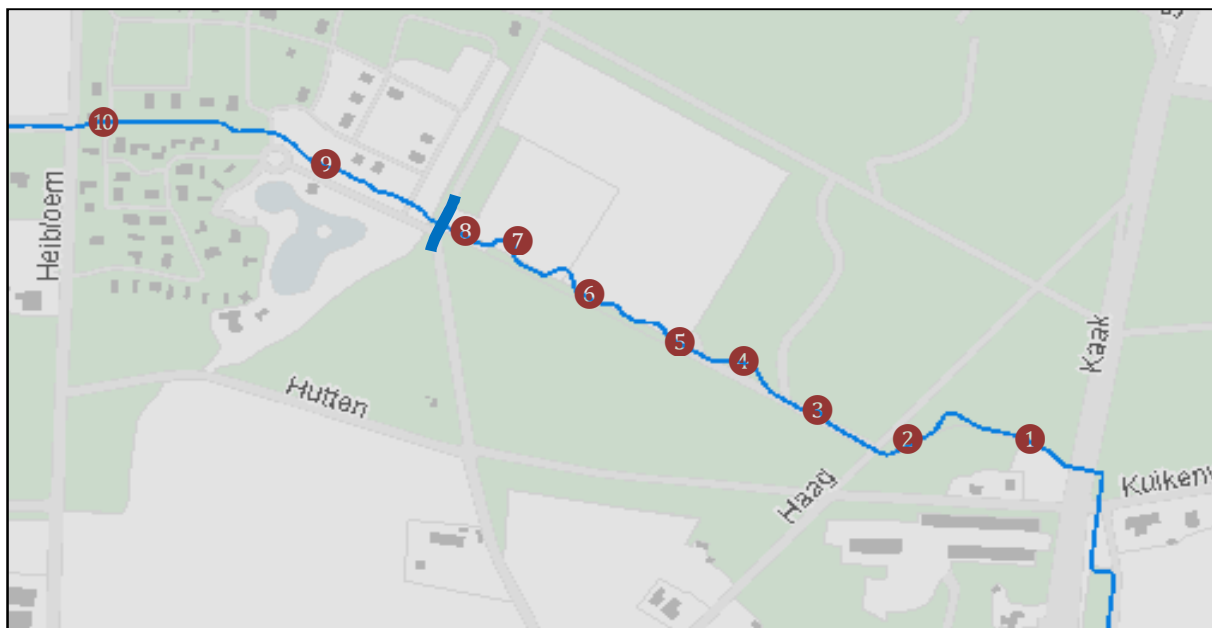

Figure 1: The 10 wooden constructions (in red) and removed weir (in blue) in the "Snelle Loop"

Because this project is an example for other streams, the effects on hydrology, macroinvertebrates, and substrate types were monitored. The hydrological effects were examined by the water board Aa and Maas. For macroinvertebrates and hydromorphology, the water board is supported by students of the HAS University of Applied Sciences in 's -Hertogenbosch and their scientific supervisors.

Effects on hydrology: water levels

When monitoring the hydrological effects, the original situation was compared with the new situation with 10 different wood structures. Each of these wooden structures is unique and is expected to have a different hydrological effect. Hydrological monitoring focused at the change in water levels, and differences in velocities and water depths. At the affected part of the stream, eight different wooden structures (numbers 1 to 8) were designed and installed in the spring of 2012. Simultaneously, two wooden structures (numbers 9 and 10) were installed downstream of the original weir (figure 1). By removing the original weir, the upstream water level was reduced by approximately 50 cm at the weir position. The combined hydrological effect of placing the wooden structures, was an incline in water level ranging from 34 to 51 cm and depended also on the discharge and the presence of wood and leaves. The average effect on the water

level is approximately 43 cm and approximates the effect of the removed weir. The effect by each wood construction varied. Wood constructions 4, 5, 6 and 7 had a small effect, which varied from 1 to 3 cm water level increase. Wood constructions 1, 2 and 3 had a larger effect on the water level, that varied from 3 to 8 cm. Wood construction 8 had the biggest effect to approximately 19 cm. The constructions and their effect variation on hydrological and substrate characteristics are presented in figure 2.

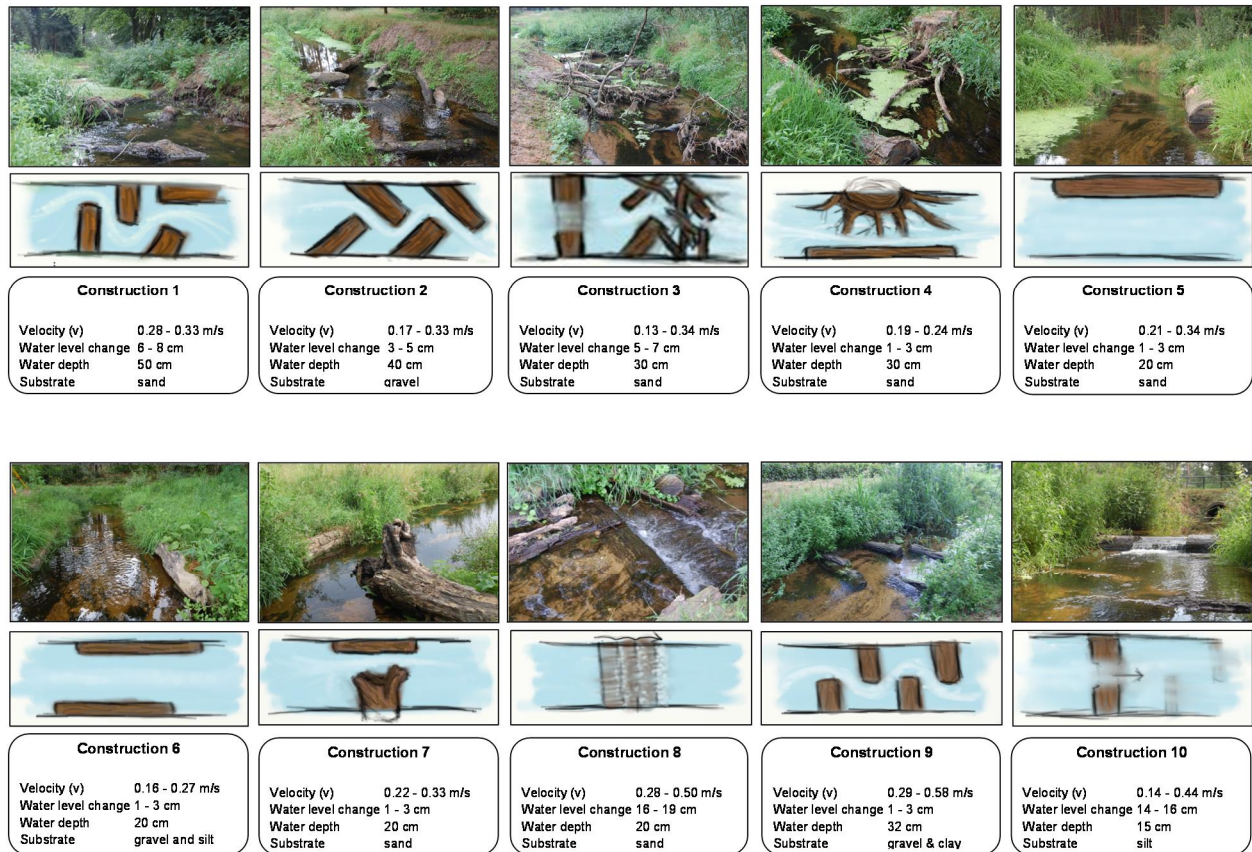

Figure 2: Wooden structures and variations in hydrological and substrate characteristics

Effects on hydrology: water velocity

The average velocity before removal of the weir was approximately 0.15 m/s (range: 0.10 to 0.20 m/s). After the introduction of the 10 woody constructions, the flow rate was measured again 5 m upstream, in the centre and 5 m downstream every construction. The measurements were performed three times in the period 2012-2013.

The main results are:

The velocity upstream most wooden constructions has been unchanged: 0.10 to 0.20 m/s. The velocity in the middle of each construction is higher, up to a factor 2 compared to the upstream measurements.

For wood constructions 8, 9 and 10 the accelerating effect is greater and increases with a factor of 5.

For wood constructions 1, 2, 6 and 9 immediately after the construction one or more deep holes appear, in which sand is washed away and a gravel bed has become visible (figure 3).

The applied wood structures together have a sufficient effect at the water level to compensate for the removal of the weir. In addition, the wood constructions have positive effect on the velocity (and create a variety in water depth).

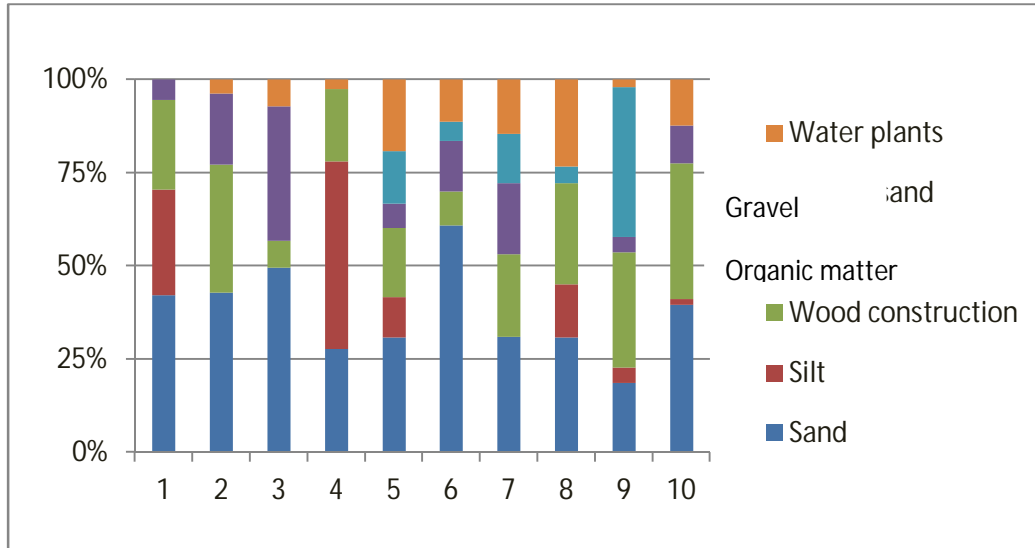

Figure 3: Substrate heterogeneity of the 10 wooden constructions (Measured in spring 2014).

Effects on biology: macroinvertebrates

Ecological water quality is determined on the basis of a rapid reproducible method for the assessment of macroinvertebrates (GTD method). At every construction, the sampled species were counted, and identified to species or genus level by eye (which means only huge differences are counting for another specie/genus). The different taxa are counted and divided into group A, B or C. A-group species are characteristic for lowland streams. C-group species are the ubiquitous and general species. B-group species are in between A and C. In order to qualify the ecological water quality, the number of A, B and C species per wooden construction is pooled and classified according to table 1. The ecological water quality before placing the wooden structures was classified as Level 2: Base level (Measurements April 2012, figure 4).

Table 1: Ecological water quality qualification used in this study

Level	Calculation	Explanation
1.	Group A + B ≥ 20 & group A ≥ 5	Higher level for streams
2.	Group A + B + C ≥ 20	Base level
3.	Group A + B + C ≥ 10	Moderate disturbance
4.	Group A + B + C < 10	Serious disturbance

A: Characteristic or more critical stream types

B: Species that slightly demands more on water quality than the C types

C: Species that can survive under many different environmental conditions (eurytopic species)

In September 2012 and April 2013 the present macroinvertebrates per wooden construction were determined again. These monitoring results gave surprising results, because some rare species for the Netherlands were found. For example, there were many catches of the rare *Goera pilosa*. There were also larvae of the *Gomphus vulgatissimus* (figure 5) found and *Aphelocheirus aestivalis* (figure 6) at several places.

These are all rare species characteristic for a healthy lowland river stream which represents an improved water quality in the Netherlands.

It is surprising that these species have been observed this soon after the application of the wooden constructions. It is notable that in case of wood construction 2, 4, 5 and 6, the number of macroinvertebrates taxa have increased in such a way, that for at least one of the two measuring times, the highest level is scored. A possible explanation for construction 9 can probably be found in the appearance of local gravel beds. Shadowing can also be influenced by the higher number of macroinvertebrates taxa. For final conclusions, it is too early at this moment.

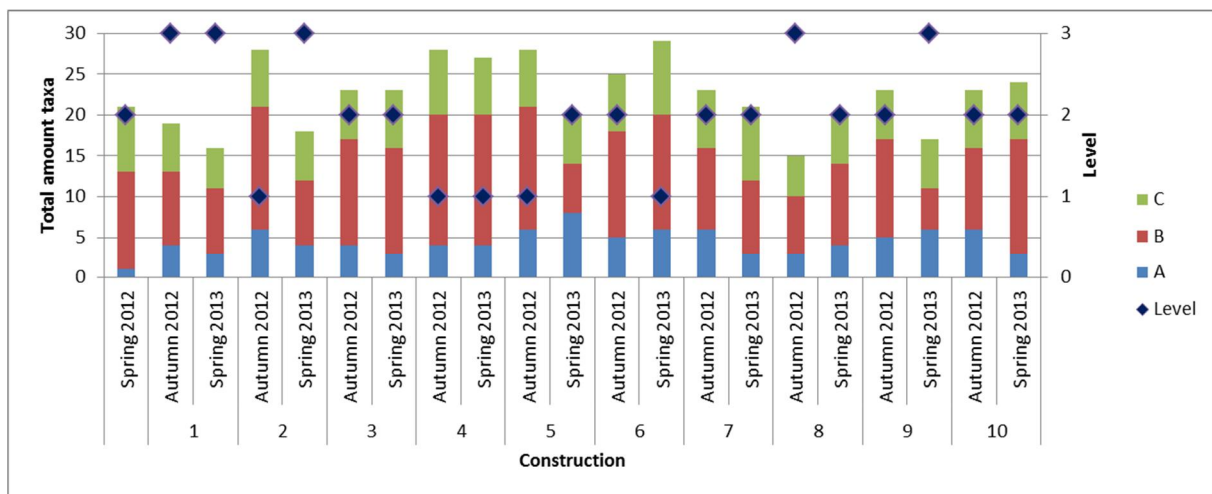

Figure 4: Relationship classes A, B and C total number of taxa autumn 2012 and spring 2013 in comparison to the spring 2012

Closing remarks

The first results indicate an increase in flow rate and more variation in water velocity and water depth. Furthermore, the wooden structures have a positive impact on hydromorphological processes, substrate variation (figure 4) and at the presence of macroinvertebrates. However, there are some differences between the individual wooden structures for the examined parameters. Each wooden structure has a different effect on substrate diversity, target species abundances, water velocity heterogeneity and water level changes. During the following sampling periods in 2014 and 2015 the same and even more species specific for healthy stream ecosystems were found. The monitored and described positive results have already led to the use of dead wood in other streams within the catchment area of the water board Aa and Maas.



Figure 5: *Gomphus vulgatissimus*
(photo: AQUON)



Figure 6: *Aphelocheirus aestivalis*
(photo: AQUON)

Dams removal in the Selune River (France): a long-term scientific and interdisciplinary program

Fraisse S, Roussel J & Bagliniere J

STEPHANE FRAISSE,
JEAN-MARC ROUSSEL & JEAN-LUC BAGLINIERE

INRA UMR 0985 Ecologie et Santé des Ecosystèmes
Equipe Conservation et Restauration des Ecosystèmes Aquatiques
65 rue de St Brieuc, 35 042 Rennes Cedex, France.

stephane.fraisse@rennes.inra.fr

Introduction

Dams are among the most widespread alterations on aquatic ecosystems, 60% of the world's major rivers being impounded for human use (Nilsson et al. 2005). Acting as barriers, dams disconnect upstream and downstream reaches and affect physical, chemical and biological fluxes and processes. They modify flow regime by delaying peak flow and decreasing their magnitude downstream. Immediate sections above the dam are turned into reservoirs that could extend over several kilometers upstream. The reservoirs act as sediment traps, resulting in a downstream release of water partially free of solid particles with a modified potential to erosion (Kondolf 1997). It modifies geomorphic processes and conducts to channel incision and/or lateral erosion depending on the geological nature of the substratum (Kondolf 1997). These changes decrease the lateral connectivity with riparian ecosystems leading to changes in riparian vegetation community, inorganic and organic matters fluxes (Quiñones et al. 2014). River nutrients load and cycling are modified, and combined with new geomorphic conditions, this affects aquatic communities such as macrophytes, macroinvertebrates, fish and especially migrating species. For species that use bottom substratum in running waters to spawn (for instance, salmonids and lampreys), the availability of suitable habitats can strongly be reduced. For migratory fish such as diadromous species, dams are difficult or impossible to pass, and migration in the reservoir can lead to fish disorientation and predation increase (Pelicice et al. 2014).

Besides these perturbations, dams have begun to induce economic losses and to show safety issues. Indeed, the number of old dams increases rapidly since most of them were built between 1950 and 1979 (44 615 constructions) (Wallace 2014). A lot of dam removal operations have been scheduled in the USA notably, and half the dam removal operations ever recorded (i.e. more than 500 removals) have been done since 2000 only (Service 2011). However, few have been monitored by scientific studies while they resulted in large ecological, geological and even socioeconomic changes. In addition, most of these studies involve small dams, i.e. less than 8 m high (Pohl 2002). Owing current changes in the legal context related to ecological issues, dam removal operations would be even more common, highlighting the necessity of studies to assess the positive and negative impacts of such restoration programs.

In Europe, dam removal operations are growing up too but scientific monitoring remains scarce. In France, the removal of two big dams (16 m and 36 m high) on the Sélune

River has been planned for 2020. A 16-years multidisciplinary scientific program has been planned to evaluate dam removal as a restoration tool for aquatic ecosystem. It involves 20 labs of complementary research fields that aim at studying physical, chemical and ecological mechanisms underlying restoration of running waters and river valley after dam removals.

Context of dams removal operation

The Sélune River is a 91 km river long, flowing from a rural landscape in the Natural Park of Normandy-Maine to the Mont Saint-Michel Bay (UNESCO's world heritage site), France (Fig. 1). The river drains a watershed of 1 083 km² counting 57 000 inhabitants while the human activities are mostly linked to agriculture.

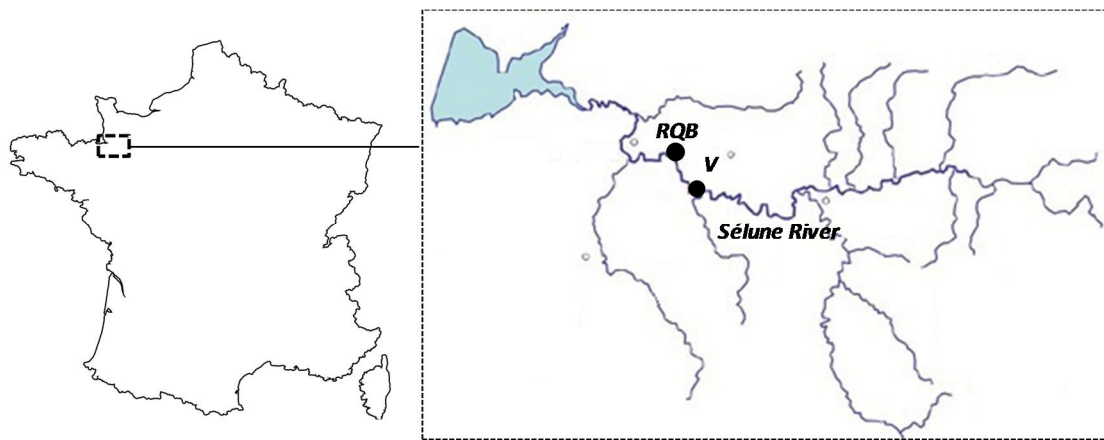

Fig. 1 Geographical location of the Sélune River and position of the two dams: la Roche-qui-Boit (RQB) (16 m) and Vézin (V) (36 m).

Sélune River is one of the four salmon rivers flowing into the Mont Saint-Michel Bay. Seven diadromous species inhabit this area: Atlantic salmon, sea trout, European Eel, river and sea lamprey, Allis and Twaite shad. However, Sélune River is regulated by two hydroelectric dams, La-Roche-qui-Boit and Vézin dams (16 and 36 m respectively), reducing the distribution area of diadromous species to the 12 km downstream part of the River (Salanié et al. 2001). In the current legal context (European Water Framework Directive), and because the production of electricity would not be sufficient even following expensive renewals, the French government decided to demolish the two dams by 2019. Alongside, a major project of re-orientation of the whole watershed, including restoration of running waters, has been set up to develop a sustainable economy in the valley. These operations constitute an excellent opportunity to study how dam removal modifies ecosystem and how it can be used as a tool in restoration programs.

Description of the scientific program

The scientific program includes multiple research areas organized in four interconnected tasks. Ongoing projects are characterizing the initial conditions prior to dams' destruction (6 years) in order to get a reference state that will be compared to the post removal conditions monitored for the following 10 years.

The first task relies on social geography and aims to study the appropriation process of dam removal by inhabitants of the valley. Indeed, besides electrical power production,

recreational uses linked to water impoundment (sailing activities and fishing) have developed. Hence the announcement of dams' removal operation led to strong local opposition. Through surveys conducted on watershed inhabitants (from up to downstream), the first task intends to understand the pro and cons toward such operation, and their potential evolution through time. Representations of the river by the inhabitants and their evolution will be evaluated to assess how these representations contribute to the acceptance of restoration program. Regular surveys will also assess the involvement of inhabitants in the creation of this new territory in the valley. The assessment of the watershed restoration program sustainability in a socio economic point of view will be one of the major goals of this task.

The second task includes studies operating at the watershed scale by implementing a landscape ecology approach. Studies prior to dam removal will focus on the colonization potential of the newly emerged riparian zones by plants through the characterization of the seed bank, which will be compared to the future vegetation. At the same time, modification of physiological state of riparian tree in response to dam removal will be monitored. The studies also aim to identify the effects of landscape structure on riparian zones, and how they will respond to both dams' removals and modifications in agricultural practices related to the watershed restoration program.

The third task focuses on physical river dynamics. Dams' removal is expected to strongly impact both flow and temperature regime, sediment fluxes and water chemistry (nutrient load and some heavy metals). All these parameters are currently monitored to provide a reference state. Analyses will be continued after dams' removal to assess changes in these fluxes. Channel morphology dynamic is also expected to be strongly modified. These expectations will be assessed through cutting edge technologies (full wavelength Lidar) to show the modification in lateral erosion and channel incision. Besides, groundwater quality, quantitative exchanges between aquifer and the river and their modification in response to dams' removal will be evaluated. Finally, the suitability of neo-habitats for aquatic fauna will be estimated.

The fourth task relates on modifications of aquatic biota in response to dam removal. The dynamic of colonization of the new available habitats by diadromous fish species constitutes one of the major goals of this task. At the same time, studies focusing on the emergence of successful evolutionary strategies will be conducted through the characterization of individual life history traits. Macroinvertebrates and macrophytes will be monitored since modifications of bottom substratum are expected to strongly affect these communities. They will also be used to assess water quality and ecosystem health recovery. Invasive species (crayfish and aquatic plants) will be monitored to study possible adverse dispersal facilitation and interactions with native organisms after dams' removal. Investigations on zooplankton, phytoplankton and periphyton will be carried out to decode structural and functional modifications in their communities and for productivity. Finally, energy transfers and interactions among aquatic food web will be assessed to understand the fundamental changes that occur in the functioning of aquatic ecosystems.

Conclusion

Dams are widespread over the world but safety, economic and/or ecological issues will probably lead to increasing removal operations in the future. Nonetheless, dam removal has to be viewed as ecological disturbance since it results in a deep change at the entire ecosystem scale and for functional processes occurring over long-term period (Stanley and Doyle 2003). In this context, the scientific program on the Sélune River is a significant challenge. For the first time, dams' removal operations will be studied alongside a long-term scientific monitoring that will cover a range of complementary research areas including functional ecology, landscape ecology, social geography and geology. This program includes a reliable pre-removal diagnostic (6 years) to provide essential information for assessing the success of this restoration program. The scientific survey will be carried out for 10 years after dams' removal, providing a unique study-case of river restoration after dams' removal.

References

- Kondolf, G.M. (1997) Hungry water: effects of dams and gravel mining on river channels. *Environmental Management* 21, 533–551.
- Nilsson, C., Reidy, C. A., Dynesius, M. and Revenga, C. (2005) Fragmentation and Flow Regulation of the World's Large River Systems. *Science* 308, 405–408.
- Pelicice, F.M., Pompeu, P.S. and Agostinho, A.A. (2014) Large reservoirs as ecological barriers to downstream movements of Neotropical migratory fish. *Fish and Fisheries*, 1–19.
- Pohl, M.M. (2002) Bringing down our dams: Trends in American dam removal rationales. *Journal of the American Water Resources Association* 38, 1511–1519.
- Quiñones, R.M., Grantham, T.E., Harvey, B.N., Kiernan, J.D., Klasson, M., Wintzer, A.P. and Moyle, P.B. (2014) Dam removal and anadromous salmonid (*Oncorhynchus* spp.) conservation in California. *Reviews in Fish Biology and Fisheries* 25, 195–215.
- Salanié, J., Le Goffe, P. and Surry, Y. (2001) Évaluation des bénéfices procurés par le démantèlement de barrages hydroélectriques: le cas de la pêche au saumon sur la Sélune. *Ingénieries* 39, 65–78.
- Service, R.F. (2011) Will Busting Dams Boost Salmon? *Science* 334, 888–892.
- Stanley, E.H. and Doyle, M.W. (2003) Trading off: the ecological effects of dam removal. *Frontiers in Ecology and the Environment* 1, 15–22.
- Wallace, L.B.A. (2014) Condit dam removal: a decision-making comparison with removal of Elwha River dams. Kansas State University.

The response of hydrophyte growth forms and plant strategies to river restoration

Ecke F *et al.*

FRAUKE ECKE¹, SEPPO HELLSTEN², JAN KÖHLER³, ARMIN LORENZ⁴, JAANA RÄÄPYSJÄRVI², SABINE SCHEUNIG³, JOEL SEGERSTEN¹ & ANNETTE BAATTRUP-PEDERSEN⁵

¹*Department of Aquatic Sciences and Assessment, Swedish University of Agricultural Sciences (SLU), P.O. Box 7050 750 07 Uppsala, Sweden.*

²*Finnish Environment Institute SYKE, Freshwater Centre, P.O. Box 413. 90014 University of Oulu, Finland.*

³*Leibniz-Institute of Freshwater Ecology and Inland Fisheries (IGB), Müggelseedamm 301, 12587 Berlin, Germany.*

⁴*Department of Aquatic Ecology, University of Duisburg-Essen, Universitätsstr. 5 45141 Essen, Germany.*

⁵*Department of Bioscience, Aarhus University, Vejlsovej 25, P.O. Box 314 8600 Silkeborg, Denmark.*

Evaluating ecological responses to restoration is important for assessing the success of river restorations. We evaluated the response (effect size) of species richness and diversity of aquatic macrophyte (hydrophyte, in-stream aquatic plant) growth forms and strategies (Grime's CSR strategies; C competitive, S stress tolerant, R ruderal) in 10 small- and 10 large-scale river restoration projects in nine European countries. Species richness and diversity of elodeids (submerged without floating leaves) increased, whereas the proportion of C strategies decreased at small scale-scale restoration sites with mainly widening as the main restoration measure. Flow restoration positively affected effect size of nymphaeids (floating-leaved). Catchment properties explained the effect size of the proportion of C strategies in the plant communities. Our results highlight the importance of river and catchment properties when evaluating river restoration projects. We suggest hydrophyte growth forms and plant strategies as suitable response variables to assess the success of river restoration projects.

Introduction

The degradation of rivers and streams is an increasing problem worldwide, jeopardizing their ecological quality and provisional services (Gleick 2003). Hydrophytes (aquatic vegetation) are important for the structure and functioning of running waters and their loss may have cascading effects on important functional properties of stream ecosystems.

River restoration is expected to increase habitat heterogeneity, i.e. structural complexity, and therefore to favour species richness and diversity *sensu* the 'habitat heterogeneity hypothesis' (e.g. Simpson 1949; MacArthur & Wilson 1967), even though results so far are rather ambiguous.

Here, we evaluate the restoration response of hydrophytes in a space-for-time and impact-control approach, focusing on hydrophyte growth forms (bryophytes, lemniids, nymphaeids, lemniids) and plant strategies, *viz.* competitive (C), stress (S) and ruderal/disturbance (R) strategies (Grime 1974) in the communities.

Methods

Our study comprised 10 small-scale and 10 large-scale river restoration projects distributed in nine European countries. Hydrophytes were surveyed during the peak of the growing season (July to mid-September) applying an EU Water Framework Directive (WFD) compliant sampling protocol (Schaumburg *et al.* 2004). One reach of 200 m length was sampled in each of the restored and degraded sections by wading in a zigzag manner across the channel and walking along the riverbank. In non-wadable areas, the river bottom was examined with a rake (on a long pole or at the end of a rope) to reach the hydrophytes. The abundance of each species was recorded according to a 5-point scale: 1= 1-5 %; 2= 5-25 %; 3= 25-50 %; 4= 50-75 %; 5= 75-100 %.

As measures of species diversity, we calculated species richness and Shannon diversity. For each site, we calculated the mean proportion of CSR strategies in the plant community based on the presence data of all vascular species. Effect size of species richness and diversity of growth forms and of the proportion of macrophyte plant strategies (Grime's CSR strategies) in the plant communities was used as response variable. We calculated effect sizes as the difference between the restored and corresponding degraded upstream site.

We evaluated effect size in relation to the size of the restoration (small or large), main type of restoration measure (widening, remeandering, instream measures, or flow restoration), and catchment properties.

Results

In total, we found 143 species of which 70 hydrophyte species with a median of seven hydrophyte species per site, ranging from zero (degraded site in Austria and both degraded sites in the Czech Republic) to a maximum of 16 species (small-scale restoration site in Sweden). Bryophytes were the most species-rich growth form (31 species; excluding the bryophyte *Riccia fluitans* L.), followed by elodeids (24 species), nymphaeids (eight species), lemnids (six species; including the bryophyte *Riccia fluitans* L.) and isoetids (one species).

The effect size of species richness but not of diversity among growth forms differed at small-scale restored sites (species richness; ANOVA $\chi^2_{(n=10, df=3)} = 9.94, P < 0.05$) and also when combining all restored sites (species richness, ANOVA $\chi^2_{(n=20, df=3)} = 15.23, P < 0.01$), but not in large-scale restored sites (species richness, ANOVA $\chi^2_{(n=10, df=3)} = 6.11, P > 0.05$) (Fig. 1). The effect sizes were positive for richness of elodeids (increase by four species) and lemnids (increase by one species) in small-scale restored sites and also when combining all restored sites, whereas bryophyte richness showed a negative response (minus one species) at small-scale restored sites (Fig. 1).

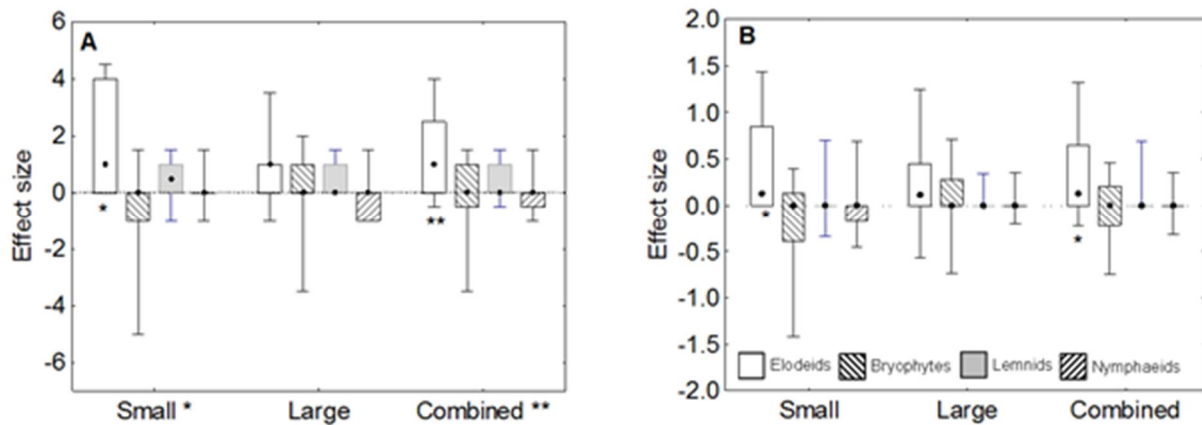

Figure 1. Median effect size of the species richness (A) and diversity (B) of hydrophyte growth forms at small-scale ($n = 10$) and large-scale ($n = 10$) restoration sites, as well as at all restoration sites combined ($n = 20$). Boxes represent 25 and 75 percentiles and whiskers 10 and 90 percentiles, respectively. Asterisks to the right of the restoration size class indicate significant differences ($P < 0.05$) among growth forms for the respective restoration size class. Asterisks below box-plots indicate that the effect size differed significantly from zero ($* P < 0.05$, $** P < 0.01$).

The type of restoration measure applied affected the effect sizes. At sites with widening as the main restoration measure, effect sizes of richness but not of diversity differed among growth forms. Sites with widening and flow restoration as the main restoration measure displayed positive effect sizes of species richness of elodeids compared to that found in sites subjected to other restoration measures (Kruskal-Wallis test, $H_{(3, n = 18)} = 10.74$, $P > 0.05$).

The studied sites were generally dominated by communities characterized by species with high proportion of competitive (C) (mean $51.5 \pm \text{SD } 18.0$ %) and ruderal (R) strategies (mean $30.6 \pm \text{SD } 10.8$ %) and only to a lesser degree by stress tolerant (S) strategies (mean $17.9 \pm \text{SD } 12.8$ %). A more detailed evaluation revealed differences in the proportion of CSR strategies between restored and degraded sites for small-scale and all restorations combined (Fig. 2a). At small scale restoration sites and at all restoration sites combined, effect size of the proportion of strategies varied among strategy types (ANOVA $\chi^2_{(n = 10, df = 2)} = 7.40$, $P < 0.05$ and ANOVA $\chi^2_{(n = 20, df = 2)} = 6.30$, $P < 0.05$, respectively). The proportion of S strategies in the plant communities showed a positive effect size in small-, but a negative one at large-scale restoration sites (Kruskal-Wallis test, $H_{(1, n = 20)} = 6.61$, $P < 0.05$) (Fig. 2a). Widening resulted in differences in the proportion of strategies in the plant communities (ANOVA $\chi^2_{(n = 9, df = 2)} = 14.00$, $P < 0.001$) (Fig. 2b). The effect size of the proportion of the C strategy differed among restoration types (Kruskal-Wallis test, $H_{(3, n = 18)} = 12.36$, $P < 0.01$). Especially the negative effect of widening on the proportion of the C strategy was pronounced (Fig. 2b).

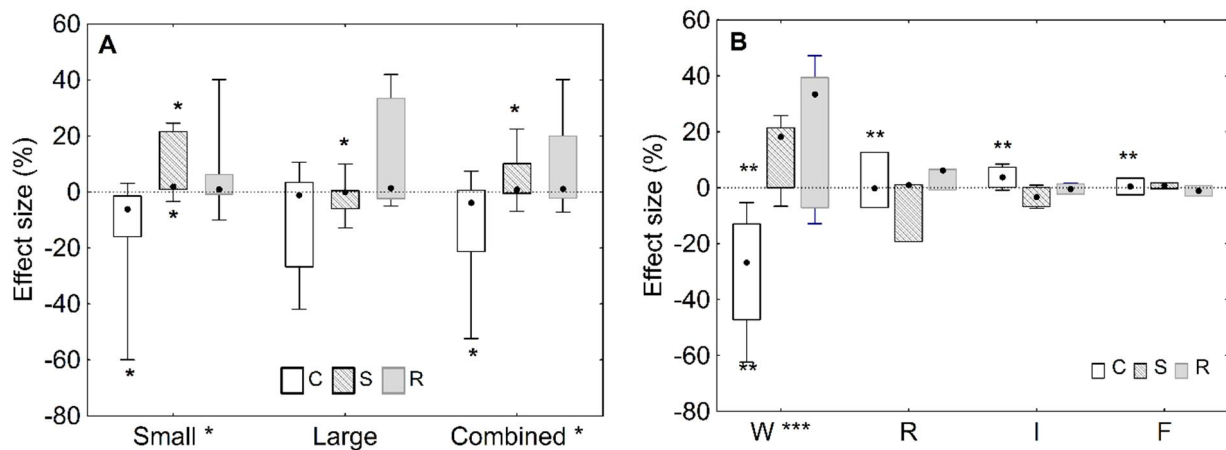

Figure 2. Median effect size of CSR plant strategies at small-scale ($n = 10$), large-scale ($n = 10$) restoration sites, and at all restoration sites combined ($n = 20$) (A) and at sites of different restoration measures (W, widening $n = 9$; R, remeandering $n = 3$; I, instream measures $n = 4$; F, flow restoration $n = 2$) (B). Boxes represent 25 and 75 percentiles and whiskers 10 and 90 percentiles, respectively. Asterisks to the right of the classes indicate significant differences among strategies of the respective classes. Asterisks below box-plots indicate that the effect size differed significantly from zero. Asterisks above box-plots indicate that the effect size for a strategy differed between classes; * $P < 0.05$, ** $P < 0.01$ and *** $P < 0.001$.

Discussion

Restoration measures are conducted to reverse this process even though restoration measures per se may not guarantee restoration success (Palmer, Menninger & Bernhardt 2010). Our study revealed a complicated relationship between restoration measures and the response of hydrophyte growth forms and plant strategies. Surprisingly, responses of both growth forms and CSR plant strategies were more pronounced at small-scale compared to large-scale restoration sites. If we presume that the here studied restoration measures represent 'ultimate goal' measures, the scale of restoration per se, and probably the amount of invested resources, are therefore not a good indicator of restoration success.

The studied restoration measures appeared to influence the response of the macrophyte communities. Elodeids including species such as *Ceratophyllum demersum* L., *Hippuris vulgaris* L. and *Potamogeton gramineus* L. were next to bryophytes the most species-rich growth form. Elodeids responded positively to widening and flow restoration measures. We need to consider though, that flow restoration was performed in two systems, only. Riverbed widening was the restoration measure with the most pronounced responses on all growth forms and proportion of CSR strategies. In contradiction to the habitat heterogeneity hypothesis (Simpson 1949; MacArthur & Wilson 1967) but in line with the conclusions by Palmer et al. (2010), riverbed widening only increased species richness of elodeids, but not their diversity, and not the species richness or diversity of the other growth forms.

The mechanisms driving the plant strategy responses at sites with widening as the main measure are unknown. We can suspect that widening creates more variable and

unpredictable habitats that can be characterized by, for example, temporary flooding, and increased grazing by waterfowl. Such variable conditions are probably less favorable for species with a purely competitive strategy. The significant negative response of the proportion of the competitive plant strategy is therefore not surprising.

The effect of local and reach restoration measures might be overruled by upstream and non-restoration-related river characteristics (Lorenz & Feld 2013), which was also supported by our study (results not shown). The species pool at the catchment scale is an important predictor of local plant species richness (Dynesius *et al.* 2004). If species richness is impoverished at the catchment scale, an increase in species richness associated with local restoration measures may be delayed and even fail as also predicted by the concepts of the ghost of land use past (*sensu* Harding *et al.* 1998) and/or an extinction debt (*sensu* Tilman *et al.* 1994).

The need for proper methods to assess the ecological and socio-economic success of restoration projects has become a major task (Bernhardt *et al.* 2005). However, the ability to assess this success is restricted by the lack of proper monitoring programs and assessment methods for different organism groups. Also in our study, we did not monitor species responses along a temporal gradient ranging from prior to after the performance of restoration measures. Instead, we used a space-for-time approach (comparing restored sites with degraded up-stream sites). Future restoration projects should try assessing the true restoration success by monitoring restoration sites. Hydrophyte growth forms and plant strategies proved significant differences between restored and degraded river sections. This study therefore laid a foundation for indicator development to assess the ecological success of river restoration projects.

References

- Bernhardt, E.S., Palmer, M.A., Allan, J.D., Alexander, G., Barnas, K., Brooks, S., Carr, J., Clayton, S., Dahm, C., Follstad-Shah, J., Galat, D., Gloss, S., Goodwin, P., Hart, D., Hassett, B., Jenkinson, R., Katz, S., Kondolf, G.M., Lake, P.S., Lave, R., Meyer, J.L., O'Donnell, T.K., Pagano, L., Powell, B. & Sudduth, E. (2005) Synthesizing U.S. River Restoration Efforts. *Science*, 308, 636-637.
- Dynesius, M., Jansson, R., Johansson, M.E. & Nilsson, C. (2004) Intercontinental similarities in riparian-plant diversity and sensitivity to river regulation. *Ecological Applications*, 14, 173-191.
- Gleick, P.H. (2003) *Global Freshwater Resources: Soft-Path Solutions for the 21st Century*. *Science*, 302, 1524-1528.
- Grime, J.P. (1974) Vegetation classification by reference to strategies. *Nature*, 250, 26-31.
- Harding, J.S., Benfield, E.F., Bolstad, P.V., Helfman, G.S. & Jones, E.B.D. (1998) Stream biodiversity: The ghost of land use past. *Proceedings of the National Academy of Sciences of the United States of America*, 95, 14843-14847.
- MacArthur, R.H. & Wilson, E.O. (1967) *The theory of island biogeography*. Princeton University Press, Princeton.
- Palmer, M.A., Menninger, H.L. & Bernhardt, E. (2010) River restoration, habitat heterogeneity and biodiversity: a failure of theory or practice? *Freshwater Biology*, 55, 205-222.
- Schaumburg, J., Schranz, C., Förster, J., Gutowski, A., Hofmann, G., Meilinger, P., Schneider, S. & Schmedtje, U. (2004) Ecological classification of macrophytes and phytobenthos for rivers in Germany according to the Water Framework Directive. *Limnologica*, 34, 283-301.
- Simpson, E.H. (1949) Measurement of diversity. *Nature*, 163, 688.
- Tilman, D., May, R.M., Lehman, C.L. & Nowak, M.A. (1994) Habitat destruction and the extinction debt. *Nature*, 371, 65-66.

The effect of river restoration on fish, macroinvertebrates and aquatic macrophytes: a meta-analysis

Kail J et al.

JOCHEM KAIL¹, KAREL BRABEC², KATHRIN JANUSCHKE¹, MICHAELA POPPE³

¹*Department of Aquatic Ecology, University of Duisburg-Essen, Universitätsstr. 5 Essen, 45141, Germany*

²*Research Centre for Toxic Compounds in the Environment, Faculty of Science, Masaryk University, Kamenice 753/5, 625 00 Brno, Czech Republic*

³*Institute of Hydrobiology and Aquatic Ecosystem Management, University of Natural Resources and Life Sciences Vienna, Max-Emanuel-Straße 17, 1180 Vienna, Austria*

An increasing number of rivers have been restored over the past decades and several studies investigated the effect on biota. The published monitoring results have already been summarized in narrative reviews but there are few quantitative reviews and a comprehensive meta-analysis on different organism groups and factors influencing restoration effect is missing. We compiled monitoring results and information on catchment, river and project characteristics from peer-reviewed literature and unpublished databases to (i) quantify the effect of restoration measures on fish, macroinvertebrates and macrophytes, and (ii) identify predictors which influence restoration effect. Results indicated positive effects of restoration on all three organism groups, especially of widening projects on macrophyte richness/diversity, instream measures on fish and macroinvertebrates, and higher effects on abundance/biomass compared to richness/diversity. Restoration effect was most strongly affected by agricultural land use, river width and project age. Effects were smaller but generally still positive in agricultural catchments. Since land use is a proxy for different pressures, the underlying causal relationships have to be investigated in more detail. Project age was the most important factor but had non-linear and even negative effects on restoration outcome, indicating that restoration effects may vanish over time. The meta-analysis indicated that river managers in general can expect positive effects of restoration on all three organism groups investigated, especially of widening on macrophytes and instream measures on fish and macroinvertebrates. However, variability was high, stressing the need for adaptive management approaches. Furthermore, the large but non-linear and different (even negative) effects of project age stressed the need for long-time monitoring to better understand the trajectories of change caused by restoration measures and to identify sustainable measures. The meta-analysis was restricted to metrics commonly reported in literature and future studies would greatly benefit from authorities and scientists reporting original monitoring data, which would allow to use functional metrics to investigate the effect of restoration measures and to infer causal relationships.

Introduction

In this meta-analysis, the effect of restoration on biota was quantified based on results reported in peer-reviewed literature and monitoring data from unpublished databases.

The first main objective was to assess the effect that can be expected from different restoration measures on different organism groups. We tested if restoration had an overall positive effect on fish, macroinvertebrates, and macrophytes, and if the effect differed among organism groups, biological metrics (e.g. abundance, richness) and restoration measures. The second main objective was to identify conditions which influence restoration effects, i.e. identify catchment, river and project characteristics which either constrain or enhance the effect of restoration on biota and to assess their relative importance.

Methods

Studies were compiled from peer-reviewed literature and three unpublished databases. In peer-reviewed literature, studies were identified using the search engines Web of Science and SCOPUS. Original monitoring data were compiled from three databases covering 64 projects in Germany, Austria and the Czech Republic. The biological data were complemented by information on catchment, river and project characteristics which potentially either constrain or enhance the effect of river restoration.

The response ratio Δr developed by Osenberg et al. (1997) was used as a standardized effect size of restoration effects following Miller et al. (2010) and Whiteway et al. (2010) (eqn 1)

$$\Delta r = \ln\left(\frac{\bar{X}_T}{\bar{X}_C}\right) \qquad \Delta r = \ln\left(\frac{\bar{X}_T}{\bar{X}_C}\right) \text{eqn 1}$$

with X_T and X_C being the means of the treatment (restored reach) and control (restored reach prior to restoration or nearby unrestored reach in Before/After - BA - and Control/Impact - CI - monitoring designs, respectively). The response ratio is dimensionless with values > 0 denoting a positive effect and negative values a negative effect. For projects with a full BACI monitoring design, two response ratios were calculated, one for the BA and CI component, respectively and response ratios were corrected using the information prior to restoration for the CI and on the control reach for the BA response ratios.

The analysis was restricted to three organism groups (fish, macroinvertebrate, macrophytes), four biological metrics (abundance, biomass, richness, diversity) and the CI monitoring design, for which the number of response ratios was high enough to apply standard statistical tests. The effect of restoration on the number of individuals and the number of taxa was investigated separately since they describe different aspects of biological assemblages. The biological metrics were grouped and named accordingly (abundance/biomass and richness/diversity, referred to as metric groups in the following) resulting in six sub-datasets (three organism groups x two metric groups). Response ratios which were extracted from the same project, organism group and metric group were combined by calculating mean values to avoid pseudo-replication (e.g. Δr for fish individuals per 100 m and biomass of fish per 100 m of the same restoration project), resulting in a total number of 353 unique response ratios which originated from $n = 120$ restoration projects and included $n = 39$ response ratios from full BACI designs.

Main results and discussion

Quantifying restoration effect:

- Considering all three organism groups (fish, macroinvertebrates, macrophytes), the overall effect of restoration on biota was positive, mean response ratios of all six sub-datasets were positive and significantly different from zero. However, response ratios varied greatly and about one third of the projects had no positive or even a negative effect ($\Delta r \leq 0$).
- The high variability of the response ratios might be the reason for the contrasting results reported in literature. Depending on which organism group, biological metric or main restoration measure is investigated, results may greatly differ (e.g. Lepori et al., 2005; Palmer et al., 2010; Pretty et al., 2003 vs. Lorenz et al., 2012; Miller et al., 2010; Schmutz et al., 2014, and review in Roni et al., 2008).
- The higher effect of restoration on macrophytes compared to fish and macroinvertebrates is consistent with the results of replicated studies reporting a positive effect on macrophyte richness and diversity (Lorenz et al., 2012), a low effect on macroinvertebrate richness and diversity (Jähnig et al., 2010; Palmer et al., 2010), and the general finding that restoration effect on richness and diversity is highest for terrestrial and semi-aquatic groups like floodplain vegetation and ground beetles, intermediate for macrophytes, lower for fish, and lowest for macroinvertebrates (Haase et al., 2013; Jähnig et al., 2009; Januschke et al., 2009).
- Restoration had a higher effect on fish and invertebrate abundance/biomass and a lower effect on richness/diversity, indicating that, in general, it is easier to increase the number of individuals in the restored reach than establishing new taxa. This is consistent with the higher mean effect on macroinvertebrate abundance compared to richness reported in Miller et al. (2010).

Importance of catchment, river, and project characteristics:

- It was surprising that agricultural land use limited the effect of restoration on fish but not for macroinvertebrates since it has been identified as a proxy for important pressures limiting the ecological state in several studies. Possibly, the percentage coverage of agricultural land use might have been above a critical threshold, already limiting biota with any further increase having only a minor impact. However, restoration had an overall positive effect even in catchments dominated by agricultural land use (>50%), and hence, results do not question river restoration in agricultural catchments in general.
- River types influenced restoration effects, which were generally higher in gravel-bed rivers and median response ratios approached zero or were even negative in sand-bed rivers for fish and invertebrate richness/diversity and abundance/biomass.
- Results of our meta-analysis and other replicated studies indicated that terrestrial and semi-aquatic organism groups like floodplain vegetation and ground beetles as well as macrophytes benefit most from planform measures and aquatic groups like fish and invertebrates from instream measures (Haase et al., 2013; Jähnig et al., 2009; Januschke et al., 2009; Lorenz et al., 2012; Miller et al., 2010).
- The missing effect of the restored reaches length on restoration outcome cannot be taken as a proof that it is sufficient to restore short river reaches. In all six sub-datasets, virtually all restored reaches were rather short (10-90th percentile range 0.2-2.6 km) and length might have simply been below a critical threshold to increase restoration effects. This is supported by the findings of Schmutz et al. (2014) who

reported that the effect on the number of rheophilic fish species did depend on restored reach length and was largest for reaches > 3.85 km in length.

- Project age was the most important predictor affecting restoration effects, especially for macrophyte abundance which was higher in younger projects. One explanation might be that restoration effect on macrophyte abundance was higher in the first years after restoration and decreased in the following years. Widening and remeandering - the most effective measures for macrophytes - usually comprise extensive restoration works that create pioneer habitats like sparsely shaded, slow flowing shallow areas which can be colonized rapidly from existing seed banks in the restored reaches or by drift of propagules. However, if natural morphodynamic processes are not restored, these habitats are not rejuvenated by disturbances and might have changed to less favourable conditions when channel-features were maturing (e.g. development of riparian vegetation and shading). As a consequence, macrophyte abundance might have decreased and the effect of restoration vanished over time.
- Similarly, results reported in literature show no clear trend of a higher effect of restoration in older projects. Project age had no effect on macrophyte richness and abundance (Lorenz et al., 2012), a small positive effect on the ecological state of fish (Haase et al., 2013), a negative effect on richness of rare fish species but a positive effect on their abundance (Schmutz et al., 2014), and non-linear effects on salmonid abundance (Whiteway et al., 2010) and the abundance of small rheophilic fish species (Schmutz et al., 2015). This stresses the need to use methods capable to detect non-linear relationships and the general need for long-time monitoring to investigate restoration effects over time, to better understand the trajectories of change caused by restoration measures, and to identify sustainable measures which enhance biota in the long-term.

Conclusions and recommendations

In summary, our meta-analysis indicated that river managers in general can expect positive effects of restoration on all three organism groups investigated, especially of widening projects on macrophyte richness/diversity, instream measures on fish and macroinvertebrates, and higher effects on abundance/biomass compared to richness/diversity. This general finding is consistent with studies which found a significant positive effect on single organism groups (Lorenz et al., 2012; Miller et al., 2010; Schmutz et al., 2014; Whiteway et al., 2010). The contrasting results of other studies showing nor or small effects (Jähnig et al., 2010; Lepori et al., 2005; Palmer et al., 2010; Pretty et al., 2003; Stewart et al., 2009) might be due to the high variability found in our meta-analysis, indicating that there are many factors influencing the outcome of restoration projects, and stressing the need for post project appraisals and adaptive management approaches as described in Williams and Brown (2014).

Project age was the most important factor in our study but had different, non-linear, and even negative effects on restoration outcomes for different organism groups, similar to the contrasting results reported in other studies (Haase et al., 2013; Lorenz et al., 2012; Schmutz et al., 2014; Whiteway et al., 2010). This stresses the need for long-time monitoring to investigate the trajectories of change and to identify sustainable restoration measures. Our meta-analysis was restricted to metrics commonly reported in literature and future studies would greatly benefit from authorities and scientists

reporting original monitoring data, which would allow to use functional metrics to investigate the effect of restoration measures and to infer causal relationships. This would offer a great opportunity to make fundamental advances in our understanding of how river restoration affects river hydromorphology and biota and to identify (cost)-effective restoration measures.

References

- Haase, P., Hering, D., Jähnig, S.C., Lorenz, A.W., Sundermann, A. (2013). The impact of hydromorphological restoration on river ecological status: a comparison of fish, benthic invertebrates, and macrophytes. *Hydrobiologia* 704: 475-488.
- Jähnig, S.C., Brabec, K., Buffagni, A., Erba, S., Lorenz, A.W., Ofenböck, T., Verdonschot, P.F.M., Hering, D. (2010). A comparative analysis of restoration measures and their effects on hydromorphology and benthic invertebrates in 26 central and southern European rivers. *Journal of Applied Ecology* 47: 671–80.
- Jähnig, S.C., Brunzel, S., Gacek, S., Lorenz, A.W., Hering, D. (2009). Effects of re-braiding measures on hydromorphology, floodplain vegetation, ground beetles and benthic invertebrates in mountain rivers. *Journal of Applied Ecology* 46: 406–416.
- Januschke, K., Sundermann, A., Antons, C, Haase, P., Lorenz, A.W., Hering, D. (2009). Untersuchung und Auswertung von ausgewählten Renaturierungsbeispielen repräsentativer Fließgewässertypen der Flusseinzugsgebiete Deutschlands. Verbesserung der biologischen Vielfalt in Fließgewässern und ihren Auen. Schriftenreihe des Deutschen Rates für Landespflege 82: 23-39.
- Lepori, F., Palm, D., Brännäs, E., Malmquist, B. (2005). Does restoration of structural heterogeneity in streams enhance fish and macroinvertebrate diversity? *Ecological Applications* 15: 2060–2071.
- Lorenz, A.W., Korte, T., Sundermann, A., Januschke, K., Haase, P. (2012). Macrophytes respond to reach-scale river restorations. *Journal of Applied Ecology* 49: 202–212.
- Miller, S.W., Budy, P., Schmidt, J.C. (2010). Quantifying macroinvertebrate responses to in-stream habitat restoration: applications of meta-analysis to river restoration. *Restoration Ecology* 18: 8–19.
- Osenberg, C.W., Sarnelle, O., Cooper, S.D. (1997). Effect size in ecological experiments: the application of biological models in meta-analysis. *The American Naturalist* 150: 798-812.
- Palmer, M.A., Menninger, H., Bernhardt, E.S. (2010). River restoration, habitat heterogeneity and biodiversity: a failure of theory or practice? *Freshwater Biology* 55: 205–22.
- Pretty, J.L., Harrison, S.S.C., Shepherd, D.J., Smith, C., Hildrew, A.G., Hey, R.D. (2003). River rehabilitation and fish populations: assessing the benefit of instream structures. *Journal of Applied Ecology* 40: 251-265.
- Roni, P., Hanson, K., Beechie, T. (2008). Global review of the physical and biological effectiveness of stream habitat rehabilitation techniques. *North American Journal of Fisheries Management* 28: 856–890.
- Schmutz, S., Kremser, H., Melcher, A., Jungwirth, M., Muhar, S., Waidbacher, H., Zauner, G. (2014). Ecological effects of rehabilitation measures at the Austrian Danube: a meta-analysis of fish assemblages. *Hydrobiologia* 729: 49-60.
- Stewart, G.B., Bayliss, H.R., Showler, D.A., Sutherland, W.J., Pullin, A.S. (2009). Effectiveness of engineered in-stream structure mitigation measures to increase salmonid abundance: a systematic review. *Ecological Applications* 19: 931–941.
- Whiteway, S.L., Biron, P.M., Zimmermann, A., Venter, O., Grant, J.W. (2010). Do in-stream restoration structures enhance salmonid abundance? A meta-analysis. *Canadian Journal of Fisheries and Aquatic Science* 67: 831–841.
- Williams, B.K., Brown, E.D. (2014). Adaptive management: From more talk to real action. *Environmental Assessment* 53: 465-479.

Effects of river restoration on ^{13}C and ^{15}N isotope composition in river and floodplain food webs - an approach on 20 European restoration projects

Kupilas *B et al.*

BENJAMIN KUPILAS¹, NIKOLAI FRIBERG², BRENDAN G. MCKIE³, MAIK A. JOCHMANN⁴,
ARMIN W. LORENZ¹ & DANIEL HERING¹

¹*Department of Aquatic Ecology, University of Duisburg-Essen, Universitätsstr. 5
D-45141 Essen, Germany.*

²*Section of Fresh Ecology, Norwegian Institute for Water Research, Gaustadalléen 21,
NO-0349 Oslo, Norway.*

³*Department of Aquatic Sciences & Assessment, Swedish University of Agricultural
Sciences, P.O. Box 7050, SE-75007 Uppsala, Sweden.*

⁴*Instrumental Analytical Chemistry, University of Duisburg-Essen, Universitätsstr. 5,
D-45141 Essen, Germany.*

Abstract

Restoration of river hydromorphology has potential to affect not only ecosystem structural parameters, including species composition and diversity, but also ecosystem functioning. Despite this, the most-widely used parameters for assessing the success or failure of restoration projects are almost exclusively based on changes in community composition of different biological groups. Consequently, the outcomes of restoration for key ecosystem processes and trophic transfers of energy and nutrients remain poorly understood. We applied stable isotope analysis of ^{15}N and ^{13}C in context of river restoration. We representatively sampled different components of food webs on paired restored and degraded sections of rivers in 20 different catchments throughout Europe. The sampling included elements of the resource base (particulate organic matter, most abundant aquatic and riparian plant material, periphyton), the dominant taxa of benthic invertebrate assemblages belonging to different functional feeding groups, and predatory riparian and non-riparian arthropods. We used these components to quantitatively characterize patterns in trophic structure related to river restoration. Preliminary results indicate e.g. (1) that the dataset is subject to large-scale patterns on European level (latitude, altitude, geology and land use intensity) influencing ^{15}N and ^{13}C enrichment and (2) that benthic invertebrate communities (commonly applied indicators of ecosystem health) were feeding from more diverse carbon sources in restored compared to the degraded river sections.

Introduction

Restoration of river hydromorphology typically enhances habitat diversity in the stream channel and riparian zone as well as aquatic-terrestrial linkages. Therefore, significant alterations of food web structure and trophic relationships can be expected: A higher diversity of feeding- and physical habitat-related niches in the stream can contribute to more complex food webs, particularly if a higher variety of resources is available to increase the number of trophic linkages (Layman et al. 2007a, Woodward 2009). Apart from increases in retention of allochthonous matter (Lepori et al. 2005b), restoration also

might increase the availability of autochthonous sources, e.g. caused by enlarged shallow habitats providing more space for autotrophs (Lorenz et al. 2012). Furthermore, stronger connections between river and floodplain, e.g. caused by a more shallow profile and/or removal of hardened, channelized banks, has potential to increase inundation frequency and hence resource transfers from land to water. At the same time, it will also make aquatic prey more easily accessible to riparian predators. These changes all have implications for complexity of the food web and the relative trophic position of different organisms within the web (Woodward & Hildrew 2002, Woodward 2009).

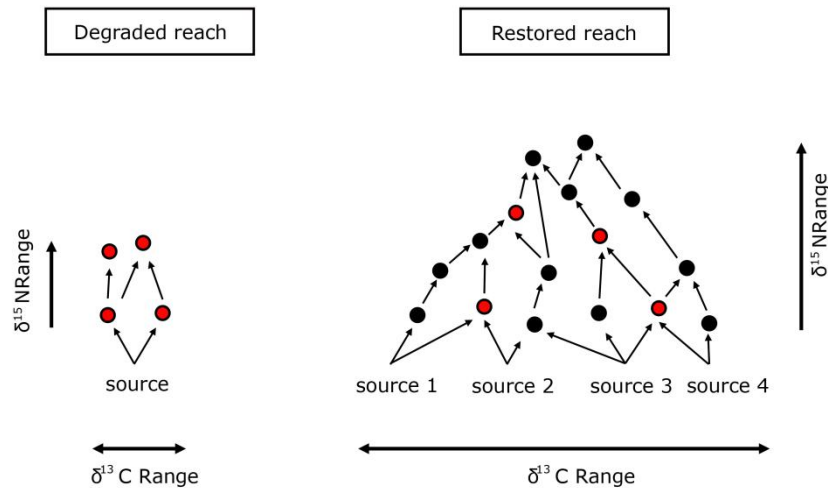

Figure 1. Hypothetical concept of how restoration could affect diversity at the resource base and thereby complexity of the benthic food web (red dots indicate dominant feeding types of benthic invertebrate communities); figure modified after Layman et al. 2007a.

Carbon and nitrogen isotopes provide information on the material assimilated by organisms: $\delta^{15}\text{N}$ is generally used to calculate the trophic position of an organism and $\delta^{13}\text{C}$ and is often used to identify the resource base.

We applied stable isotope analysis of carbon and nitrogen to quantitatively characterize changes in trophic structure following both larger- and smaller scale river restoration projects. We sampled different components of food webs on paired restored and degraded river sections in 20 catchments throughout Europe, allowing comparison of restored sections with degraded "control sites" located upstream.

Here, we start by focusing on benthic invertebrate communities as commonly applied indicators of ecosystem health. We then give an outlook by introducing first results considering the other components sampled. To test for restoration effects on benthic invertebrate communities we used two metrics introduced by Layman et al. (2007b): $\delta^{15}\text{N}$ range (NR) and $\delta^{13}\text{C}$ range (CR) of the dominant feeding types of benthic invertebrate communities to quantify changes in trophic structure between restored and degraded sections.

We expected that our isotopic metrics would show evidence for increased trophic complexity following river restoration, reflecting increases in habitat diversity, resource diversity, and aquatic-terrestrial linkages (Fig. 1). For example, we hypothesized that (i) the CR metric would increase (i.e. an increase in $\delta^{13}\text{C}$ variation), reflecting the availability of a more varied food source following restoration and that (ii) the NR metric would also increase (increasing $\delta^{15}\text{N}$ variation), if increases in the diversity of basal resources allow an increase in food chain length. We further expected these effects would (iii) increase with restoration extent, reflecting stronger changes in habitat complexity and aquatic-terrestrial connectivity.

Methods

In ten regions across Europe we sampled four river sections: one river section of a large restoration project (R1), one section of a small restoration project (R2) and non-restored, degraded sections directly upstream of the restored sections (D1, D2).

Representative samples of the food web components were collected to identify effects of restoration on patterns in trophic structure. Samples contained elements of the resource base (particulate organic matter, most abundant aquatic and riparian plant material, periphyton), dominant benthic invertebrate taxa representing different functional feeding groups to obtain an overview of the isotopic signatures of consumers at different trophic levels, and riparian and non-riparian arthropods (ground beetles and spiders).

Content of carbon and nitrogen and stable isotopes of carbon and nitrogen of each sample were analysed. The isotope data were expressed in the common δ -notation.

For invertebrate assemblages we calculated following metrics as introduced by Layman et al. (2007b): (i) $\delta^{15}\text{N}$ range (NR), calculated as maximum $\delta^{15}\text{N}$ minus minimum $\delta^{15}\text{N}$; and (ii) $\delta^{13}\text{C}$ range (CR), calculated as maximum $\delta^{13}\text{C}$ minus minimum $\delta^{13}\text{C}$. We used NR as an indicator for the trophic length of the communities and CR as an indicator of the range of assimilated carbon sources. To quantify restoration effects concerning the invertebrate communities, we first pairwise compared NR and CR between restored and degraded sections (R vs. D) and between long and short restored sections (R1 vs. D1 and R2 vs. D2). We further used an effect size by calculating the response ratio of Osenberg et al. (1997), where values > 0 are denoting a positive effect (e.g. an increase in $\delta^{13}\text{C}$ range), and values < 0 are indicating a negative effect.

For the calculation of community-wide metrics (NR and CR) we used the package Stable Isotope Analysis in R (SIAR). Further statistical analyses, including Wilcoxon Matched Pair tests, t-tests and Mann Whitney U tests, were run in Statistica 8 (StatSoft).

Results

Here, we give a first impression of the results shown during the presentation: The pairwise comparison of benthic invertebrate communities between restored (R) and degraded (D) sections (large and small projects pooled) showed minor differences in both $\delta^{15}\text{N}$ range and $\delta^{13}\text{C}$ range. The difference between restored and degraded sections was not significant (Wilcoxon Matched Pair test, $p > 0.06$, $n = 16$, Table 1). The median NR was equivalent to the distance between two trophic levels (3.68 ‰ in restored sections and 3.12 ‰ in degraded sections, $n = 16$, Table 1). For the comparison of effect sizes

according to Osenberg et al. (1997), values above zero indicate enhanced $\delta^{15}\text{N}$ range or $\delta^{13}\text{C}$ range in restored sections. Restoration had an overall positive effect on CR as the effect size ratio differed significantly from zero (t-test, $p < 0.05$, Fig. 2a).

Table 5: Pairwise comparison of benthic invertebrates $\delta^{13}\text{C}$ and $\delta^{15}\text{N}$ ranges for R vs. D, R1 vs. D1 and R2 vs. D2 using Wilcoxon Matched Pair test. 25 and 75% percentiles are given in parentheses. Significant differences ($p < 0.05$) are indicated by bold median values.

	$\delta^{15}\text{N}$ range (‰)		$\delta^{13}\text{C}$ range (‰)		n
	Median	p	Median	p	
R1 and R2 pooled					
R	3.68 (2.24 - 4.8)	0.80	6.29 (5.42-8.89)	0.06	16
D	3.12 (2.45-4.27)		5.64 (4.12-8.33)		16
Large projects					
R1	3.68 (2.32-4.17)	0.78	7.46 (5.19-10.29)	0.01	8
D1	2.94 (2.4-4.01)		6.39 (4.12-8.33)		8
Small projects					
R2	3.71 (2.14-5.32)	1.00	5.72 (5.42-6.87)	0.89	8
D2	3.14 (2.54-4.49)		5.20 (4.17-7.98)		8

The pairwise comparison between the four groups of sections (large restored sections: R1; corresponding degraded sections: D1; small restored sections: R2; corresponding degraded sections: D2) showed minor differences for $\delta^{15}\text{N}$ range (Table 1). In contrast, CR differed significantly between R1 and D1 (Wilcoxon Matched Pair test, $p < 0.05$, $n = 8$). The comparison between small restored sections and the corresponding degraded sections (R2 vs. D2) was not different. Similarly, the pairwise calculated effect sizes, expressed as response ratios after Osenberg et al. (1997), revealed a positive effect of restoration on CR on large restored river sections (R1) (t-test, $p < 0.05$, Fig. 2b) but not for the small restored sections (R2) (t-test, $p > 0.33$).

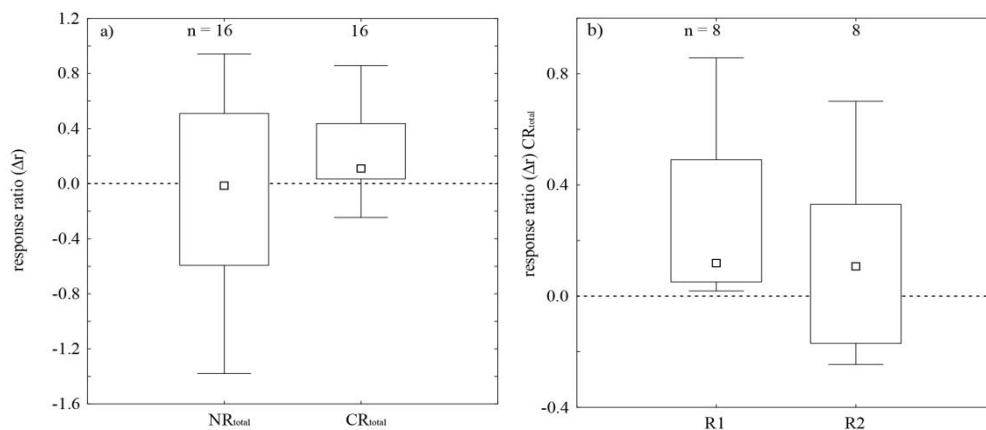

Figure 2. a) General restoration effect (R1 and R2 pooled) calculated as response ratio after Osenberg et al. (1997) for NR and CR and b) comparison of response ratios based on CR in large (R1) and small (R2) restoration projects; effect sizes were pairwise calculated (Median; Box: 25%–75%; Whisker: Min-Max).

Discussion

Restoration of rivers is expected to increase the diversity of habitat- and resource-based niches as well as aquatic-terrestrial connection, which together have potential to favour greater trophic complexity. In line with this, we expected changes in the isotopic signatures of benthic invertebrate consumers indicative both of increased resource breadth (indicated by $\delta^{13}\text{C}$ range), and increases in trophic length (indicated by $\delta^{15}\text{N}$ range) following river restoration. We further expected that the larger the restoration the bigger the impact. We found some support for an increase in resource breadth associated with restoration across all restored sections, with these effects stronger for larger-scale restoration projects. In contrast, there was no support for a general increase in trophic length across all catchments, though increases in NR ratios were apparent between some specific degraded and restored sections, suggesting such effects might depend on local assemblage composition and/or environmental conditions. These findings suggest that restoration in Europe does result in modest increases in trophic complexity. However, this is largely dependent on positive effects on the variety of resources assimilated by consumers (confirming hypothesis 1), rather than trophic length (rejecting hypothesis 2), with both effects further depending on restoration extent.

Outlook

We further show if the metrics (NR and CR) are related to the type of restoration measure employed, e.g. if projects which mainly aim at river widening (usually affecting both instream habitats and connectivity of water and land and thereby enhancing availability of autochthonous and allochthonous carbon resources) affecting food webs more strongly than projects which applied measures mainly affecting the river channel itself (e.g. instream measures or flow restoration).

We further show preliminary results in which we considered the other components of the food web. For example, we tested if restoration increases aquatic prey within the diet of riparian arthropods and thereby indicating an enlarged aquatic-terrestrial interaction (*vice versa*: nutrient and energy flow from water to land).

References

- Layman, C.A., J.P. Quattrochi, C.M. Peyer & J.E. Allgeier, 2007a. Niche width collapse in a resilient top predator following ecosystem fragmentation. *Ecology Letters* 10: 937–944.
- Layman, C.A., D.A. Arrington, C.G. Montana & D.M. Post, 2007b. Can stable isotope ratios provide for community-wide measures of trophic structure? *Ecology* 88: 42–48.
- Lepori, F., D. Palm & B. Malmqvist, 2005b. Effects of stream restoration on ecosystem functioning: detritus retentiveness and decomposition. *Journal of Applied Ecology* 42: 228–238.
- Lorenz, A.W., T. Korte, A. Sundermann, K. Januschke & P. Haase, 2012. Macrophytes respond to reach-scale river restorations. *Journal of Applied Ecology* 49: 202–212.
- Osenberg, C.W., O. Sarnelle & S.D. Cooper, 1997. Effect size in ecological experiments: the application of biological models in meta-analysis. *The American Naturalist* 150: 798–812.
- Woodward, G. & A.G. Hildrew, 2002. Food web structure in riverine landscapes. *Freshwater Biology* 47: 777–798.
- Woodward, G., 2009. Biodiversity, ecosystem functioning and food webs in fresh waters: assembling the jigsaw puzzle. *Freshwater Biology* 54: 2171–2187.

The introduction of large wood to improve biodiversity in a modified navigable river stretch of the Dutch Rhine

Liefveld W M et al.

W.M. LIEFVELD & M. DORENBOSCH

Bureau Waardenburg, P.O. Box 365, 4100 AJ Culemborg, The Netherlands.

M.M. SCHOOR, H. VAN RHEEDE, A.SIEBEN & P.P. DUIJN

Rijkswaterstaat, P.O. Box 25, 6200 MA Maastricht ED, The Netherlands

A. KLINK

Hydrobiologisch Adviesburo Klink, Boterstraat 28, 6701 CW Wageningen, The Netherlands

L.M. DIONISIO PIRES

Deltares P.O. Box 177, 2600 MH Delft, The Netherlands.

Large wood in the form of entire trees has been introduced into the navigable river Rhine as a pilot measure to improve the aquatic biodiversity. Within the same year characteristic riverine macro-invertebrate species appeared. Local fish communities attained a higher level of diversity near the large wood compared to traditional rip-rap banks and native species were dominant instead of alien species that dominate artificial substrates. These results encourage new pilot projects e.g. combining ecological restoration with river training constructions.

Introduction

River ecosystems in the Netherlands lost much of their ecological value due to human impact, such as shipping and flood control measures. In order to improve biodiversity and water quality, these regulated rivers are now to be re-naturalised to a feasible extent. In impounded river stretches, potentially effective measures are scarce. A major missing element is the presence of large wood structures, such as dead trees, which are usually removed to facilitate water flow and navigation. Large wood structures are an important habitat for both fish and macro-invertebrates in free flowing rivers (Piégay & Gurnell 1997, Kail *et al.* 2007, Miller *et al.* 2010, Roni *et al.* 2015), and may contribute to the goals of the Water Framework Directive (WFD). But does it also improve biodiversity in an impounded river stretch, without hampering navigation and flood-control?



Figure 1: Location of the study area along the River Rhine in the Netherlands. Green dots=pilot locations, red line=weirs

Methods

To answer this question Rijkswaterstaat started a pilot study in 2014 by introducing large trees in the Nederrijn-Lek, a branch of the river Rhine (Fig. 1). The pilot study was carried out at four locations (Fig. 1) at sites that differed in water depth, stream dynamics and exposure (main channel vs. side waters). A total of nine trees (length ~15 m), including branches and roots, were placed just under the water surface near the banks of the river in the main channel (Fig. 2), a side channel and a fishway. The trees were attached to steel beams by strong steel chains. Another six trees were placed at different depths in deep erosion pits that occur near the groynes close to the main channel (Fig. 2).



Figure 2: Entire trees were fixed in the riverbed and side channel (left) and concrete slabs were used to submerge the trees in deep erosion pits (right).

The main goal of reintroduction of large wood structures into the river system was to enhance ecological diversity and to see if this measure leads to improvement of the metrics within the WFD, especially for fish and macro-invertebrates. Hence, monitoring was concentrated on these taxa. We applied a combination of various sampling methods to gain insight in the whole fish-community and in the most appropriate method for macro-invertebrates.

The function of large wood structures for fish was evaluated at four sites and at three control sites in the main channel and the side channel. Each site was investigated by a combination of electro fishing and fyke net trapping during five surveys in the period May – October 2014. Additional surveys were carried out at night. During each survey, the fish assemblage was expressed as fish density per surface area (electro data) and catch per unit effort (fyke data).

All pilot sites were investigated on the effect of large wood structures for macro-invertebrates. Different sampling methods were tested: One entire tree was sampled by lifting it from the fishway and washing it, but also less extensive sampling methods including subsampling of branches and prepared excisions of bark were tested. For all sampling methods the surface was measured (excisions) or estimated (entire tree, branches). The collected macro-invertebrates were conserved in 96% ethanol and identified to the species level.

Results

Fish

Total fish densities were comparable at the large wood sites and the reference sites (groyne banks), both based on electro fishing and on fyke nets (Fig 3).

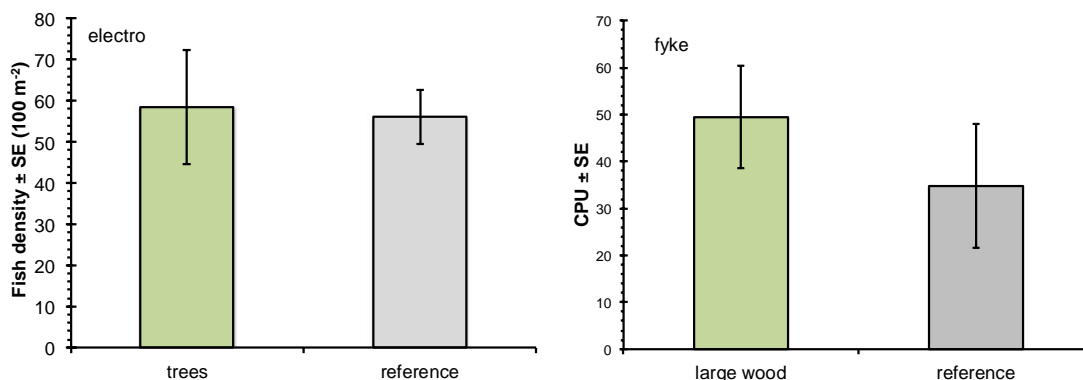

Figure 3: Total abundance of the fish community near the trees and at the control sites based on electro fishing and fyke net trapping (Dorenbosch *et al.* 2014).

Considering the species composition does reveal a significant difference between the two sites: Diversity and species richness are higher around the large wood structures than at the control sites. Invasive species dominate the rip-rap at the groyne fields, whereas native species are most abundant near the trees (Fig. 4). The fish community in the groyne fields is dominated by the alien round goby (*Neogobius melanostomus*). The fish community around the trees is composed more evenly, and consists of mainly native species. This is confirmed by additional camera observations that showed high juvenile fish concentrations around the trees, especially between the branches.

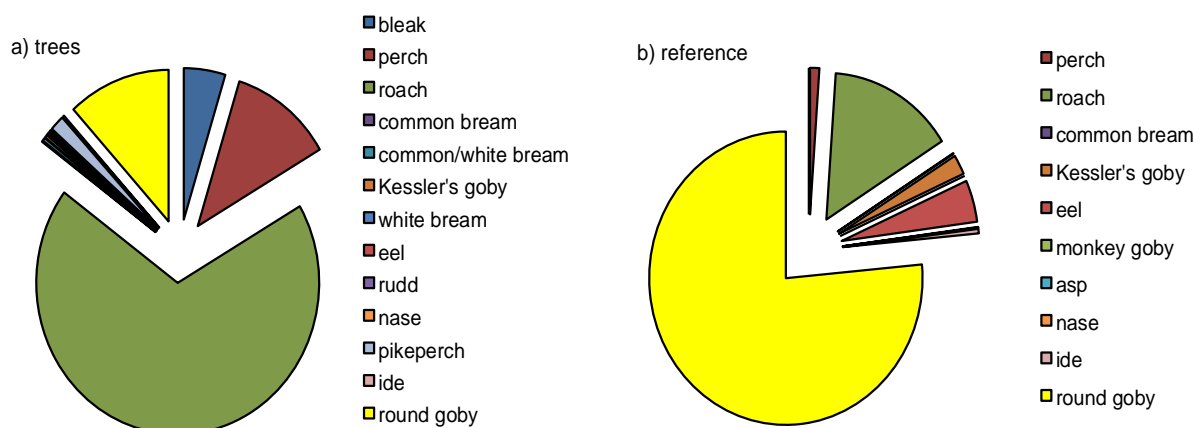

Figure 4: Fish densities per species (relative to total abundance) near the trees and at the control sites during daytime and night in September 2014, based on electro fishing (Dorenbosch *et al.* 2014).

Fish densities at the wood decrease towards the night, when juvenile fish leave their refuge to forage in open water (Fig. 5). Species composition then shifts from dominance by juvenile roach to a dominance by adult piscivorous species as eel, perch and pike. Densities at the reference site tend to increase at night. Near the groynes the fish community is dominated by round goby both during day and night (Dorenbosch *et al.* 2014).

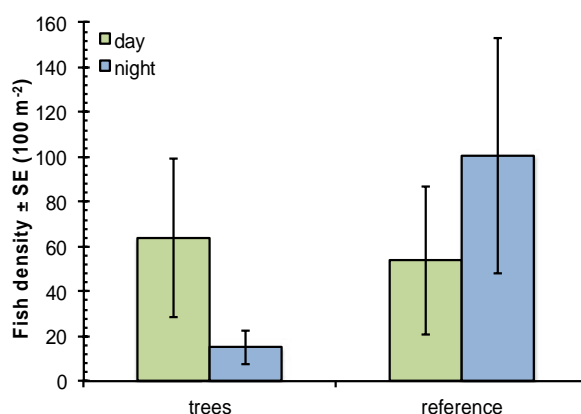

Figure 5: Densities (numbers per 100 m²) of fish near the trees and at the control sites during daytime and at night in September 2014, based on electro fishing (Dorenbosch *et al.* 2014).

Macro-invertebrates

On the wood, several characteristic riverine species were found, such as caddisflies (Trichoptera) and Chironomidae (Diptera), among which several xylophagous (wood-feeding) species that are missing on the rip-rap in the river (Klink, 2014). On the trees in the shallow groyne-field a single individual of the caddisfly *Psychomyia pusilla* has been identified, a formerly common riverine species, that was absent in the river Rhine and Meuse since 1934. The trees in the deep erosion pits are dominated by species from the riverbed, indicating sedimentation of sand and silt on these trees, which is confirmed by visual observations. The tree in the fishway is dominated in spring by species that feed on the diatoms growing on the *Cladophora* algae on the bark (Fig. 6). Many rare Chironomid species were found here in spring, such as *Diamesa insignipes*. In September

the *Cladophora* has vanished and the rare species were replaced by more common diatom-grazing Chironomidae (Klink, 2014). Despite the short period of colonization and unfavorable effects as silt deposition, large wood contributes positively to the EQR score of the Water Framework Directive (Fig. 7).



Figure 6: Dense mat of *Cladophora* algae on the bark of the tree (Klink, 2014).

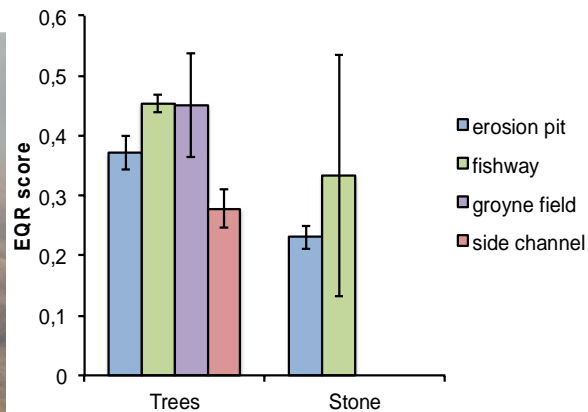

Figure 7: EQR score per habitat and location with 95% confidence intervals (Klink, 2014)

Discussion and conclusions

Large wood structures at the pilot sites have a significant ecological value for habitat availability for native species in the Nederrijn-Lek. Densities of native species are higher near the trees, while the traditional rip-rap banks are dominated by alien goby species. The variation in natural habitat structures of the trees leads to a higher level of species richness than the control sites. The shifts in fish density between night and day indicate that fish use the large wood structures for shelter during daytime. This is confirmed by the camera-observations that show large concentrations of mainly juvenile fish between the branches. The trees also have a function for foraging: fish feed on the algae and macro-invertebrates on the trees and also piscivorous fish are attracted to the trees due to the availability of prey fish. The large numbers of juveniles indicate that fish may also use the trees as a spawning area. This will be investigated more intensively in 2015.

As macro-invertebrates are concerned, close relations are found between particular species and the nature of the substrate. The positive indications at the species level may lead to a positive effect on WFD goals, as many of the newly found species are considered target species for the WFD. Sites that are in direct connection with the main channel appear to show better results than side waters. These indications have to be confirmed by future research over a longer period though, as there may also be a pioneer-effect. For example bivalves as *Dreissena polymorpha* and *D. rostriformis bugensis*, that dominate the rip-rap banks, need more time to develop, which may negatively impact the WFD goals especially if this also leads to establishment of alien species as the killer shrimp *Dikerogammarus villosus*.

Future

The results indicate that the first phase of colonization is prosperous. We now follow this process, to find out if the native fauna on the large wood structures persists, despite the pressure from alien invading species.

If future monitoring results confirm that the LWD contribution to biodiversity in navigable rivers persists and the fixation methods prove to be adequate, the measure will be applied in faster flowing parts of rivers, and to flowing side-channels. Under those circumstances, we expect even more interesting results, by large wood enhancing and changing morphodynamic processes such as erosion and sedimentation (Gurnell *et al.* 1995, Roni *et al.* 2015). Also new pilot studies are being prepared in which large wood is applied in river training constructions.

References

- Dorenbosch, M., J.H. Bergsma & W.M. Liefveld (2014). Ecological functioning of dead trees for fish in a large navigable river in the Netherlands. Evaluation of a pilot-experiment in 2014 (in Dutch). Waardenburg BV, Culemborg, the Netherlands. Report 14-251.
- Gerhard, M. & M. Reich (2000). Restoration of streams with large wood: effects of accumulated and built-in wood on channel morphology, habitat diversity and aquatic fauna. *Internat. Rev. Hydrobiol.* 85 (1), 123-137.
- Gurnell A.M., K. J. Gregory & G. E. Petts (1995). The role of coarse woody debris in forest aquatic habitats: Implications for management. *Aquatic Conservation* 5 (2), 143-166.
- Kail J., D. Hering, S. Muhar, M. Gerhard & S. Preis (2007). The use of large wood in stream restoration: experiences from 50 projects in Germany and Austria. *Journal of Applied Ecology* 44 (6), 1145.
- Klink, A.G. (2014). Dead trees (LWD) experiment in large navigable rivers in the Netherlands as a tool for ecological rehabilitation in WFD context. Evaluation of the first year, 2014 (in Dutch). Hydrobiologisch Adviesburo Klink Rapp. Med. 138.
- Miller S.W., P. Budy & J.C. Schmidt (2010). Quantifying macroinvertebrate response to in-stream habitat restoration: applications of meta-analysis to river restoration. *Restoration Ecology*, 18, 8-19.
- Piégay, H. & A. Gurnell (1997). Large woody debris and river geomorphological pattern: examples from S.E. France and S. England. *Geomorphology* 19: 99-116.
- Roni, P., T. Beechie, G. Pess & K. Hanson (2015). Wood placement in river restoration: fact, fiction, and future direction. *Can. J. Fish. Aquat. Sci.* 72:466-478.

Management of a meander cutoff using instream works to reduce the hydraulic gradient

Morris S & Broderick T

SHAUN MORRIS

*North Coast Local Land Services, 24 Gordon Street,
Coffs Harbour, NSW 2450 Australia*

TONY BRODERICK

*North Coast Local Land Services, 49 Victoria Street,
Grafton, NSW 2460, Australia*

ABSTRACT

As a consequence of aggregate extraction in the adjacent floodplain and greater Orara River area along with degraded riparian vegetation within the entire reach, a bed level incision in a secondary channel of the Orara River in Northern New South Wales promoted the disconnection of low to medium flows through a 1200m section of the primary channel. This effectively produced a 40% reduction in channel length and subsequent 40% increase in channel gradient. Over a period of 13 years local catchment managers utilised a number of small grants, partnership arrangements and government funds to commission a series of geomorphic studies and instream works that aimed to stabilise the secondary channel and return flows to the primary channel. Works included innovative pin groynes and engineered deflector jams to promote aggregation of bed material and over time lower the gradient of the secondary channel. A rock ramp was then installed to consolidate the head of the secondary channel returning low to medium flows through the primary channel. But these efforts were not without risk or failure as works were undertaken between major flooding events which progressively modified the priorities for works within the site. Design of works were undertaken in conjunction with an appreciation of the life history requirements of native fish, in particular the Eastern Freshwater Cod (*Maccullochella ikei*), a locally found endangered fish heavily reliant on stable geomorphic conditions. Conducted as part of a wider analysis of native fish movement in the Clarence River Catchment, the NSW Fisheries Project 'Fishtrack', was utilised to inform the effectiveness of works in promoting fish passage through the study site.

INTRODUCTION

Located in North East New South Wales Australia, the Orara River like many South East Australian streams has experienced a number of significant planform and cross sectional modifications following changes to catchment boundary conditions (Cohen, 2004). These changes have occurred due to the loss of riparian vegetation and large woody debris as well as gravel extraction (Cohen, 2004). Rainfall in the area is high in the headwater regions (1880mm) with a maximum elevation of 920m in the rugged hill country of the Upper Orara. Overland flow effects are exacerbated with much of the valley floor countryside cleared of vegetation. The thresholds for bedload transport are exceeded during flows as low as 40m³/s, with peaks over threshold (208m³/s) occurring roughly every 2 years (Cohen, 2004).

Gravel extraction was active in the Orara River from 1978 however some reports suggest this began a lot earlier. Gravel extraction from the floodplain adjacent to the study site is thought to have occurred from 1984. The 730m³/s flood of 1989 produced extensive erosion in and around the area of the extraction site and by 2002 the secondary channel adjacent to pit had become the primary channel for flows.

This bed level incision along the secondary channel progressed over a distance of 350m to its confluence with the primary channel creating a meander cutoff effectively eliminating the majority of flows along a 1200m section of the Orara River and raising the gradient of the primary flow path by 40% (Figure 1).



Figure 1. Map of study site showing the gravel extraction site, primary and secondary channels. Flow path is from lower left to right.

Between 2000 and 2014 a series of instream works sought to raise the bed level of the secondary channel and direct flows along the primary channel using a range of roughness enhancing and hydraulic gradient control works. The final structure was built at the confluence of the secondary and primary channels in 2014 effectively closing one of the longest running instream project work sites in the region.

The Orara River is one of the last known habitats of the Endangered Eastern Freshwater Cod (*Maccullochella ikei*), one of Australia's largest freshwater fish capable of growing to over 30kg and 800mm in size (Morris et al., 2001). This species with its low fecundity and restricted range and abundance, is heavily reliant on instream structure and therefore stable geomorphic conditions for successful breeding and recruitment (Morris et al., 2001). This project aimed to restore the pathway of flow along the meander to re-

establish stable geomorphic conditions within the reach and by doing so provide the necessary biophysical life history requirements of this endangered fish.

Scope and Objectives of Study

The following issues form the objectives of the project:

1. Examine the relationship between historical changes, aggregate extraction activities and current channel morphology of the site and identify works required to aggrade and stabilise bed material in the meander cutoff (secondary channel)
2. Restore flows through the meander by undertaking a series of works in the secondary channel

Methods

Surveys

In 2004 the University of NSW were contracted to undertake a geomorphic analysis of the study site as part of a wider reach analysis of the Orara River in 2004 (Cohen, 2004). This identified:

1. Historical channel changes on the Orara River
 - a. Planform changes at the study site
2. Current valley and channel morphology of the Orara River
 - a. Valley floor morphology
 - b. Channel morphology
 - c. Riffled-pool morphology and a longitudinal profile analysis
 - d. Distribution and role of flood channels on the Orara River
3. Past Rehabilitation techniques and future implications
 - a. Recent bed level changes at the study site
 - b. Effectiveness of remedial structures at the study site
 - c. Sediment sinks and sources on the Orara River
 - d. Implications for future rehabilitation strategies on the Orara River
4. Recommendations for rehabilitation of the Orara River including the study site.

Works

This geomorphic analysis qualified efforts undertaken in previous years and reinforced the principle theory behind the ongoing application of works in the secondary channel which sought to ensure high flows going down the primary channel were enough to create a reduced hydraulic gradient in the secondary channel. When flows leaving the secondary channel were being backed up by virtue of hitting an appropriate level of water in the primary channel, this would provide a reduced hydraulic gradient in the secondary channel and promote deposition. Between 2000 and 2014, limited by the timing and size of available funds project staff installed a number of staged instream works to exercise this theory and accelerate bed level rise. These included two large channel spanning engineered logjams strategically placed at the head of the secondary channel and 75m downstream to promote flows through the primary channel during high flow events. Additional pin groynes and logjams were installed at strategic locations along the length of the secondary channel to reduce bed and bank erosion, promote point bar accretion, consolidate available bed load and reduce overall stream power.

Additional pin groynes; one channel spanning double pin row and a series of smaller pin rows were placed 75m upstream from downstream end of the secondary channel to

consolidate and armor a wider point bar in order shift the thalweg to river right thereby increasing sinuosity and reducing stream power. This flow path had been reinforced with a series of pin rows in previous years to increase channel roughness and dissipate flow energy. Following the stabilisation of this lower end of the channel and expected gradual decay of the two channel spanning logjams in previous years, a large rock ramp was installed in 2014 at the head of the secondary channel to again promote the majority of flows through the primary channel and dissipate the energy of flows entering the secondary channel.

Results

Initial works were successful in halting bank erosion following the bed level incision and promoted the commencement of deposition within the secondary channel, effectively creating a more stable reach for further works to occur. The series of pin groynes placed within the last 100m of the secondary channel created a large point bar that has to date raised the bed level by approximately 2m in this section and shifted the thalweg to river right to within a consolidated area, increasing sinuosity and providing a reduced hydraulic gradient within the secondary channel. A pool immediately upstream of this section has remained intact and has been observed to act a drought refuge / backwater habitat for a range of native fish species. The banks within this section are now stable and well vegetated. An armored riffle has formed upstream of the pool and a second stable pool has been maintain upstream of this (roughly 50m downstream of the rock chute). The rock chute has successfully endured a number of over topping flood events, is considered stable and effectively promotes an appropriate amount of flow during high flow events through both channels but principally through the primary channel during low to medium flow events. This in turn has returned viable habitat conditions through 1200m of the Orara River, effectively increasing by a factor 4 the amount of available habitat for native fish. This was confirmed by pit tag tracking of eastern freshwater cod and Australian bass through the meander in recent seasons.

Conclusions and recommendations

The principle theory behind staging the above works to initially stabilise bank erosion and promote the commencement of deposition within the lower half of the secondary channel proved effective in creating the conditions necessary to reduce the hydraulic gradient within the reach. Works during these early stages ensured that flows leaving the secondary channel were hitting an adequate level of flows moving along the primary channel. Managing the hydraulic gradient within the reach proved critical in reducing stream power within the secondary channel and was the key in promoting deposition. Therefor aligning works with consideration of improving channel stability by virtue of manipulating the hydraulic gradient is an effective way of returning flows to a meander and stability to a meander cutoff following significant bed lowering and increased stream power.

References

- Cohen, T. (2004). A geomorphic analysis of the Orara River – Cochrane's Pool to Coramba. School of Earth and Environmental Sciences. University of Wollongong.
- Morris, S.A., Pollard, D.A., Gehrke, P & Pogonoski, J. (2002). Threatened and Potentially Threatened Freshwater Fish of the Murray-Darling Basin and Coastal New South Wales - Report to World Wide Fund for Nature and Fisheries Action Program. NSW Fisheries Office of Conservation.

Quantifying and valuing river restoration effects: Thur and Töss Rivers

Paillex A et al

AMAEL PAILLEX¹, NELE SCHUWIRTH¹, ARMIN LORENZ², KATHRIN JANUSCHKE², ARMIN PETER³ & PETER REICHERT¹

¹SIAM department, Eawag, Swiss Federal Institute of Aquatic Science and Technology, CH-8600 Duebendorf, Switzerland.

²University of Duisburg-Essen, Department of Aquatic Ecology, D-45117 Essen, Germany.

³Fish ecology and evolution department, Eawag, Swiss Federal Institute of Aquatic Science and Technology, CH-6047 Kastanienbaum, Switzerland.

Summary

We used multi-attribute value theory to combine existing and newly suggested river assessment protocols to evaluate effects of river restoration projects on the physical, chemical, biological and the overall ecological state of two restored rivers in Switzerland, the Thur and the Töss Rivers. We evaluated the effect of restoration on habitat conditions, water quality, and five aquatic and terrestrial organism groups. In our case studies, the morphological conditions and the biological state improved with restoration, with the largest effect detected for ground beetles and fish communities, followed by benthic invertebrates, riparian vegetation and aquatic vegetation. Uncertainty analysis showed that the positive effects of restoration on the physical and biological states were significant, and the overall ecological state of the studied river sites also improved significantly with restoration. Multi-attribute value theory proved to be a useful framework to value restoration effects and to visualize the effect at the integrative and the organism group levels. Propagation of uncertainty was important to assess the significance of the improvements.

Introduction

While the number of river restoration projects increases, decision tools for river management and integrative methods for valuing river restoration effects are scarce. Moreover, studies quantifying river restoration effects often rely on one or few assessed organism groups, and the effects on terrestrial biodiversity is often neglected. For this research, we selected five organism groups (fish, benthic invertebrates, aquatic vegetation, ground beetles, and riparian vegetation) to quantify the effect of restoration on aquatic and terrestrial communities. We used multi-attribute value theory to combine an existing river assessment program with newly suggested assessment protocols to get a more comprehensive assessment of the effect of two restoration projects in Switzerland (Reichert *et al.* 2015). In this study, we addressed four goals: 1) to quantify restoration effects on habitat diversity and on aquatic and terrestrial communities, 2) to analyze the suitability of existing river assessment protocols to assess the effects of restoration, 3) to value the effect of river restoration on organism groups not included in existing river assessment systems, and 4) to provide a framework that considers uncertainty and can easily be integrated into decision support tools for river management.

Material and Methods

In 2002, a 1.5km section of the Thur River and its floodplain was intensively restored. The river was widened on one side of the main river channel. Embankments along the

right side of the river were removed to provide more space to the river in an area where levees were absent already before restoration (Fig. 1 a-b). Additional artificial structures were added to enhance the ability of the river to braid. The dynamic processes were expected to return, with natural patterns of erosion and deposition, better connection between the main river channel and the floodplain, and recreation of secondary channels. The second river was restored on a distance of 200 m (Töss River: small restoration effort, restoration date 1999). Restoration aimed at improving the hydromorphological conditions by lowering the floodplain and removing the embankments to provide more space for the river (Fig. 1 c-d).



Figure 1. Illustration of channelized and restored sections of the Thur and Töss Rivers. Thur channelized (a), Thur restored (b), Töss channelized (c), Töss restored (d). Coordinates Thur: 47.5918 (N) 8.77114 (E) and Töss: 47.46338 (N) 8.72825 (E).

To assess the effect of restoration on the ecological state of the rivers, we translated existing assessment procedures for Swiss rivers (Bundi et al. 2000) into value functions (Langhans et al. 2013) using the R-packages "utility" (Reichert, Schuwirth & Langhans 2013) and "ecoval" (Schuwirth & Reichert 2014). For the biological state, we used existing assessment procedures developed for aquatic macroinvertebrates and fish (Schager & Peter 2004; Stucki 2010) and developed new value functions for ground beetles, riparian vegetation and aquatic vegetation (Fig. 2 gives an example of value functions). The objectives hierarchies for ground beetles, riparian and aquatic vegetation follow the same scheme. A good state regarding those organism groups considers the sub-objectives of a good near natural community structure, the presence of threatened species, and the absence of alien species. To account for the complementarity of the sub-objectives at the lowest hierarchical level, we used an additive-minimum aggregation technique (Fig. 2 panel c) (Langhans, Reichert & Schuwirth 2014). Uncertainty about attribute values was considered by formulating the uncertain knowledge as probability distributions.

Results

All organism groups showed a higher richness in restored reaches compared to the degraded reaches, except for the aquatic vegetation in the Töss River, which decreased in richness, and the fish in the Töss, which did not change in richness. The morphological state of the case studies improved with restoration from moderate and poor conditions in the Thur and the Töss, respectively, to very good in the restored sections of both rivers (Fig. 3, second column). All organism groups improved with restoration, except the aquatic vegetation which deteriorated in both rivers (Fig. 3, last column). The aquatic vegetation showed a negative response due to a lower richness in the Töss River and the occurrence of an invasive species (i.e. *Elodea nuttallii*) in the restored reach of the Thur. Ground beetles and fish communities improved most, followed by riparian vegetation and benthic invertebrates (Fig. 3, columns 9-12). The ecological state of both rivers increased

toward a moderate state for the Thur and a good state for the Töss River (Fig. 3, first column). We found large uncertainty ranges around median values for results concerning aquatic macroinvertebrate communities and aquatic vegetation compared to the others organism groups. For both rivers, the improvement of the ecological state due to restoration was significant, even when doubling the uncertainty of the attributes.

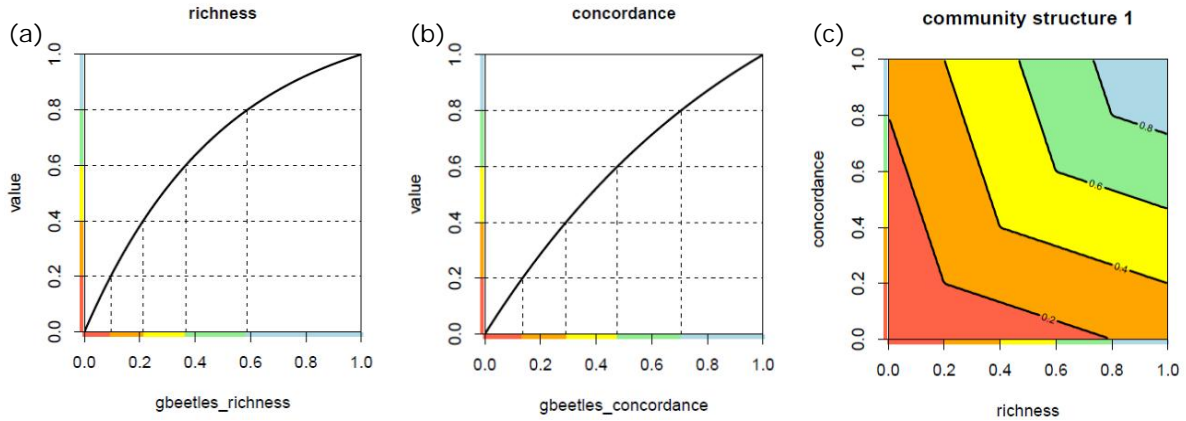

Figure 2. Assessment valuation exemplified for ground beetles. (a): value function for richness. (b): value function for concordance of observed richness compared to the expected one. (c): additive-minimum aggregation technique to combine valuation of richness and concordance toward higher hierarchical levels.

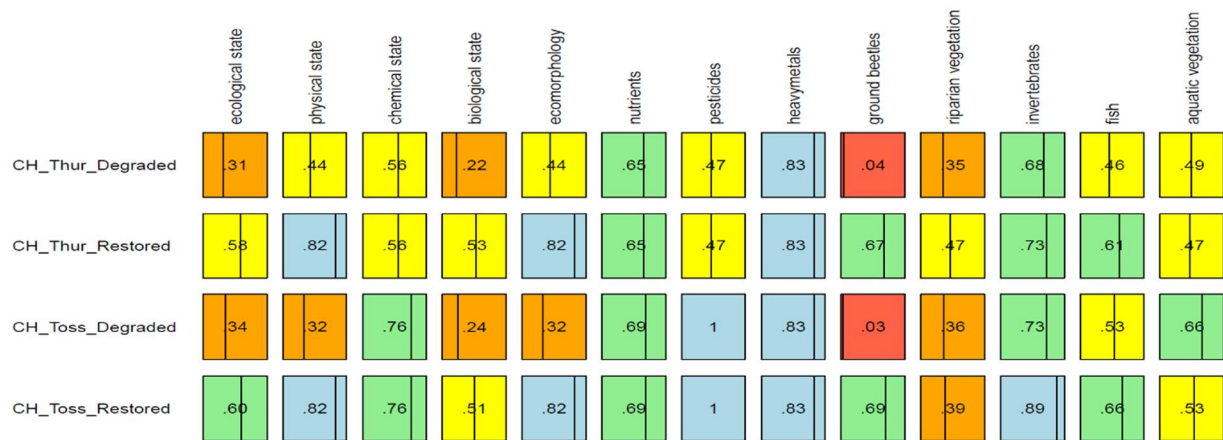

Figure 3. Ecological assessment of degraded and restored reaches of the Thur and the Töss Rivers. Vertical black lines and numbers represent mean values and colors belong to five classes equally distributed from 0 (worst condition) to 1 (best condition), similar to the commonly used ones for ecological quality classes in Europe (red = bad, orange = poor, yellow = moderate, green = good, blue = very good).

Discussion and conclusion

- All organism groups benefited from restoration to different degrees, except for the aquatic vegetation. Improvement was most pronounced for ground beetles, which benefited from recreation of gravel bars following the river widening. While reduction of the ecological gain by restoration for some organism groups was attributed to the presence of invasive species. Propagation of uncertainty showed that the positive effect of restoration on the physical and biological states were significant. Improvements were, however, uncertain in some cases for benthic invertebrates and riparian vegetation. However, the overall ecological state of the studied river sites improved significantly with restoration.
- Assessment procedures were originally developed to describe the ecological state of the rivers, but since restoration aims to improve the ecological state, we showed that they are also useful to detect restoration success. In this regard, integrative valuation with value functions showed to be useful and propagation of uncertainty helped to evaluate the significance of the measured improvement linked to restoration. Application of the proposed assessment method to other river restoration monitoring programmes will help to infer cause-effect relationships between physical and biological changes, answering the question to which degree a restoration effort should be made to reach a desired level of biological or ecological improvement.

References

- Bundi, U., Peter, A., Frutiger, A., Hutte, M., Liechti, P. & Sieber, U. (2000) Scientific base and modular concept for comprehensive assessment of streams in Switzerland. *Hydrobiologia*, 422, 477-487.
- Langhans, S., Reichert, P. & Schuwirth, N. (2014) The method matters: A guide for indicator aggregation in ecological assessments. *Ecological Indicators*, 45, 494-507.
- Langhans, S.D., Lienert, J., Schuwirth, N. & Reichert, P. (2013) How to make river assessments comparable: A demonstration for hydromorphology. *Ecological Indicators*, 32, 264-275.
- Reichert, P., Langhans, S., Lienert, J. & Schuwirth, N. (2015) The Conceptual Foundation of Environmental Decision Support. *Journal of Environmental Management*, 154, 316-332.
- Reichert, P., Schuwirth, N. & Langhans, S. (2013) Constructing, evaluating and visualizing value and utility functions for decision support. *Environmental Modelling & Software*, 46, 283-291.
- Schager, E. & Peter, A. (2004) Fish - Level I. Méthodes d'analyse et d'appréciation des cours d'eau en Suisse. *L'environnement pratique n°44* (eds FOEN), pp. 63. Berne.
- Schuwirth, N. & Reichert, P. (2014) ecoval: Procedures for Ecological Assessment of Surface Waters. (eds CRAN).
- Stucki, P. (2010) Macroinvertebrates - Level I. Méthodes d'analyse et d'appréciation des cours d'eau en Suisse. *L'environnement pratique n°1026* (eds FOEN), pp. 61. Berne.

Helophytes are efficient indicators of river restoration success

Scheunig S. D. et al.

SABINE D. SCHEUNIG¹, ANNETTE BAATTRUP-PEDERSEN², FRAUKE ECKE³, SEPPO K. HELLSTEN⁴, JAN KÖHLER¹, ARMIN W. LORENZ⁵ & JAANA RÄÄPYSJÄRVI⁴

¹*Department of Ecosystem Research, Leibniz-Institute of Freshwater Ecology and Inland Fisheries Müggelseedamm 301, D-12587 Berlin, Germany.*

²*Department of Bioscience, Aarhus University. Vejlssøvej 25, P.O. Box 314, DK-8600 Silkeborg, Denmark.*

³*Department of Aquatic Sciences and Assessment, Swedish University of Agricultural Sciences. P.O. Box 7050, S-750 07 Uppsala, Sweden.*

⁴*Finnish Environment Institute SYKE, Freshwater Centre, P.O. Box 413, FI-90014 University of Oulu, Finland.*

⁵*Department of Aquatic Ecology, University of Duisburg-Essen. Universitätsstraße 5, D-45141 Essen, Germany.*

River banks in Europe are often artificially altered for river regulation purposes, contributing to general river degradation. In the course of river restoration, removal of bank reinforcements and widening of the banks is often conducted to improve lateral connectivity between the riverbed and the adjacent floodplain. In order to stimulate evaluation following river restoration and thus to increase knowledge on the outcome of restorations, we aim to identify cost-efficient ways of its assessment. So far, helophytes being plants growing on the edge of waterbodies have only rarely been considered as a measure of restoration success, but we assume that their diversity strongly responds to restoration. To test this assumption, we gathered data on helophytes in 20 restored river sections distributed throughout Europe. Samplings and surveys in both restored and adjacent degraded reaches of each river allowed for the evaluation of restoration outcome. Median richness (+92%) and median Shannon diversity (+38%) of helophytes were higher in the restored compared to the degraded reaches. Given this clear response, we encourage water managers to consider helophytes as a measure to evaluate the outcome of river restoration. However, this measure should be combined with an evaluation of the nativeness of the helophyte community.

Introduction

River restoration projects often lack post-project monitoring (Bernhardt et al., 2005). As a consequence, potential knowledge on how to conduct ecologically sustainable restoration is lost. Scientists and water managers only slowly gain practical experience in this field, which is essential for cost-effective planning of future restoration projects (Katz et al., 2007).

One of the reasons for restoration projects not being evaluated is the lack of funding (Bernhardt et al., 2005). To increase monitoring activities, we therefore aim to identify new cost-efficient ways for assessing restoration success building on simple low-cost measures. Specifically we hypothesised that helophytes as emergent plants living in shallow habitats near the river banks reflect the status of this transition zone. An improvement of this habitat is often desired to enhance land-water interactions following river restoration (Merenlender and Matella, 2013). We assumed that species richness and

diversity of the helophyte community should increase after restoration. To test this, we analysed the communities in restored river sites applying a control-impact approach.

Methods

Twenty river restoration sites located in nine European countries, covering a wide range of degradation, environmental conditions, geographical settings and restoration intensities, were used as study sites. Sampling was performed in restored reaches as well as in nearby degraded reaches upstream of the restored sections allowing for a quantification of the restoration effect on the helophyte community. Details of the restoration sites can be found in Hering et al. (in revision).

Sampling took place during the peak of macrophyte growth in summer. At each site, a representative sampling stretch of 200 m was chosen in the restored and upstream degraded section. We mapped all macrophytes within this stretch which were inundated for at least 85% of the year and recorded their abundance according to a 5-point abundance scale, based on their coverage (see Table 1). We identified the plants at species, but at least at genus level. Because of the existence of multi-layer communities total coverage at a site might exceed 100%. Depending on water flow and depth, inspection was carried out from a boat or by wading. To ensure completeness of the macrophyte list, we walked alongside both banks. For further details of the procedure, see Poppe et al. (2012).

Macrophytes were then classified according to their growth forms (Den Hartog and Van der Velde, 1988; Wiegleb, 1991). Species richness and Shannon diversity (based on the mean coverage within each abundance class, see Table 1) of helophytes were calculated using the package BiodiversityR (R Core Team, 2014) in RStudio (Kindt and Coe, 2005).

Table 1. 5-point abundance scale applied in macrophyte sampling. Relative abundances of less than 1% are not recorded.

Abundance class	Coverage [%]	Mean coverage within class [%]
1	1 – 5	3
2	5 – 25	15
3	25 – 50	37.5
4	50 – 75	62.5
5	75 – 100	87.5

Results

We found 71 different helophyte species at our restoration sites, varying between 1 and 22 species per site. For 14 sites, richness was higher in the restored than in the corresponding degraded sections, while the opposite was true for 3 sites. For another 3 sites, we could not find any difference in richness.

For all sites combined, species richness and Shannon diversity in restored sections were 91.7% and 38.5% (medians), respectively, higher than in their corresponding degraded sections. The differences were more pronounced for sites where restoration was conducted more intensively (length of the restored section, river compartments included, "large-scale", although the differences were significant for almost all groups (Wilcoxon signed-rank test with a 95 % confidence interval). Only for small-scale restoration sites, we could not find any significant difference in richness, but a very strong trend for richness being higher in restored than in degraded reaches (Wilcoxon signed-rank test, $n=10$, $p=0.055$).

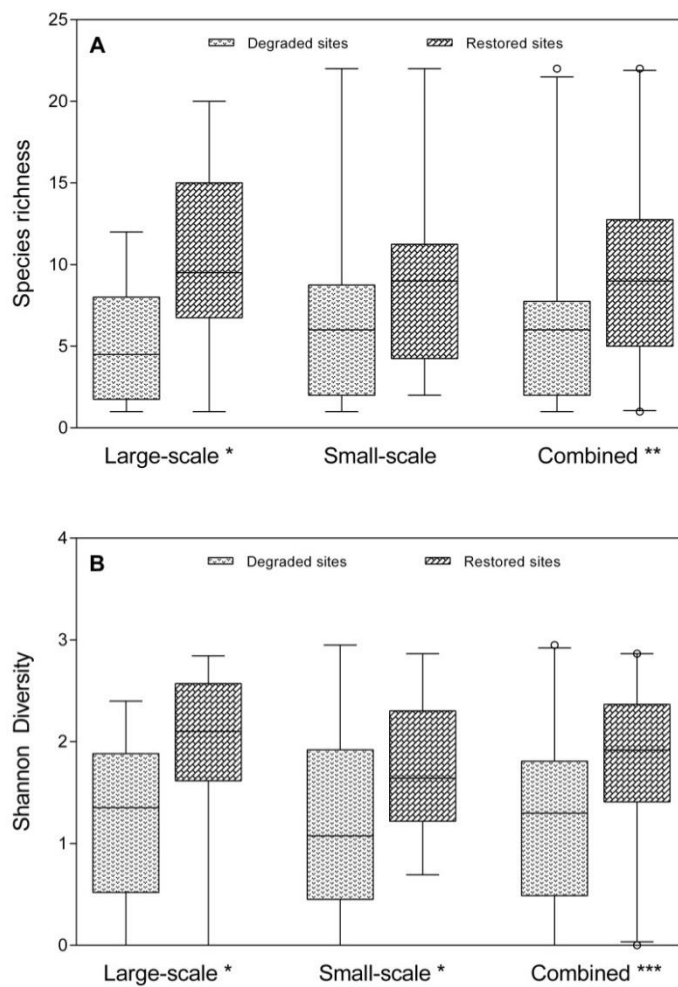

Figure 1. Species richness (A) and Shannon diversity (B) of helophyte communities in degraded and restored reaches of large-scale ($n=10$), small-scale ($n=10$) and all restoration sites combined ($n=20$). Boxes cover the range from the lower to the upper quartile with the median marked, whiskers show the 5 and 95 percentiles, dots denote outliers. Significant differences in richness or diversity between degraded and restored reaches are indicated by asterisks beside the groups of sites (Wilcoxon signed-rank test: * $p<0.05$; ** $p<0.01$; *** $p<0.001$).

Discussion

Analysing species richness and Shannon diversity at 20 river restoration sites across Europe, we found a positive effect of restoration on helophyte communities (for details, see Scheunig et al. (in preparation)). However, their response to restoration was variable. Lorenz et al. (2012) suggested that helophytes indicate river restoration success in mountain, but not in lowland rivers. In contrast, we found overall positive responses in our study consisting of the analysis of sites in both mountain and lowland rivers, obviously as a consequence of large geographical variation. This controversy reflects the complex interactions of many environmental and restoration parameters (e.g. time since restoration) controlling helophyte diversity.

In addition, different ways of conducting river restoration among the analysed projects might have caused the variation in richness and diversity responses. Our compilation of restoration projects is heterogeneous in terms of restoration measures performed. Widening and removal of bank fixations increase and flatten the transition zone between the riverbed and the surrounding area. Therefore, these measures enhance the area of shallow habitats and habitat diversity (Poppe et al., in revision), creating new niches for helophytes. On the other hand, measures solely affecting the central part of the channel should have only minor effects if any on the helophytes.

The impact of both varying restoration parameters (e.g. type of measure, restoration size) and environmental conditions (e.g. discharge, mountain vs. lowland rivers) on the helophyte community is currently under investigation (Scheunig et al., in preparation).

As representatives of biota living in the water level fluctuation zone, helophytes reliably reflect improvements in connectivity between the active channel and the adjacent area, which is an important aim in river restoration. For a taxonomist, the mapping of helophytes is a cost-efficient measure to conduct. Depending on the type of restoration measure, we therefore encourage water managers to consider helophytes as a suitable organism group to use evaluate the outcome of river restoration in terms of a more natural land-water ecotone. However, this measure should be combined with an evaluation of the nativeness of the helophyte community to avoid wrong conclusions.

References

- Bernhardt, E.S., Palmer, M.A., Allan, J.D., Alexander, G., Barnas, K., Brooks, S., Carr, J., Clayton, S., Dahm, C., Galat, D., Gloss, S., Goodwin, P., Hart, D., Hassett, B., Jenkinson, R., Katz, S., Kondolf, G.M., Lake, P.S., Lave, R., Meyer, J.L., Donnell, T.K.O., Pagano, L., Powell, B., Sudduth, E. (2005). Synthesizing U.S. river restoration efforts. *Science* 308: 2–3
- Den Hartog, C., Van der Velde, G. (1988). Structural aspects of aquatic plant communities. In: Symoens JJ (ed) *Vegetation on Inland Waters - Handbook of Vegetation Science*. Kluwer Academic Publishers, Dordrecht, The Netherlands, pp. 113–155
- Hering, D., Aroviita, J., Baattrup-Pedersen, A., Brabec, K., Buijse, T., Ecke, F., Friberg, N., Gielczewski, M., Januschke, K., Köhler, J., Kupilas, B., Lorenz, A., Muhar, S., Paillex, A., Poppe, M., Schmidt, T., Schmutz, S., Vermaat, J., Verdonschot, P., Verdonschot, R. Contrasting the roles of section length and instream habitat enhancement for river restoration success: A field study on 20 European restoration projects. *Journal of Applied Ecology*, in revision
- Katz, S.L., Barnas, K., Hicks, R., Cowen, J., Jenkinson, R. (2007). Freshwater Habitat Restoration Actions in the Pacific Northwest: A Decade's Investment in Habitat Improvement. *Restoration Ecology* 15: 494–505

- Kindt, R., Coe, R. (2005). Tree diversity analysis. A manual and software for common statistical methods for ecological and biodiversity studies. World Agroforestry Centre (ICRAF), Nairobi, Kenya
- Lorenz, A.W., Korte, T., Sundermann, A., Januschke, K., Haase, P. (2012). Macrophytes respond to reach-scale river restorations. *Journal of Applied Ecology* 49: 202–212
- Merenlender, A.M., Matella, M.K. (2013). Maintaining and restoring hydrologic habitat connectivity in mediterranean streams: an integrated modeling framework. *Hydrobiologia* 719: 509–525
- Poppe, M., Kail, J., Aroviita, J., Stelmaszczyk, M., Gielczewski, M., Muhar, S. Assessing restoration effects on hydromorphology in European mid-sized rivers by key hydromorphological parameters. *Hydrobiologia*, in revision
- Poppe, M., Stelzhammer, M., Seebacher, M., Muhar, S., Januschke, K., Lorenz, A., Kupilas, B., Hering, D. (2012). REFORM D4.1 - Field protocols and associated database. Vienna
- R Core Team (2014). R: A language and environment for statistical computing
- Scheunig, S., Baattrup-Pedersen, A., Ecke, F., Hellsten, S.K., Köhler, J., Lorenz, A.W., Rääpysjärvi, J. (in preparation). Helophytes are efficient indicators of river restoration success
- Wiegand, G. (1991). Die Lebens- und Wuchsformen der makrophytischen Wasserpflanzen und deren Beziehungen zur Ökologie, Verbreitung und Vergesellschaftung der Arten. *Tuexenia* 11: 135–147

Effects of hydromorphological stream restoration measures on stream and riparian zone plant diversity

Fraaije R. G. A. et al.

ROB G.A. FRAAIJE, JOS T.A. VERHOEVEN & MEREL B. SOONS

*Department of Biology, Utrecht University, Padualaan 8
Utrecht, 3584 CH, the Netherlands*

Streams and their riparian zones provide typical examples of naturally species-rich, dynamic habitats. Under natural conditions, spatial and temporal variation in flooding disturbance coincide with a strong hydrological gradient from the channel to the uplands, generating a heterogeneous environment with corresponding high plant and animal diversity (Naiman & Decamps 1997). Yet, streams and their riparian zones are highly vulnerable freshwater systems which are increasingly threatened across the world by anthropogenic modifications, such as damming and channelization, as well as by projected increases in climate-induced droughts and flash floods (Garssen et al. 2014 & 2015). Severe losses of diversity along streams and their riparian zones, and the lack of ecological improvement after costly restoration programs (Verdonschot & Nijboer 2002; Jähnig et al. 2010; Brederveld et al. 2011), call for detailed and mechanistic understanding of the regulation of species distributions and biodiversity in relation to the dynamic interactions of water flow, erosion and sedimentation.

We present the results of a series of innovative hydromorphological stream restoration measures in The Netherlands, aimed at re-constructing the naturally dynamic and heterogeneous stream-riparian gradient of lowland sandy-substrate streams. These measures include re-meandering, channel excavation, narrowing of the stream profile and re-creation of a v-shaped stream valley with gently sloping riparian zones (Stowa watermozaïek 2011). We evaluate the achievements following these restoration measures in terms of stream and riparian vegetation rehabilitation and plant diversity and report on the mechanisms that contributed to successes (Fraaije et al. 2015). More specifically, we evaluate whether restoration of stream hydromorphology is sufficient, considering other abiotic limitations (water availability and water and soil quality, which are expected to greatly affect stream and riparian zone vegetation under ongoing global change; Garssen et al. 2014 & 2015) and biotic limitations (availability of nearby source populations to allow colonization of the restored sites, which has also been shown to be critical for restoration success; Brederveld et al. 2011).

Our results demonstrate how both abiotic limitations (environmental filtering) and biotic limitations (dispersal filtering) contribute to the assembly of plant communities in restored stream and riparian habitats. This clearly suggests that optimal vegetation restoration is achieved when a narrow, meandering stream with a v-shaped stream valley with gently sloping riparian zones is restored, allowing for a range of flooding and disturbance levels and a broad hydrological gradient, at sites with sufficient connections to surrounding source populations of target species. Therefore, not only the local site

should be considered, but rather a landscape-scale approach should be adopted when planning stream restoration activities (Verhoeven et al. 2008).

References

- Brederveld RJ, Jaehnig SC, Lorenz AW, Brunzel S & Soons MB (2011) Dispersal as a limiting factor in the colonization of restored mountain streams by plants and macroinvertebrates. *Journal of Applied Ecology* 48: 1241-1250.
- Fraaije RGA, ter Braak CJF, Verduyn B, Breeman LBS, Verhoeven JTA & Soons MB (2015) Early plant recruitment stages set the template for the development of vegetation patterns along a hydrological gradient. *Functional Ecology* DOI: 10.1111/1365-2435.12441.
- Garssen AG, Baattrup-Pedersen A, Voeselek LACJ, Verhoeven JTA & Soons MB (2015) Riparian plant community responses to increased flooding: a meta-analysis. *Global Change Biology* DOI: 10.1111/gcb.12921.
- Garssen AG, Verhoeven JTA & Soons MB (2014) Effects of climate-induced increases in summer drought on riparian plant species: a meta-analysis. *Freshwater Biology* 59: 1052-1063.
- Jähnig SC, Brabec K, Buffagni A, Erba S, Lorenz AW, Ofenbock T et al. (2010) A comparative analysis of restoration measures and their effects on hydromorphology and benthic invertebrates in 26 central and southern European rivers. *Journal of Applied Ecology* 47: 671–680.
- Naiman RJ & Décamps H (1997) The ecology of interfaces: riparian zones. *Annual Review of Ecology and Systematics* 28: 621–658.
- Stowa watermozaïek (2011) Beekdalbreed hermeanderen: maximaal ecologisch rendement.
- Verdonschot PFM & Nijboer RC (2002) Towards a decision support system for stream restoration in the Netherlands: an overview of restoration projects and future needs. *Hydrobiologia* 478: 131–148.
- Verhoeven JTA, Soons MB, Janssen R & Omtzigt N (2008) An Operational Landscape Unit approach for identifying key landscape connections in wetland restoration. *Journal of Applied Ecology* 45: 1496-1503.

EVALUATION OF RESTORATION SUCCESS IN THE DANUBE DELTA USING FISH ASSEMBLAGES

Nastase A & Staras M

AUREL NASTASE & MIRCEA STARAS

Danube Delta National Institute for Research and Development (DDNIRD), Babadag Street, No. 165, Tulcea (Romania)

Abstract

From total surface of Danube Delta Biosphere Reserve about 580,000 hectares almost 103,000 hectares was dammed affecting fish fauna in sense decreasing stocks, but in last 25 years was restored more than 15,025 hectares. To assess the restoration success, in this paper was compared natural and reconstruction areas in Danube Delta in period years 1997-2013 analysed for 2 representative group-comparative zones along the same longitudinal parallel. Results of restoration success using fish biodiversity metrics show an overlapping more than 60 %, some few exceptions, means medium to small difference between near natural lakes and restoration areas in Danube Delta.

Introduction

The Danube River is the second largest European river and world's most international river basin with a length of 2,857 km and a catchment size of 801,463 km². It includes the territories of 19 countries and is home to 83 million people. At its end, the Danube Delta is located on the coast of the Black Sea and includes the area between its three arms located in Romania and the secondary delta of Chilia arm, which is Ukrainian territory.

According to the 1st management Plan at the Danube river basin scale, 95 wetlands/floodplains (covering 612,745 ha) with the potential to be re-connected to the Danube River and its tributaries were identified in 2009. Of this, the Joint Program of Measures (JPM) indicated that 11 wetlands/floodplains (62,300 ha) should be reconnected by 2015 (www.ecrr.org).

Many rehabilitation projects in the large river-floodplain systems by the end of the 20th century were planned or achieved without prior knowledge of their potential for success or failure even they benefit from a consideration of river ecosystem concepts (Buijse et al., 2002). The existing guidelines have been developed mainly after 2000 and mostly for restoration of the longitudinal connectivity (www.ecrr.org).

Out of 8 implemented restoration projects in the Lower Danube, 6 projects have been implemented in the Romanian Danube Delta between 1994-2009 (Figure 1) and 2 projects upstream, in Bulgaria, implemented in 2008. Two type of measures were applied: wetland restoration and wetland reconnection with river in the case of polders used for agriculture and wetland reconnection with river in the case of polders used for fish farming.

The methodological approach evolved from empirical-experimental in the case of the large first floodplain restoration projects Babina and Cernofca implemented in 1994-1996 to a more process-based approach in the case of Holbina project, fully implemented by 2009.

This project had as specific objective to protect and maintain populations of species and habitats with mesotrophic character with high ecological values (Baboianu & Goriup, 1995; Drost et al., 1996; Drost et al., 2002). This objective was achieved by means of increasing the residence time.

So named, meanders project" is a smaller component of the restoration programme in the Danube Delta, with it was implemented in 2004-2005 to reconnect some isolated „islands" resulted from cutting the meanders for navigation purposes. They are inundated in the years and seasons with high water level only, and used by cyprinids fish species for spawning.

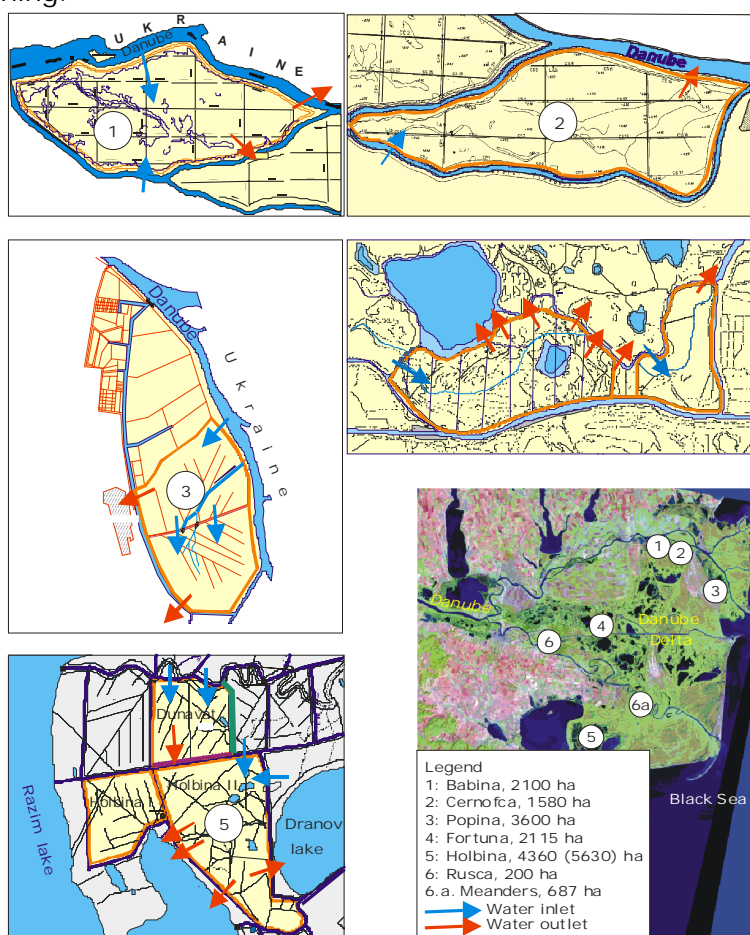

Figure 1 Implemented restoration projects in the Danube Delta

Material and methods

Historical situation of Danube Delta it's known 3 periods time: pristine status-building polders and channels period–wetland restoration period (Figure 2).

Out of 6 implemented restoration projects in the Danube Delta, the most part of available data sets are from Babina and Holbina-Dunavat projects (1997-2013), which have been analysed in comparison with near natural area at the same longitudinal parallel (Matita

and Babina lakes from Matita-Merhei complex respectively Iacub, Puiulet, Puiu, Rosu, Rosulet lakes from Rosu-Puiu complex), using two complementary methods of fish sampling (electric fishing for border zone and multimesh gillnets for deeper water identifying in Figure 3).

The similarity indexes (Sorensen, 1957) have been calculated to assess species composition resemblance between BQE samples from implemented restoration projects (RES) and natural/reference lakes (REF). Bray-Curtis (1957) similarity index has been calculated where reliable data on abundance was available (ex. fish). The available monitoring data set have been processed by PRIMER software.

The range of variation of similarity index between natural (reference) and restored areas (REF-RES) is large but in general within the limits of variation within and between natural lakes in the Danube Delta (REF-REF).

In addition to similarity qualitative index, Cohen's d (1988) quantitative index of differences between average values of biodiversity metrics (number of species, Shannon-Wiener, Evenness) for BQE in restored areas (RES) and natural reference floodplain lakes (REF).

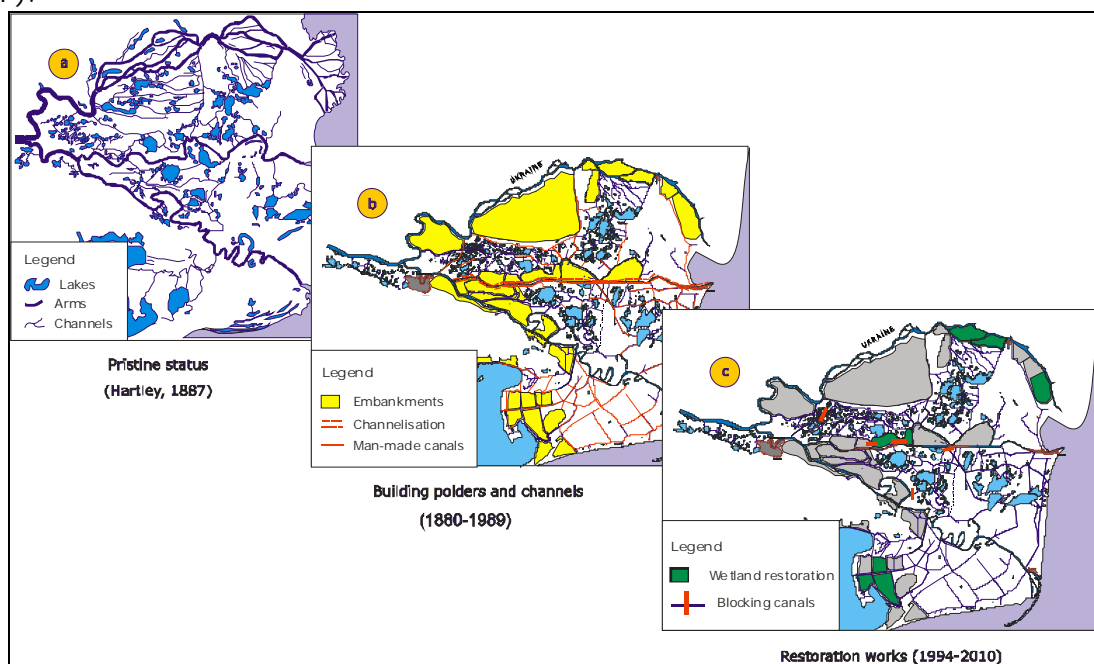

Figure 2 Phases in the recent Danube Delta history

Results

The highest similarity (60%-90%) between species compositions has resulted by comparing species composition of aggregated samples between reference and restoration areas, as expected (Ex. Ba*, H-D*). The large variation of the similarity index is due to the large variability of abiotic conditions between floodplain lakes or between sampling sites within reference lakes in the Danube Delta (Oosterberg et al., 2000; Coops et al., 2008).

The 95% confidence intervals for 35 electric fishing sites and 131 multimesh sites in samples have been used for interpretation. If the 95% confidence interval includes zero,

the difference is not significant (the null hypothesis can not be rejected) (Table 1). The results revealed that the differences between the metrics values in the restoration and natural/reference areas are not significant.

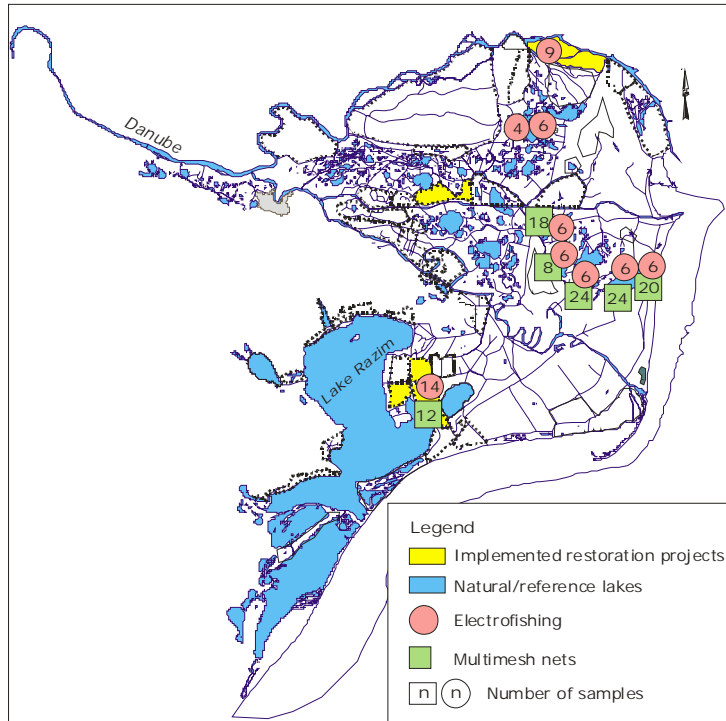

Figure 3 Fish monitoring location. Numbers indicate number of samples

Table 1 Standardized difference index between diversity metrics (Cohen's index „d")

Restoration projects (RES)	No. of samples (years)	Reference lakes (REF)	No. of samples (years)	BQE	Me-trics	d	d 95% upper	d 95% lower	Over-lap %
Ba	9 (1997)	Ma, Ba	10 (2008-2011)	fish (e) electro	Nr. sp	-0.25	+0.72	-1.23	80
					H	-1.13	-0.08	-2.16	40
					E	-1.33	-0.26	-2.40	35
H-D	14 (2007-2010)	Ro, Pu	27 (2008-2011)	fish (e)	Nr. sp	-0.33	+0.34	-1.00	76
					H	-0.50	+0.17	-1.17	67
					E	-0.51	+0.16	-1.19	66
H-D	12 (2007-2010)	Ro, Pu	94 (2008-2011)	fish (nets)	Nr. sp	-0.44	+1.61	-1.05	70
					H	-0.63	-0.02	-1.23	61
					E	-0.33	+0.27	-0.94	75

Abbreviations:

Ba= Babina restoration project (45.424763° N; 29.411763° E)
 H-D=Holbina-Dunavat restoration project (44.893336° N; 29.122695° E)
 Pu, R, Ma, Ba= Puiu, Rosu, Matita, Babina lake= Natural/Reference lake name

BQE= biological quality elements

fish=fish; multimesh, electrofishing = fish sampling method;

Metrics:

Nr. sp. =number of species
 H=Shannon-Wiener diversity index
 E=evenness index

The fish monitoring provided relevant data for floodplain reactivation. Fish diversity, abundance and biomass are strongly related with river connectivity, type of habitat and

fish migration for feeding or spawning. The published (Navodaru et al., 2008) and additional monitoring data on fish species composition and ecological guilds in Babina-Cernofca area before (1963) and after restoration works (1994-1996) are indicators for restoration of the lateral connectivity and ecological functions of the floodplain lakes as habitat for spawning, nursing and growing.

The presence of adults of reophilic species *Aspius aspius*, *Leuciscus idus* and larvae of migratory *Alosa tanaica* (Habitat Directive, Annex II) in Babina indicates that this area is used by these species for feeding or spawning.

Umbra krameri (Bern convention, Annex II) was found for the first time in autumn 2013, following stabilizing habitats with lentic characters.

The numerical abundance of fish fauna by size groups in 1997, after 3 years of restoration indicates the area is actively used for all life stages development.

The evolution of the fish species composition in Holbina-Dunavat restoration area shows a slight trend of decreasing the number of euritopic sp. as *Cyprinus c.*, *Sander l.* in favour of limnophilic such as *Petroleuciscus borysthenicus*, *Lepomis gibbosus*, *Carassius carassius*, *Umbra krameri*. This could be explained by increasing the residence time and high transparency area following implemented measures since 2000-2001. The monitoring of fish fauna during implementation of restoration project in Holbina-Dunavat area revealed dominance of euritopic species in the areas of water inlets and of limnophilic species in the opposite sites. The presence of young and adults rheophilic *Aspius aspius* (Habitat Directive, Annex II) in Holbina-Dunavat area indicates also a connectivity gradient with river.

Conclusion and recommendation

The restoration programme in the Danube Delta in the first stage, between 1991-2000, had as objective the restoration of aquatic habitats for flora and fauna including fish, damaged by embankments, according to its status as Biosphere Reserve since 1991, and its management plan. This objective became synergetic with those derived from Water Framework Directive and Natura 2000 network after 2000.

In the Danube delta two projects namely Babina and Holbina have been monitored intensively with positive response of biota to the restoration measures, including fish populations within there are not significantly differences using fish assemblages between restoration and near natural areas.

Presence of migratory or reophilous fish species in restoration areas confirm the restoring connectivity with river, but species occurrence from Habitat Directive, Bern convention confirm the success of ecological reconstruction.

Water quality in the Danube could be still a limiting factor for restoration success, with effects on fish populations, even has improved during the last decade, including nutrient content, but further improvement is still needed.

References

Banarescu, P. (1964). Pisces-Osteichthyes. Ed. Acad. Romane, Vol. XIII: 962.

- Bray, R.J., Curtis J.T. (1957). An ordination of the upland forest communities of southern Wisconsin. *Ecol Monogr*, 27: 325–349.
- Buijse, A.D., Coops, H., Staras, M., Jans, L.H., Van Geest, G.J., Grift, R.E., Ibelings, B.W., Oosterberg, W., Roozen, F.C.J.M. (2002). Restoration strategies for river floodplains along large lowland rivers in Europe. *Freshwater Biology*, 47: 889-907.
- Cohen, J. (1988). *Statistical power analysis for the behavioral sciences* (2nd ed.). Hillsdale, NJ: Erlbaum.
- Navodaru, I., Staras, M., Cernisencu I. (2008). Evolution of the ihtiofauna-Results of sampling and monitoring. In: *Evolution of Babina polder after restoration works* (Eds. Schneider, E., Tudor, M. & Staras, M.), WWF Auen Institute, Germany / Danube Delta National Institute, Romania. ISBN:978-3-00-025585-4: 42-46.
- Sørensen, T. (1957). A method of establishing groups of equal amplitude in [plant sociology](#) based on similarity of species and its application to analyses of the vegetation on Danish commons. [Kongelige Danske Videnskabernes Selskab](#), 5 (4): 1–34.

7. HOW TO IMPROVE THE (COST-) EFFECTIVENESS OF RIVER REHABILITATION?

The ELMO toolbox: Ecological modelling for decision support in river restoration planning

Bennetsen E et al.

ELINA BENNETSEN, SACHA GOBEYN, PIETERJAN VERHELST & PETER GOETHALS

*Laboratory of Environmental Toxicology and Aquatic Ecology, Ghent University, Jozef Plateastraat 22,
Ghent, B-9000, Belgium*

River managers are faced with the challenge of implementing appropriate actions to achieve a good ecological status of rivers. In light of this, it is important to understand which pressures should be addressed first. In this study an ecological toolbox ELMO is developed, which allows river managers to identify the most important stressors for a water body and to assess the ecological effects of management scenarios. The core of ELMO exists of a set of univariate habitat suitability models for frequently occurring taxa in three major aquatic biological groups (fish, macroinvertebrates and macrophytes). These models consider both physico-chemical and hydromorphological conditions. They have been developed by integrating ecological theory, expert knowledge and data analysis. The toolbox contains both an explanatory and a predictive mode. In the explanatory mode, ELMO evaluates the existing biological community against a defined reference condition. The most critical stressors can thus be identified by calculating the current habitat suitability for missing reference taxa. In the predictive mode, ELMO can calculate the community composition and the resulting ecological quality ratio under different management scenarios. The community composition under novel conditions is simulated by combining the habitat suitability models as hierarchical environmental filters. By considering species source pools in the current and past condition the predicted species distribution and the related ecological quality ratio can be derived. The combination of the explanatory and the predictive modes provides a powerful toolbox for guiding cost-effective management and restoration of river systems under multiple pressures.

Introduction

River managers are faced with the challenge of implementing appropriate actions to achieve a good ecological status of rivers. Furthermore only limited budgets are available to meet this end. It is thus important to understand which stressors should be addressed first when planning river restoration. In light of this, several efforts have been made for the development of decision support tools for river basin managers. These tools range from conceptual models related to ecology (Feld et al. 2010) to complex process-based simulation models for the physical-chemical water quality (Cools et al. 2011). In the past modelling efforts have mainly been focused on physical chemical water quality. The introduction of the European Water Framework Directive (WFD) steered the efforts also towards the inclusion of ecological models in decision support. Several tools are already available, including habitat suitability models (Mouton et al. 2006), species distribution models (Domisch et al. 2013) and statistically developed models directly relating abiotic river conditions to the ecological quality ratio (Everaert et al. 2010). Often these past developments have focused on the ability to predict the effect of river restoration measures on the biological water quality and not specifically on an analysis of important

stressors (Van der Most et al. 2006). Ecological modelling efforts should also consider the effect of hydromorphological improvements on the ecological status, as indicated by the WFD. In Flanders the hydromorphological monitoring has only been developed since the introduction of the WFD. Thus, hydromorphological data only has been available on a large scale since recently.

In this paper we discuss a new decision support toolbox that has been developed in cooperation with the Flemish Environment Agency. The toolbox integrates species distribution models for fish, macroinvertebrates and macrophytes into a decision support system for river management in Flanders. It not only allows the evaluation of new scenarios, but also the identification of the critical stressors in a water body. Possible stressors include both physical-chemical variables as hydromorphological variables. In the following paragraph we will discuss the layout of the toolbox and its development.

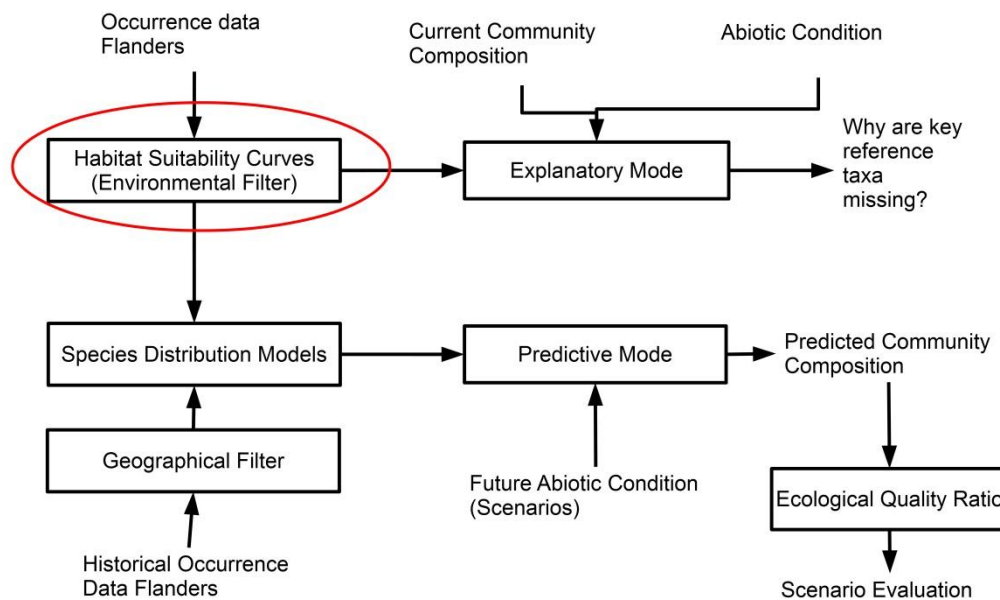

Figure 1: General layout of ELMO. The core exists of a set of Habitat Suitability Curves.

The ELMO toolbox: General methodology

The core of ELMO exists of a set of habitat suitability curves. These are integrated in a decision support system that can operate in two modes (Figure 1). In the explanatory mode the current ecological condition of the river is evaluated against a defined reference condition. Based on this, missing reference taxa can be identified. The calculation of habitat suitability for these taxa allows the identification of the most crucial factors for river restoration. Based on the outcome of the explanatory mode or other water quality models, scenarios can be designed. The effect of these scenarios can then be evaluated with the predictive mode of the toolbox. In the predictive mode, the habitat suitability curves are combined in a species distribution model similar to the Spatially Explicit Species Assemblage Modelling (SESAM) framework presented by Guisan and

Rahbek (2011). This mode predicts the distribution of relevant species to the water body. The aim is to create a simulated biological sample, allowing to calculate the ecological quality ratio directly from this predicted community. In the following paragraphs the development of the individual elements of ELMO are elaborated upon.

Development of the toolbox

Development of Habitat Suitability Curves

The core of ELMO exists of a set of univariate habitat suitability curves. These curves have been developed based on a combination of Flemish data and knowledge. The curves describe the range of individual variables at which a certain species has been detected. The curves have a trapezoid shape. The data driven development of the curves is based on the assumption that species show a unimodal response to environmental gradients (Austin 2007). Thus we derived trapezoid curves from the species distribution along an environmental gradient. In Figure 2, the boxplot for variable Y is derived from the data points at which species X has been observed. The parameters (i.e. a_1 , a_2 , a_3 and a_4) for defining the trapezoid curve are derived from the parameters of the boxplot.

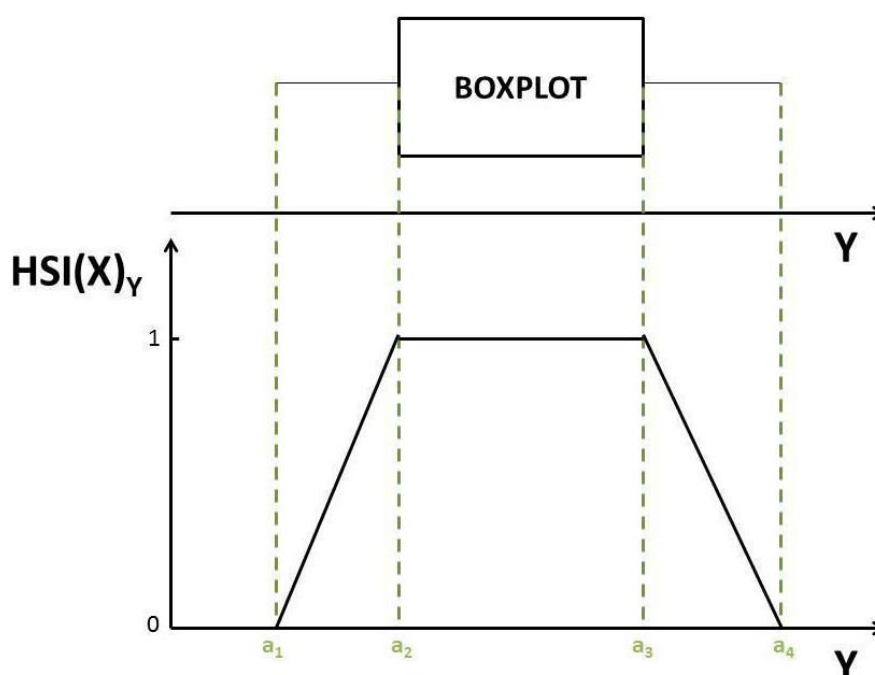

Figure 2: Data driven derivation of habitat suitability curves (HSI) for variable Y and species X. The trapezoid is defined by parameters a_1 , a_2 , a_3 and a_4 .

The knowledge based development and validation of the habitat suitability curves was performed by comparing the curves based on Flemish data to curves based on similar boxplots from the Netherlands (Knoben and Peeters 1997, Stowa 2007). Since both sources for the models encompass similar environments (lowland rivers), the base premise was that robust models should describe similar ranges. Based on this premise, we developed a scoring system that allows to evaluate the overlap between the Flemish and the Dutch curves. Seven cases were defined and for each case specific actions and levels of confidence were defined. For example, if both sets would describe similar ranges, we would give the model a high level of confidence. When the Flemish data

would be much narrower compared to the Dutch model, the model would get a lower level of confidence and would be adapted based on the Dutch curves.

Explanatory mode

The explanatory mode follows the logic of the RIVPACS approach (Clarke et al. 2003). The biological condition is evaluated against the reference community for the water body type. The reference community for a water body type is defined by a list of reference taxa used in the WFD implementation in Flanders. Each reference taxon is also linked to a species group, which consists of taxa that are assumed to be interchangeable. This means that they have similar ecological preferences and compete directly for similar habitats. Thus they represent ecological aliases of each reference taxon. These species groups have been constructed based on ecological preferences, biological traits and expert validation. When evaluating the biological condition, both taxa on the reference list and their aliases are considered. If either the taxon itself or one of its aliases is found in the sample, it is not indicated as missing. The next step is to calculate the habitat suitability for each missing taxon based on the current physical-chemical and hydromorphological condition. This results in a ranking of all variables according to how limiting they are for achieving the reference condition in the water body.

Predictive mode

In the predictive mode, a scenario can be evaluated in terms of its effect on the community composition and the ecological status. By combining the individual habitat suitability curves as hierarchical environmental filters, the potential community composition under the scenario can be calculated. The actual community composition per year is calculated by considering a geographical filter combined with the habitat suitability, similar to the SESAM approach (Guisan and Rahbek, 2011). This geographical filter considers the species distribution in the previous years in nearby water bodies. This means that although the habitat suitability for a species might be high, ELMO will not consider the species as present if it was not yet found, nor predicted in any nearby water bodies in the past years. This model structure has been validated using cross-validation for each species and by calculating Cohen's Kappa for each species distribution model. For fish and macroinvertebrates at least 25% of the models had a good score for Kappa (Kuhn, 2013, $K > 0.3$) and more than half of the models scored at least a Kappa of 0.25. For macrophytes the approach resulted in a lower accuracy and the addition of a geographical filter had no added value.

The output of these species distribution models is the presence-absence for each considered species. To calculate the ecological quality ratio from this simulated sample directly, other information is also required such as the abundance of a species. To realize this it is necessary to make assumptions about the parameters in the ecological quality ratios. Considering the low quality of the macrophyte models, this module was only developed for fish and macroinvertebrates.

To validate these assumptions sensitivity analyses were performed on each ecological index used in the toolbox. This allowed to quantify the effect of the uncertainty of certain parameters on the value of the ecological index. The maximal error of classification was 20%, which is low considering the 5 classes in the ecological quality ratios. The quality of the complete modelling pathway was validated against an independent dataset. For

macroinvertebrates this approach resulted in 32% of the samples being classified correctly, based on the ecological quality classes, but the introduced error was consistently caused by overprediction by one class. For fish 50% of the samples were classified correctly, but the introduced error was not clearly related to under- or overprediction. This difference could be explained by the fact that the ecological index for macroinvertebrates, the MultiMetric Index Flanders (MMIF, Gabriëls et al 2010) requires less assumptions to be made compared to the Fish Index (Belpaire et al. 2000, Breine et al. 2004) which consists of many different submetrics.

Outlook

The general philosophy behind this toolbox is to allow a continuous improvement of the models through new ecological insights and data. The construction of the toolbox allows the integration of new models and new theories in a flexible manner. In this research we have developed the first version of the implementation and identified the issues inherent to the approach. We have found the method to be suitable for fish and macroinvertebrates, but not for macrophytes. Data were scarce for macrophytes though, so this might be the first source of error. Furthermore the current implementation of the geographical filter doesn't work well for macrophytes. The explanatory part of the toolbox has been fully validated, but the predictive mode needs some further improvement before it can be applied. There is a general trend of overprediction for the species distribution. To solve this additional filters can be included in the model. This could for example be the introduction of biotic interactions or the refinement of the geographical filter. Fixing this issue for macroinvertebrates will probably result in a full-fledged toolbox for this biological group. With regard to fish also the assumptions made related to the fish index need to be recalibrated, before the toolbox will be fully functional.

These results show that ELMO can be used to support the development of river restoration plans, certainly towards the identification of important stressors. In the future the model can systematically be improved by the introduction of new data and knowledge.

Acknowledgements

The authors would like to thank the Flemish Environment Agency who commissioned the study on which this presentation was based.

References

- Austin, M. (2007), Species distribution models and ecological theory: A critical assessment and some possible new approaches. *Ecological Modelling*, 200, 1-19.
- Belpaire, C., Smolders, R et al. (2000), An Index of Biotic Integrity characterizing fish populations and the ecological quality of Flandrian water bodies. *Hydrobiologia* (434), 17 -33.
- Breine, J., Simoens, I. et al. (2004), A fish-based index of biotic integrity for upstream brooks in Flanders (Belgium). *Hydrobiologia* (522), 133 – 148.
- Clarke, R.T., Wright J.F et al. (2003) RIVPACS models for predicting the expected macroinvertebrate fauna and assessing the ecological quality of rivers. *Ecological Modelling* 160(3), 219-233.
- Cools, J., Broekx S. et al. (2011). Coupling a hydrological water quality model and an economic optimization model to set up a cost-effective emission reduction scenario for nitrogen. *Environmental Modelling & Software* 26(1), 44-51.
- Domisch, S., Kuemmerlen M. et al. (2013). Choice of study area and predictors affect habitat suitability projections, but not the performance of species distribution models of stream biota. *Ecological Modelling* 257, 1-10.

- Everaert, G., Pauwels I. et al. (2010). Development of data-driven models for the assessment of macroinvertebrates in rivers in Flanders. 5th Biennial meeting of the International Congress on Environmental Modelling and Software (iEMSs 2010): Modelling for environment's sake. Vol. 3. International Environmental Modelling and Software Society (iEMSs).
- Feld C.K., Birk S. et al. (2010). Deliverable D5. 1-1: Conceptual Models and effects of river rehabilitation and restoration measures on aquatic organisms. Report of the WISER project
- Gabriels, W., Lock, K. et al. (2010), Multimetric Macroinvertebrate Index Flanders (MMIF) for biological assessment of rivers and lakes in Flanders (Belgium). *Limnologica*, 40, 199–207.
- Guisan, A., Rahbek, C. (2011). SESAM - a new framework integrating macroecological and species distribution models for predicting spatio-temporal patterns of species assemblages. *Journal of Biogeography*, 38(8), 1433–1444.
- Knoben, R. A. E. and Peeters, E. T. H. M. (1997) Eco-atlas van waterorganismen, deel I-V. Stowa rapport 97-39
- Kuhn M., (2013), Applied Predictive Modelling. Springer Science & Business Media, New York, 574 pp.
- Mouton, A., De Baets B. et al. (2009). Knowledge-based versus data-driven fuzzy habitat suitability models for river management. *Environmental Modelling & Software* 24(8), 982-993.
- Stowa (2007), Responsecurves, through www.limnodata.nl (last visited 9/3/2013)
- Van Der Most, H., Jeuken A. et al. (2006). WFD-Explorer Q4: A planning kit to support the implementation of the Water Framework Directive. The 7th International Conference in Hydroinformatics, Nice, France.

Restoration success and failure: learning from an integrated restoration programme in a temporary Mediterranean river system

Cortes R. M. V. et al.

RUI M. V. CORTES¹, SAMANTHA J. HUGHES¹, ISABEL BOAVIDA², JOÃO OLIVEIRA³, JOAQUIM B. JESUS¹, PAULO ALMEIDA¹ & SIMONE G.P. VARANDAS¹

¹Centre for Research and Technology of Agro-environmental and Biological Sciences (CITAB), UTAD, Quinta de Prados, 5000-911 Vila Real, Portugal

²Instituto Superior Técnico, Universidade Técnica de Lisboa, Av. Rovisco Pais, 1049-001 Lisbon, Portugal

³Centre of Forest Studies, Instituto Superior de Agronomia, Universidade Técnica de Lisboa 1349-017 Lisbon, Portugal

Located in a sensitive Natura 2000 protected area, the construction of the River Odelouca dam in the Algarve region of southern Portugal was subject to diverse compensation measures, including environmental requalification of selected river segments. We cover the whole sequence of the project: a) characterization and selection of reaches to rehabilitate based on the definition of physiographic units and the relative quantification of impacts; b) implementation of soil engineering techniques for improving riparian habitat, bank stability and to control invasive species c) defining best river channel habitat improvement options for endangered endemic fish populations; d) post-project appraisal and monitoring of floristic succession, fish, benthic fauna and habitat. The success of defined measures has been hampered by continued difficulty to control sources of environmental disturbance, in particular serious and constant point-source pollution from animal husbandry units situated in the catchment.

Introduction

There is increasing concern about ecological losses caused by stream degradation due to human activity. This problem assumes dramatic proportions in Mediterranean rivers because of the higher demand for limited freshwater supply due to highly variable hydrological patterns. Drought is a common phenomenon that disrupts fluvial connectivity, habitat availability and complexity. These factors have direct and indirect impacts on the resident biota. Further, flash floods can disrupt river channel configuration. A rehabilitation program was undertaken in a segment of R. Odelouca, impacted by intensive permanent agriculture crops and, more recently, the construction of a highly contested water supply dam. The R. Odelouca runs through a Natura 2000 protected area and houses critically endangered endemic fish species, making habitat improvement compensatory measures strictly necessary.

Study Area

The R. Odelouca (catchment area 520 km², 83 km length) drains from an altitude of 509 m and discharges at about sea level into the Arade estuary. The basin drains mainly schists and greywackes from the Carboniferous period. The climate is Mediterranean with oceanic influence, comprising warm to hot, dry summers and cool, wet winters. Upstream reaches of the Odelouca have well-developed riparian galleries dominated by alders *Alnus*

glutinosa, willows *Salix* spp. and ashes *Fraxinus angustifolia*. The study segment situated below the dam suffers from collapsing and subsiding banks due to fluvial erosion and agricultural activities in extensive citrus groves. These conditions favor the establishment and spread of dense stands of the invasive giant-reed *Arundo donax* finds, despite the fact that Mediterranean sclerophyllous, evergreen scrub and cork oaks still form a characteristic part of the landscape. Fish assemblages include a pool of native species, including two endangered cyprinids *Iberochondrostoma almakai* and chub *Squalius aradensis*. Other native species include the loach (*Cobitis paludica*), eel *Anguilla* and *Barbus sclateri* occurs sparsely (Pires et al., 2010). Habitat degradation due to dam construction and poor water quality have allowed exotic and invasive fish species increase in number. These include the highly abundant mosquito fish *Gambusia holbrooki*, the pumpkinseed *Lepomis gibbosus*, the largemouth bass *Micropterus salmoides*, chameleon cichlid *Australoheros facetus*, carp *Cyprinus carpio*, and straight-mouth nase *Pseudochondrostoma polylepis*. The American crayfish has also extended its range following the construction of the artificial reservoir.

Material and Methods

A detailed appraisal of the entire catchment was carried out by using different abiotic data layers such as geology, climate and soil cover to define distinct physiographic units. Other data layers containing descriptors of disturbance (habitat modification, roads, point and non-point pollution) allowed us to define physiographic units where rehabilitation should take place as well as the most suitable types of measures. Measures were designed to prevent over widening of the river channel in the most critical reaches. Following bank reprofiling, we used soil engineering techniques such as vegetated gabions, rip-rap and a cribwall to stabilize the banks. Areas with invasive cane were clear cut, treated with a double-matt (organic and synthetic) of bio-degradable geotextile and replanted with riparian trees and shrubs to improve bank stability and control the advance of the invasive giant-reed. Replanting was carried out using stock derived and grown in a plant nursery on from cuttings and seeds collected in the area of the reservoir before flooding. This measure ensured genetic provenance and control of planted trees (mainly ash trees and willows) and shrubs (such as *Tamaryx* and *Oleander* spp.) which followed observed longitudinal succession mapped in previous surveys.

This study applied 2-D hydraulic simulations to evaluate the efficacy of habitat improvement measures for the two endangered cyprinid species in a modified reach of the Odelouca. The following instream structure configurations were assessed: i) placement of three islands in the middle of the river channel; ii) introduction of two lateral bays on opposite banks; iii) introduction of four alternate current deflectors. Though the use of such instream structures has been considered in many habitat improvement projects (e.g. Garcia de Jalón and Gortázar, 2007), no previous analysis of their potential effectiveness on fish habitats has been carried out in non-salmonid rivers. Our findings are extremely relevant for assessing measures in other Mediterranean-type rivers, where the implementation of instream structures and compensatory measures as a means of recovering other threatened fish populations has been questioned. The River2D model (Steffler, 2000) was used with this purpose: This finite element model simulates hydraulic conditions from topographic data input and uses the habitat suitability index curves containing known fish biological preference data to calculate the potential habitat for specific life-history stages by the Weighted Usable Area (WUA). The

model was applied to a 250 m representative reach. Habitat suitability curves (HSC) of depth, velocity and substrate were previously developed for specific fish size-classes according to differences in length and age structure (Santos and Ferreira, 2008): < 5, 5-7 and >7 cm for nase and < 4, 4-6, > 6 cm for chub roughly corresponding to the fish life-history stages of young-of year (yoy, 0+), juveniles (1+), and adults (>1+), respectively.

The habitat improvement measures were concluded in the field in late spring 2012. Monitoring programs were carried out from 2011-2014 to assess the success of the measures. Monitoring covered the succession of floristic communities in the river corridor as well aquatic surveys of benthic macroinvertebrate communities, fish community and river habitat quality. All sites were electrofished (DC, 300–700 V) during late spring–early summer base flow. In this period stream flows were diminishing but there was still full connectivity between habitats, thus ensuring a higher fishing efficiency (Oliveira et al., 2012). To compare changes in fish communities and to evaluate the ecological quality of sample sites we used the fish-based index of biotic integrity for Portuguese wadeable streams (F-IBIP) (INAG and AFN, 2012).

Results and Discussion

The model 2-D hydraulic simulations allowed us to compare the effect of placing different instream structures in a physically modified river reach on the habitat preference of two critically endangered fish species. The best simulated scenario (Table 1) was the placement of islands in the river channel (Fig. 1). This scenario was found to be the most suitable to enhance habitat of both species life-history stages, in particular of young-of-year and juveniles.

These findings highlight the need to consider the use of different life-history stages, when modelling habitat improvement for conservation of endangered fish populations. The implementation of such structures should be considered not only in the context of for the present study, but also as a starting point and sound basis for further habitat improvement studies in Mediterranean rivers that house other similarly threatened "sister" species.

Table 1. WUA improvement (%) for the three scenarios and for the different discharges ($\text{m}^3 \text{s}^{-1}$).

Discharge	Islands			Lateral bays			Deflectors		
	YOY	Juv.	Adult	YOY	Juv.	Adult	YOY	Juv.	Adult
1	126.7	78.1	46.9	8.2	3.9	2.2	-7.7	-16.7	-24.8
2	145.9	96.7	71.9	21.3	11.6	4.9	-3.1	-18.2	-26.7
4	155.4	91.1	96.5	46.6	25.9	10.8	-9.9	-33.9	-22.4
6	98.1	78.2	88.6	59.8	41.4	14.9	2.7	-17.7	-11.2
8	100.9	78.1	79.9	91.6	65.9	19.9	5.2	-6.2	-7.6

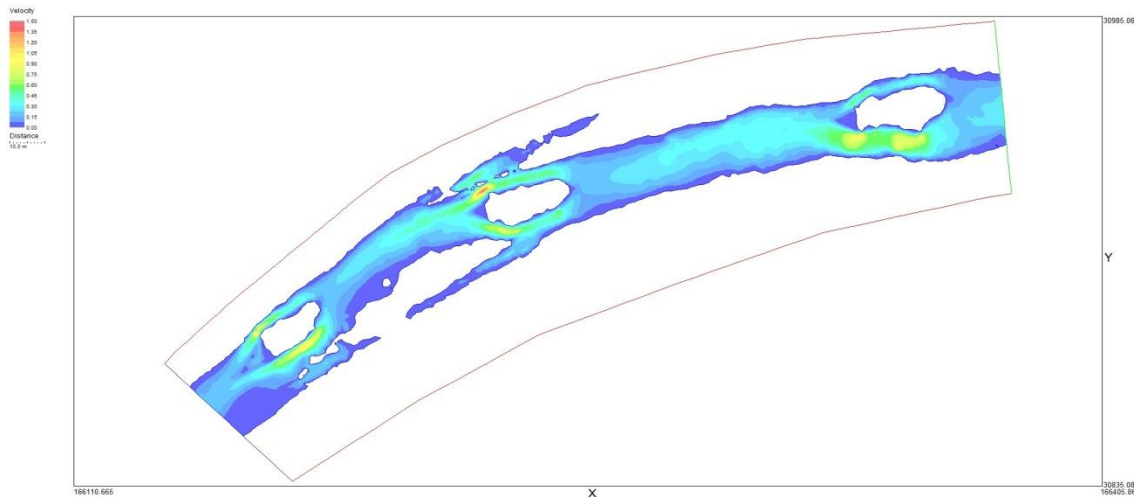

Figure 1. Velocity flow fields simulated with the River2D for the selected scenario of islands in the mid-section of the channel.

A total of collected 11 species of fish represented by 4521 individuals (seven native, three exotic and one translocated taxa) were collected over a two year period. In both years fish communities were clearly dominated by three species (*A. anguilla*, *C. paludica* and *G. holbrooki*) representing over 70% of the total catch. Native cyprinids populations represented only a small fraction of these communities, although they were present in all 2011 sites (prior to rehabilitation measures). However, these species were absent from the most degraded stream reaches of our study in the following year.

Abundance levels of alien species varied considerably between segments and years, but generally represented a relevant proportion (> 25%) of the total species composition. Results also seem to indicate increasing dispersal of the translocated species *P. polylepis*, an endemic species from central Portugal, with the number of occurrences increasing from 2011 (one site) to 2012 (three sites) following intervention measures. Thus, all segments housed highly degraded fish communities, dominated by very tolerant species a significant presence of alien forms and a low proportion of native invertivores cyprinids and native lithophilics. Results of the F-IBIP calculation reflect these observations with all stream reaches presenting bad or poor biological quality in both years. The F-IBIP score was even lower in three of the assessed segments in the second year of sampling, decreasing from poor to bad.

Macroinvertebrate communities tended to show an increase in richness in the segments downstream of the dam in the second sampling year, with numbers similar to the reference site (Fig.2). The official WFD index classified 4 of the 5 sites as excellent. A Principal Components Analysis ordination plot of the successional evolution of the vegetation from phytosociological surveys in 39 plots, illustrates a gradual return of vegetation composition to the reference situation, which is notoriously more diverse (Figure 3).

In conclusion, we must out that the reduced recover was related to the continuation of the low water quality from point-discharges, in spite of the habitat improvement.

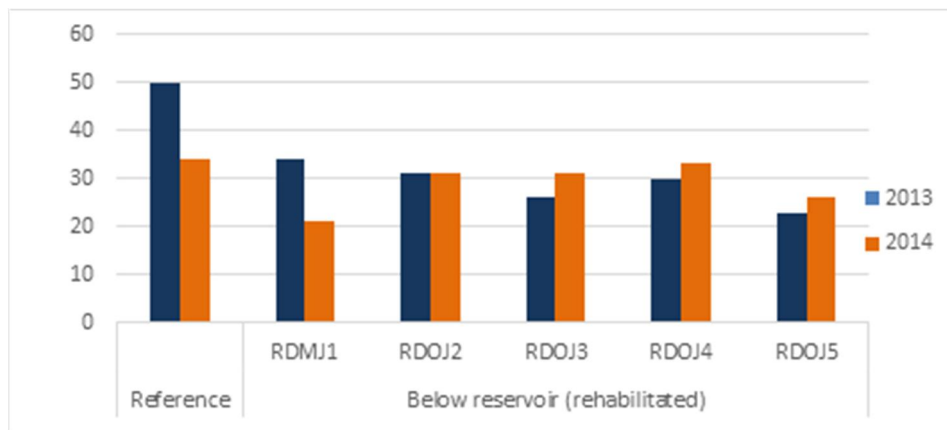

Figure 2. Invertebrate richness in the reference reach and in the 5 sites along the rehabilitated segment.

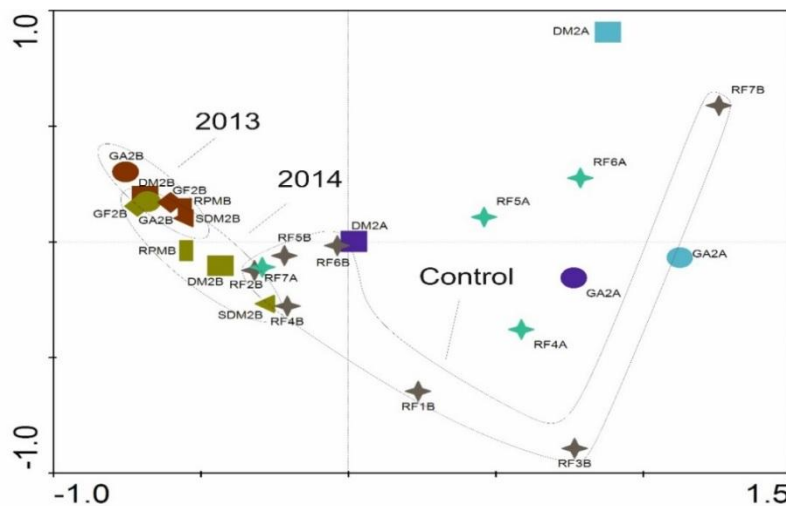

Figure 3. Principal Component Analysis representing the 39 plots obtained in the reference sites and in the surveys that took place in the 2 years after rehabilitation.

References

García de Jalón, D, Gortázar, J (2007). Evaluation of instream habitat enhancement options using fish habitat simulations: case-studies in the river Pas (Spain). *Aquat Ecol* 41: 461-474. DOI: 10.1007/s10452-006-9030-x.

INAG, AFN (2012). Desenvolvimento de um índice de qualidade para a fauna piscícola. Ministério da Agricultura, Mar, Ambiente e Ordenamento do Território, Lisbon.

Oliveira, JM, Segurado, P, Santos, JM, Teixeira, A, Ferreira, MT, Cortes, RV (2012). Modelling stream-fish functional traits in reference conditions: regional and local environmental correlates. *PLoS ONE* 7, e45787.

Pires, DF, Pires AM, Collares-Pereira, MJ, Magalhães, MF (2009). Variation in fish assemblages across dry-season pools in a Mediterranean stream: effects of pool morphology, physicochemical factors and spatial context. *Ecology of Freshwater Fish* 19: 74–86. DOI: 10.1111/j.1600-0633.2009.00391.x.

Santos, JM, Ferreira MT (2008). Microhabitat use by endangered Iberan cyprinid nase *Iberochondrostoma almakai* and chub *Squalius aradensis*. *Aquatic Sciences*, 70:272-281. DOI: 10.1007/s00027-008-8037-x.

Steffler, P (2000) Software River2D. Two Dimensional Depth Averaged Finite Element Hydrodynamic Model. University of Alberta, Canada.

Evaluating the environmental costs of flow regulation: a dynamic water pricing approach

Garcia De Jalon S et al.

SILVESTRE GARCÍA DE JALÓN¹, MARTA GONZÁLEZ DEL TÁNAGO², CARLOS ALONSO² & DIEGO GARCÍA DE JALÓN²

¹*Department of Forestry and Natural Resources, Purdue University, Indiana, USA*

²*ETS Ingeniería de Montes, Forestal y del Medio Natural, Universidad Politécnica de Madrid, 28040 Madrid, Spain*

Introduction

Economic analyses are gaining a key role in water policy, providing valuable information for developing sustainable management of water bodies. The European Water Framework Directive (WFD) (2000/60/EC) is the primer EU environmental legislation that explicitly requires economic analysis of water uses for both purposes (i) assessing the level of recovery of costs of water services and (ii) estimating the potential costs of restoration measures (Article 9. Annex III). Although many attempts have been made in formulating methods and applications of economic principles to achieve the environmental objectives of the WFD (WATECO, 2003; Babulo et al., 2011; Bithas et al., 2014), water users still do not pay the full cost recovery of water supply. Environmental costs are usually the first ones which are not fully recovered, partially due to the complexity of nonmarket valuation.

Flow regulation by dams and reservoirs is considered as one of the most frequent source of environmental impacts in rivers (Nilsson et al., 2005; Poff et al., 2007). Despite there being a multitude of approaches assessing environmental costs based on people's preference and production function (e.g. Hanley and Barbier, 2009) there is a lack of approaches assessing environmental costs proportionally to the impact produced by flow regulation. Our study aims to offer a new approach for assessing the environmental costs of flow regulation based on the intensity of the hydrological alteration of the natural flow regime. We propose a dynamic water pricing approach which is determined by the hydrologic alteration that the river suffers at every time instant (i.e. changes in river flow due to flow regulation).

Study sites

The proposed methodology has been applied in three European regulated rivers, the River Marna from Norway, the River Tyne from United Kingdom and the River Esla from Spain. The selected site in the River Marna is located in Laudal, Vest-Agder (Norway). The dam was built in 1981 and the reservoir has a capacity of 1.5 Hm³. Flow data range from 1958 to 2013. The studied site in the River Tyne is located in Kielder reservoir in Falstone, Northumberland (United Kingdom). The dam was built in 1981 and the reservoir has a capacity of 200 Hm³. Flow data correspond to the period 1957-2012. The studied site of the River Esla (Spain) corresponds to the Riaño reservoir, created in 1987 with a capacity of 664 Hm³. Flow data are available from 1965 to 2011.

Methodological procedure

The methodological approach developed in this paper aims to estimate the marginal environmental costs of flow regulation on the basis of the human-induced environmental impact. It can be applied to any regulated river reach in which pre-dam and post-dam flow data are available.

a) Admissible range of flow variability

The first step of the methodological process is to calculate the admissible reference range of flow variability to subsequently calculate the environmental impact due to flow regulation. Any variation of the daily flows within this range may be considered "admissible" and any variation out of the admissible range would be considered as an environmental impact. We define the reference admissible (i.e. acceptable values) area of flow variability as the range of values between the 10- and 90- percentiles of each daily flow within the years in which the river flow was not regulated. In order to smooth the curve of the upper and lower limits of this admissible range, a moving average with thirty lags (i.e. 30 days) is used (Figure 1).

b) Estimation of flow regulation impacts

The second step evaluates the environmental impact due to flow regulation of each river reach at any time instant. It calculates the impact as the divergence between the currently circulating flows and the reference area of admissible flow variability. Equations 1 and 2 show how *High-flow* and *Low-flow* impacts of a river reach i in a time instant t is proposed to be calculated. Both impacts are calculated as the distance from the high (90 percentile) and low (10 percentile) limits of admissible area of discharges.

$$\text{High flow Impact}_{i,t}(\text{units}) = \frac{\text{Current flow}_{i,t} - \text{High reference flow}_{i,t}}{\text{Current flow}_{i,t}} \quad (1)$$

$$\text{Low flow Impact}_{i,t}(\text{units}) = \frac{\text{Low reference flow}_{i,t} - \text{Current flow}_{i,t}}{\text{Low reference flow}_{i,t}} \quad (2)$$

Where *High reference flow* indicates the upper limit of the reference area of admissible flows (percentile 90 of the reference flow) and *Low reference flow* indicates the lower limit of the reference area (percentile 10 of the reference flow).

In order to consider in the assessment not only deviations in the magnitude and timing of water conditions but also the duration of the events, *High-flow* and *Low-flow* impacts were calculated for different time periods (i.e. moving averages of 3, 7, and 30 days). Figure 1 shows an example in Esla River of how the *High-flow* and *Low-flow* impacts are estimated as the distance from the reference admissible area. In this case, the river exhibited a peak flow in June which is by far higher than in any day in July and August. Nevertheless, despite the magnitude of the peak flow in June being higher than any day in July and August the *High-flow* impact in July and August is higher than in June. This is due to whilst the duration of the peak flow in June is rather short the high flow in July and August was very long and constant.

c) Estimation of marginal environmental costs of flow regulation

The last step is to set the marginal environmental costs of flow regulation which are calculated proportionally to the environmental impact of flow regulation. Thus the environmental cost in a time instant t (i.e. day) is calculated as the product of the

environmental impact of flow regulation in the previous time instant (i.e. $t-1$ or the day before) and the coefficient Ku which is measured in euros per cubic meter of regulated water, following Equation 3:

$$Environmental\ Costs_{i,t} \left(\frac{\text{€}}{\text{m}^3} \right) = Environmental\ Impact_{i,t-1} * Ku_{i,t-1} \left(\frac{\text{€}}{\text{m}^3} \right) \quad (3)$$

The coefficient Ku is used to transform environmental impact into environmental costs, which could be proportionally or exponentially, i.e. the costs increases exponentially as the environmental impact increases (Equation 4):

$$Ku_{i,t} \left(\frac{\text{€}}{\text{m}^3} \right) = a_{i,t} \left(\frac{\text{€}}{\text{m}^3} \right) * \exp^{b_{i,t} * Environmental\ Impact_{i,t}} \quad (4)$$

where a is a coefficient measured in euros per cubic meter that represents the cost of regulation rights. b is a coefficient that captures the vulnerability or conservation interest of the regulated river reach.

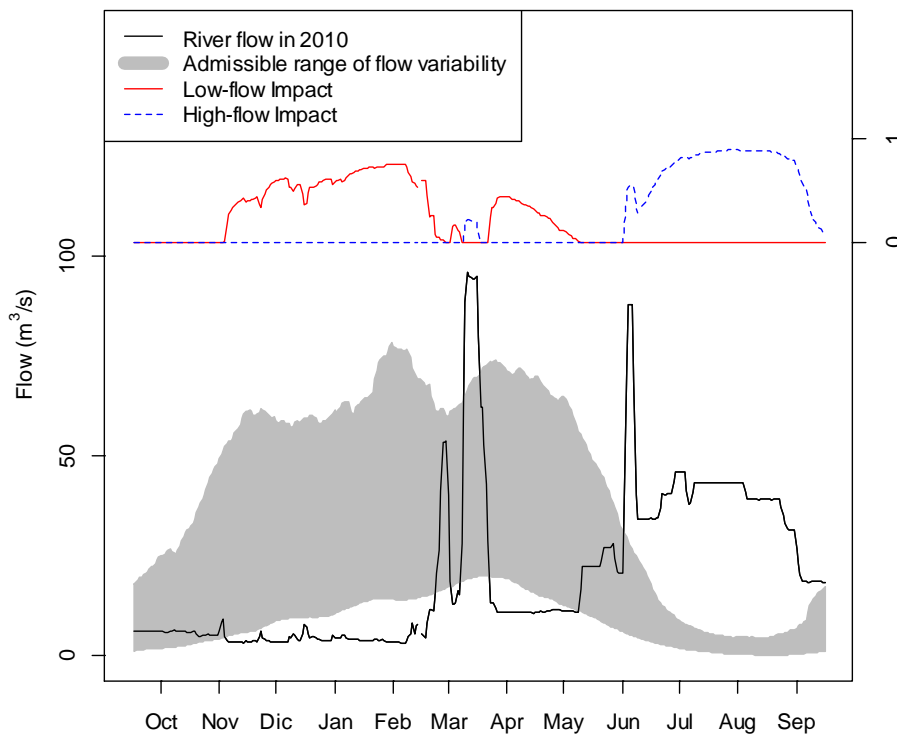

Figure 1. Example of the estimation of *Low-flow* and *High-flow* impacts of flow regulation in Esla River in 2010. The lower graph shows the estimated reference admissible range of flow variability (grey area) and the circulating discharge (black line). The upper graph shows the estimated *Low-flow* and *High-flow* impacts (red and blue curves respectively) calculated as the deviation from the admissible area.

Results

The first part of our results shows the admissible reference range of flow variability in North Tyne, Esla and Marna Rivers (Figure 2). Esla River presents the lowest discharges

and consequently the narrowest admissible range of flows. During summer, the river flow is notably low and can even dry up in an extremely dry year. This is reflected in the width of the admissible area which is considerably narrow in summer. Marna River presents the largest discharges and consequently the widest admissible reference area.

Whilst North Tyne River presents very low environmental impacts due to flow regulation Esla and Marna rivers seems to be very affected by the dam operation. Esla River suffers from elevated discharges during summer (high-flow impact) and from low discharges in winter (low-flow impact). This phenomenon is very common in Mediterranean rivers as the high discharges coincide with the irrigation seasons. In Marna River, the discharges downstream from the dam have been strongly lowered and occasionally the river has even dried up due to the generation of hydro electrical power. This has led to a dramatic hydrologic alteration due to discharges close to zero (low-flow impact).

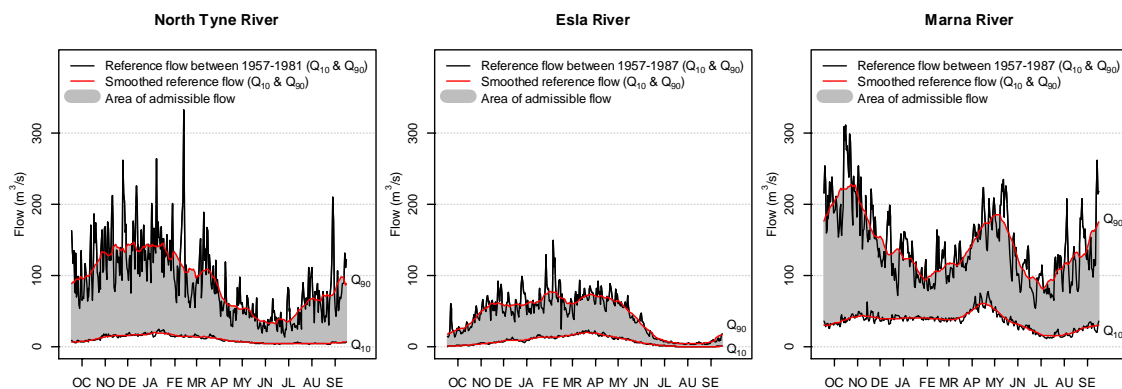

Figure 2.- Admissible range of flow variability of the case studies defined by the smoothed line (red line) of 10- and 90-percentiles of mean daily flows within the natural (i.e. non regulated) flow regime.

The final step of our approach assesses the environmental costs of flow regulation according to the environmental impact that the river suffers for each time instant, i.e. the environmental cost of a given time instant is proportional to the environmental impact in the previous time instant. Thus our approach is used as a dynamic indicator of the environmental cost that water users should pay for costs recovery of water. Figure 3 presents through a sensitivity analysis, the estimated environmental costs of flow regulation in 2010. It shows the fluctuation in environmental costs under different values of the coefficient a and b in Equation 4. In all scenarios Marna River presents the highest water environmental costs as it suffers the highest hydrologic alteration from high-flow impacts. In Esla River, from mid-November to February and from mid-June to late September environmental costs are notably high due to low-flow impact and high-flow impact respectively. In North Tyne River, environmental costs are very low in all scenarios except from some determined days when due to some extreme water conditions the environmental costs occasionally increased.

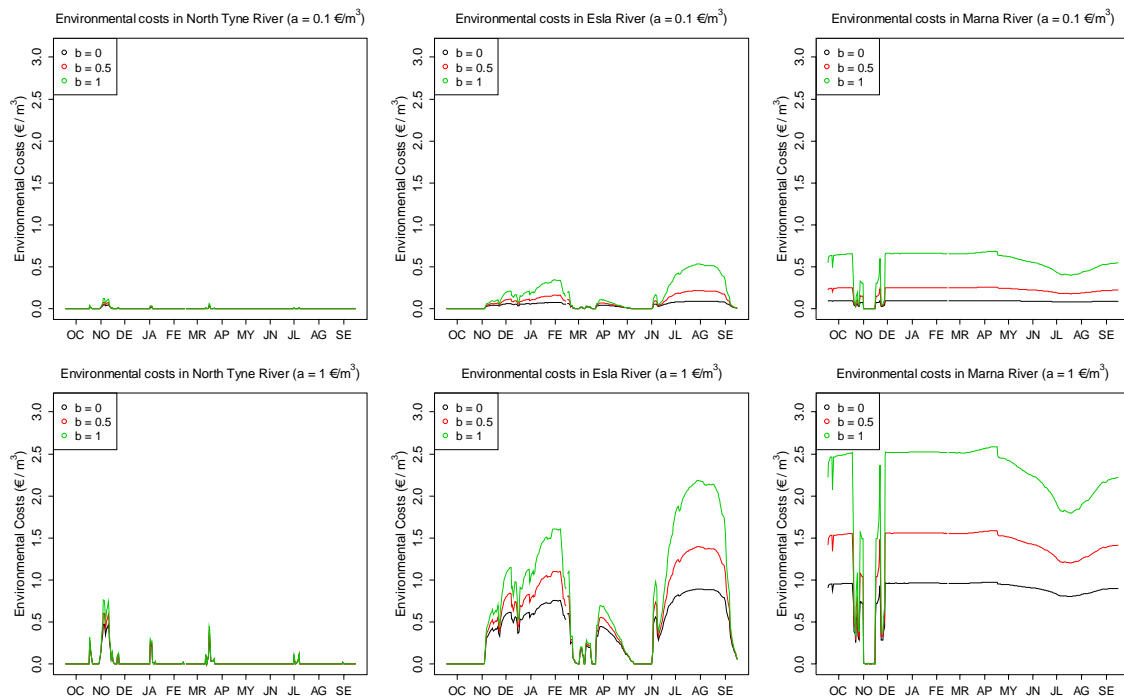

Figure 3. Marginal environmental costs of flow regulation in Tyne River, Esla River and Marna in 2010.

Conclusions

This study develops an approach to assess environmental costs of flow regulation proportionally to the caused environmental impact. We implemented our approach in three European rivers aiming to cover different geographical and socio-economic characteristics. In the three studied rivers, generation of hydro electrical power and irrigation are the main causes of flow regulation. Through a sensitivity analysis, we estimate the water costs that water users should pay for the full cost recovery of water use. This is the first attempt to evaluate the environmental costs of flow regulation which can be very helpful for water managers to assess environmental costs of water use. The main advantage of our approach is that it can be used as a dynamic indicator of water environmental costs which varies according to the environmental damage that the river suffers at every moment. The method allows a clear visualization of environmental impacts and costs of flow regulation which facilitates the communication and discussion among stakeholders. This approach represents a practical tool for water users, that can optimize the most appropriate time of the year for water abstraction minimizing environmental-cost effectiveness; but also Water Authorities may use this approach as justification instrument for setting environmental fees and water prices allocations.

Acknowledgements

The work leading to this paper was funded through the European Union's FP7 programme under Grant Agreement No. 282656 (REFORM).

References

Babulo, B.B., Vinten, A. Slee, B. (2011). A review on cost-effectiveness analysis of agri-environmental measures related to the EU WFD: Key issues, methods and applications. *Ecological Economics* 70: 1021-1031.

- Bitbas, K., Kollimenakis, A., Maroulis, G. Stylianidou, Z. (2014). The water framework directive in Greece. Estimating the environmental and resource cost in the water districts of Western and Central Macedonia: Methods, results and proposals for water pricing. *Procedia Economics and Finance* 8: 73-82.
- Hanley, N., Barbier, E.B. (2009). *Cost-Benefit Analysis and Environmental Policy*. Edward Elgar Publishing Limited, Chenttenham, UK.
- Nilsson, C., Reidy, C. A., Dynesius, M., & Revenga, C. (2005). Fragmentation and flow regulation of the world's large river systems. *Science*, 308(5720), 405-408.
- Poff, N.L., Olden, J.D., Merrit, D.M., Pepin, D.M. (2007). Homogenization of regional river dynamics by dams and global biodiversity implications. *PINAS* 104 (14), 5732-5737.
- WATECO. (2003). *Common implementation strategy for the WFD (2000/60/EC)*. Guidance document 1. Economics and Environment. European Communities, Luxemburg.

Reporting and Predicting Costs of River Restoration Projects

Gerdes H, Lago M & Hinzmann M

HOLGER GERDES, MANUEL LAGO & MANDY HINZMANN

*Ecologic Institute, Pfalzburger Strasse 43/44
D-10717 Berlin, Germany.*

Abstract

Cost-effectiveness analysis (CEA) could be a highly useful instrument for advising the selection of river restoration measures at project level. It enables decision-makers and stakeholders to compare restoration measures ex ante in order to assess which alternatives are financially viable. However, incomplete cost assessments often hamper the evaluation process. In order to support managers in identifying and estimating relevant project costs, this paper discusses the various cost categories related to hydromorphological restoration and develops a cost typology which can serve as a basis for comprehensive cost assessments. Furthermore, the potentials of CEA in the planning and design of river restoration projects are examined. International best-practice examples are presented to show that CEA can play a central role in the process of selecting restoration measures and in determining the appropriate size of the budget and volume of the project. We argue that CEA can be valuable in order to fulfill the environmental objectives of the Water Framework Directive (WFD) by ensuring that the greatest possible restoration effect is achieved.

Introduction

Achieving environmental policy and management objectives to rehabilitate the degraded physicochemical, hydromorphological, and biological elements of rivers requires the implementation of effective restoration measures, and the need to identify and evaluate these measures is growing (Kail and Wolter, 2011). River basin managers and authorities responsible for the implementation of measures to achieve the good ecological status (GES) or good ecological potential (GEP) targets set forth in the Water Framework Directive (WFD) are challenged to prioritize measures that maximize limited public and private budgets while obtaining the greatest positive ecological effects from these investments. A cost-effectiveness analysis (CEA) would be sensible for selecting measures at least costs (Beechie et al., 2008).

The proper assessment of the costs and effects related to the implementation of river restoration measures forms the basis for effective river restoration management. In practice, however, many river restoration projects have not documented project costs (Bernhardt et al. 2005). Deliverable 1.4 of REFORM, which reviewed river restoration projects across the EU, found that in many cases costs had not been assessed in a structured way, thus hampering effective decision-making based on economic assessments, particularly cost-benefit analysis and cost-effectiveness analysis (see Ayres et al. 2014). Moreover, during the 1st Management Cycle of the WFD, the majority of reported RBMPs did not describe the financial commitment, the responsible parties for implementation, the planned timetable, or the expected status improvements to result from the Programmes of Measures (PoMs) (European Commission, 2012). This lack of

information hinders the achievement of the environmental objectives of the WFD not only by making it more difficult to assess whether sufficient action is being taken, but also by not providing a basis to determine whether restoration resources are being used effectively.

Tools are needed that will allow decision makers and stakeholders to assess restoration measures better ex ante. Only by assessing the full spectrum of costs can decision-makers effectively allocate public and private funds and ensure the best ecological outcomes. This paper examines the potentials of CEA to inform decision-making in river restoration projects. In the following, we first examine the types of costs relevant for river restoration and present a cost typology which can be used as basis for a CEA. We argue that a CEA can be highly useful for the planning and design of river restoration actions. To support this view, two practice examples are presented. We conclude with specific recommendations for EU river restoration projects.

Cost categories related to river restoration & development of a cost typology

Regarding the types of costs that are relevant for river restoration actions, as a first step, economic costs (including environmental and resource costs) and financial costs (e.g. capital costs, operation and maintenance costs) can be distinguished. Depending on the policy decision at stake, one can determine which cost types are relevant to be included in an assessment. Specifically, a full cost-benefit analysis would take into account both financial and economic costs, while a financial cost-benefit analysis would not consider economic costs at all. Within a cost-effectiveness analysis, mainly financial costs are considered. The real difference between financial and economic costs lies in the question for whom the costs are assessed, the scope and the scale of the analysis.

Both financial and economic analyses have similar features. Both their goals are to estimate the net-benefits of a project investment against a baseline or counterfactual. Yet some important distinctions worth highlighting for river restoration projects can be made (from WMO, 2007; Lago, 2008). First, the financial analysis compares benefits and costs exclusively relevant to the firm that is asked or encouraged to take some action, while economic analysis aims to choose options that are expected to deliver net benefits to the society at large. Second, in financial analyses market prices are employed to assess investment decisions and ensure their financial sustainability. In contrast, in economic analyses a conversion from the market price by excluding transfer payments (to assess all options net of tax and subsidies) is employed to derive economic prices. Third, while externalities, such as favourable effects on health or the environment, are included in economic analyses, these are not covered in financial analysis. In this paper, we focus on (financial) cost-effectiveness analysis and therefore in the following examine financial costs associated to river restoration projects.

Costs take on many different characteristics, including the time frames during which they must be paid, the purposes (for direct costs) they serve, and the actors who pay them. As such, costs are best reported in a more complex manner than simply a single number. The categories of cost reporting are best informed by economic theory and a sensible breakdown for administrative reasons. Moreover, the costs of restoration projects are affected by many variables, some of which are project-specific, including size of the

installation, and some of which are circumstantial, including regional variations in energy costs, labour costs, and requirements for monitoring and efficiency assessments.¹

In general, the level of detail built into the cost typologies that are currently being used in river restoration projects is rather low. Looking more specifically at river restoration in Europe, cost typologies included in existing databases generally encompass only total project costs. An exception is the RESTORE database set up as part of the RESTORE LIFE+ project, whose cost typology includes total cost information for the following categories: investigation and design, stakeholder engagement and communication, works (i.e. construction works), post-project management, and monitoring. In most cases, however, information is only reported for "works." Looking across the Atlantic, cost reporting in restoration databases does not seem to be appreciably more complex. The US National River Restoration Science Synthesis, as reported by Bernhardt et al. (2005), gathered cost data on thousands of projects implemented across the United States, but costs were only reported in terms of total project costs. Kondolf et al. (2007) worked with the same database alongside a set of interviews in California and pointed out the lack of useful project data for restoration projects, including cost data.

In order to enable river restoration managers to compare project alternatives ex ante and to select alternatives which are financially viable, we propose a cost typology which can serve as a basis for comprehensive cost assessments. Our cost typology is based most closely on the standard WFD-related cost typology which was developed for the CEA of the Programme of Measures (see RPA, 2004). Specifically, we have adopted the non-recurring/recurring costs distinction in order to allow for insight into how costs develop over time. Non-recurring costs are one-off costs while recurring costs refer to regular cost incurred repeatedly, e.g. on an annual basis.

1. Non-recurring costs

- a. Planning and design costs include costs related to a variety of activities that are part of the preparatory project phase, including data collection, setting objectives, identifying outcomes, planning the schedule, identifying activities, developing the budget, selecting the project team, and setting up contingency plans.
- b. Transaction costs may occur in the planning as well as in the implementation phase of the project and include communication charges, legal fees, informational costs, and quality control costs.
- c. Land acquisition costs refer to the cost of the land/property that needs to be acquired for implementing the restoration project.
- d. Other construction / investment costs refer to the cost of the factors which are needed to implement the project, including labour, material, equipment, financing, services, and utilities.

2. Recurring costs

¹ A good illustration is given by Catalinas et al. (2014) who provide a detailed overview of methods and data used for cost estimation for freshwater habitat restoration planning under the WFD in Spain.

- a. Annual maintenance costs refer to up keeping and repair costs which occur over the duration of the restoration project; they are usually reported on an annual basis.
- b. Annual monitoring costs occur after the restoration project has been implemented and refer to costs for labour and equipment that is needed to analyse the changes in ecological and hydromorphological conditions and the effectiveness of the measures implemented; they are usually reported on an annual basis.

The financial cost data covered by these variables should allow for a comprehensive CEA. Financial cost data, collected in the typology both as recurrent and non-recurrent costs, are combined with effectiveness or benefits data in order to establish a ratio or costs to benefits for each individual measure. The measures are then ranked according to their cost-effectiveness. If the restoration target has been defined, summing the potential deployment of the most effective measures will reveal which of them should be implemented to reach the goal at least costs.²

Interest rates, discount rates and depreciation are important variables in a proper financial cost assessment. The discount rate refers to the time value of money. In an investment decision, the discount rate serves as the multiplier that converts anticipated returns from a project to their current market value (present value). In the context of river restoration, the discount rate can be a determining factor when comparing alternative restoration measures. A high discount rate will reduce future costs and benefits while a low discount rate will increase them. In public-sector projects, the discount rates applied are usually in the range between 3.5 and 5.5 percent.³ Depreciation, on the other hand, is a method of allocating the cost of a tangible asset (e.g. built infrastructure) over its useful life, i.e. over the duration of a river restoration project. In a proper costs assessment, the related costs are allocated, as depreciation expense, among the periods in which the asset is expected to be used.

Estimating non-recurring and recurring costs and taking into account discount rates and depreciation thus forms the basis of a proper cost assessment. After the respective cost data have been gathered, they can inform a CEA and support the selection of alternative restoration measures. In order to provide some practical evidence, the following section will review two examples where CEA have been carried out in order to select alternative measures in the context of river restoration projects.

Application of Cost-Effectiveness Analysis in practice

While it has been shown that, across EU Member States, gaps occur with regard to cost estimation and reporting, a number of well-documented river restoration projects can be

² It should be noted that the evaluation of further cost categories (beyond financial costs) can be of importance to decision makers. A full cost-benefit analysis attempts to determine the efficient level of abatement either for one individual measure class or a basin as a whole. As such, the external economic costs of river restoration are needed to understand the full social costs of implementing these measures.

³ The European Commission suggests a discount rate for public investments of 3.5% (and 5.5% for EU Member States with Gross National Income below average) (European Commission, 2008). Furthermore, the UK and France current discount rates for public investments are 3.5% for the first 30 years of a program and 4%, respectively (HM Treasury, 2013 and Evans et al., 2006).

found in the USA. We examined two projects in which a CEA played a central role in the selection of restoration measures.⁴ The first example is the Malden River restoration project. The Malden River watershed is a sub-basin of the Mystic River of approximately 11 square miles and flows through the densely populated cities of Malden, Everett and Medford in Massachusetts. Primary objectives of this comparably small-scale project were the restoration of wetlands, of aquatic habitats as well as of fish migration (USACE 2008, p. ES-i). The second example is the Los Angeles River Revitalization project. The 51-mile-long L.A. River is the central stream of an 870 square mile watershed located in Southern California. It flows through the second-largest urban area of the USA. For the restoration, a restoration area of eleven miles was chosen. Objectives of the restoration project were to restore ecological processes and biological diversity, to increase habitat connectivity and to improve opportunities for recreation (USACE, 2013b).

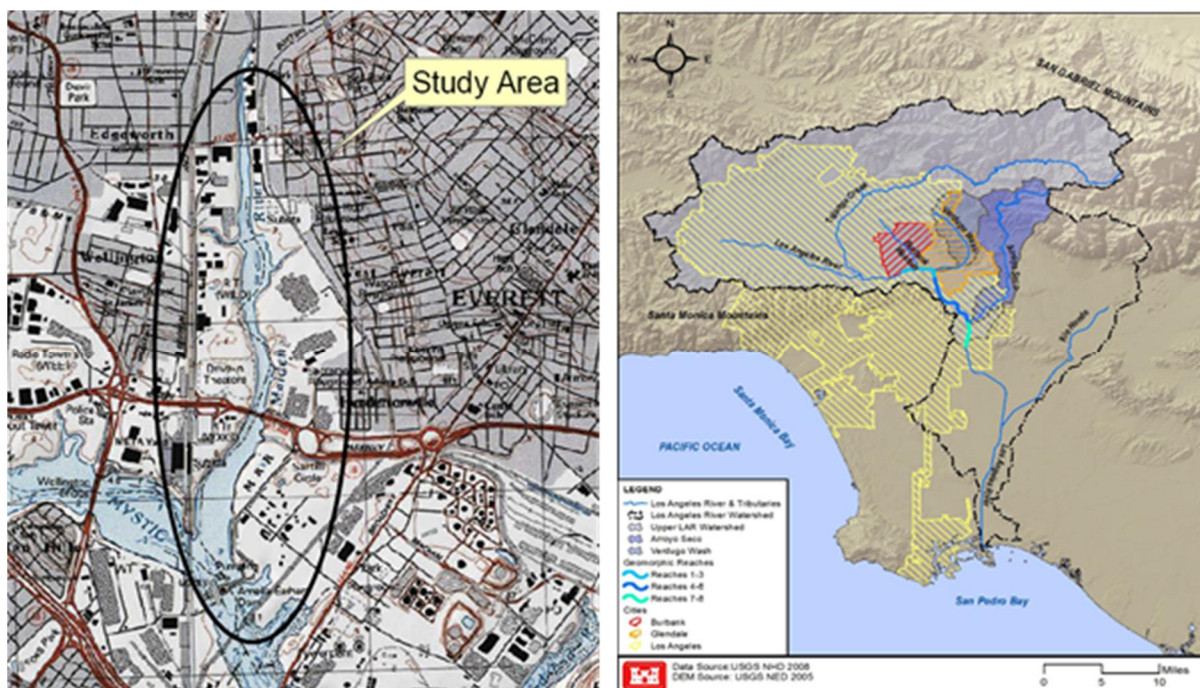

Figure 1. Left: Topographic Map of the Malden River Restoration Project (USACE 2008, p. ES-ii); Right: Los Angeles River Watershed (USACE 2013b, p. 3-2).

Both projects were led by the U.S. Army Corps of Engineers (USACE), whose restoration activities are guided by internal guidelines and policies (see Robinson et al., 1995; U.S. Council on Environmental Quality, 2013). These documents establish a standardized procedure for planning river restoration activities, e.g. they oblige to consider and evaluate a range of reasonable alternatives and prescribe how to calculate costs and benefits. Therefore the two projects presented here followed a similar process. First, the environmental restoration needs and opportunities were identified. Second, restoration alternatives were developed. Next, the costs for the restoration alternatives were

⁴ In both examined projects, an Incremental Cost Analysis (ICA) has been conducted as part of the process. An ICA examines the sequential increase of outputs in order to determine whether increasing levels of restoration are worth the added cost. As the focus of this paper is on CEA, this is not further discussed here.

estimated, using a cost estimation software of the USACE⁵. This was followed by a CEA. The environmental output of each alternative was measured in habitat benefits or habitat units, which were examined in relation to the project costs (for more detail, see USACE 2007, p. C-2, and f). The CEA resulted in a subset of cost-effective plans. Based on this, the most cost-effective plans, i.e. those plans with the lowest incremental cost per unit of output, could be ranked and selected. Finally, based on the results of the cost analysis, a suitable combination of measures can be selected.

- Construction costs (included a contingency for construction of 25%)
- Real estate costs, developed for each alternative and each sub-area
- Relocation costs, e.g. for businesses that would require relocation
- Mobilization and demobilization costs, which includes transporting equipment and crews to the project site, setting up site facilities and staging areas. Mobilization and demobilization costs were estimated to be 7.5% of construction costs.
- Planning, engineering and design costs, which cover the preparation of plans, specifications as well as engineering during construction. These costs were estimated at 11% of construction costs.
- Supervision and administration costs cover the construction management during construction. These costs were estimated to be 6.5% of construction costs.
- Operation and maintenance costs, which are defined as costs for the routine work that is expected to occur each year over the 50-year life cycle of the project. Operation and maintenance costs were estimated by using percentages of the original installation cost for individual items (e.g. concrete demolition).

Box 1: Types of costs used in the CEA of the L.A. River Revitalization Project (USACE, 2013a)

The cost categories considered in the CEA are rather similar in the two examples. In both, construction costs, costs for planning, engineering and design, real estate costs, supervision costs as well as operation and maintenance costs were covered in the analysis. One difference is that in the L.A. project relocation costs as well as mobilization costs for the transport of crew and equipment are included in the cost estimation, while these cost types are not considered in the Malden River project plan. In comparison to the recommended cost typology of this paper, the considered cost types in the U.S. examples are in large part captured by our proposed categories. Regarding the non-recurring costs, planning and design costs as well as land acquisition costs ("real estate costs") were considered in the U.S. projects. Further cost types of the examples, such as the supervision and administration costs, can be assigned to the proposed category "other construction/investment costs". Transaction costs are not explicitly listed in the two project plans. In regard of the recurring cost, only annual maintenance costs were considered in the L.A. and Malden projects, while monitoring costs are not mentioned in the respective cost estimations.

In summary, the two U.S. examples demonstrate the usefulness and applicability of the here promoted cost typology for the practical realization of CEAs in preparation of river

⁵ The software tool 'Automated Procedures for Conducting Cost Effectiveness and Incremental Cost Analyses' assists in carrying out the mechanical calculations necessary to conduct cost effectiveness and incremental cost analyses for the evaluation of environmental restoration or mitigation plans (Robinson et al., 2005).

restoration projects. Moreover, the two examples show a number of benefits of applying a CEA ex ante in the planning and design phase of river restoration projects. In the Malden and L.A. projects, the CEA aided in prioritizing restoration measures and enabled the identification of those alternatives that are most cost-effective in providing environmental benefits. In both projects, the CEA facilitated comparing the suitability of measures in different sub-areas of the designated restoration area. Furthermore, it proved to be useful for the development of cost-effective combinations of measures. In addition, the CEA ensured that the least cost solution was identified for all possible levels of environmental outputs. Regarding the applicability, the two examples show that a CEA is a useful instrument for both small-scale and large-scale restoration projects.

A CEA can also play a role in determining the appropriate size of the budget and volume of a project. In the U.S. examples the budget was yet undecided during the planning phase and the CEA was used as a tool to define and prove the needed financial resources.⁶

Conclusions and recommendations

A cost-effectiveness analysis (CEA) can be a highly useful instrument for advising the selection of restoration measures. It enables decision-makers and stakeholders to compare project alternatives ex ante in order to assess which alternatives are financially viable. Examples of USA river restoration demonstrated the usefulness of a CEA in the planning and design phase. In addition, the cost categories used for the cost assessment of the two presented best-practice examples are quite similar to the cost typology which is recommended in this paper. Therefore we assume that a CEA based on our cost typology would be feasible and broadly applicable in the European context.

For EU river restoration projects, the broad application of CEA could make the decision-making process more transparent and it could aid in determining an appropriate budget. In addition, a CEA can be valuable in order to fulfill the WFD requirements (e.g. justification of disproportionate costs) and to ensure that the greatest possible ecological effect is achieved with a given budget when there are various restoration alternatives available. The widespread application of CEA in European river restoration projects could be facilitated by using the cost typology recommended in this paper.

References

- Ayres, A., Gerdes, H., Goeller, B., Lago, M., Catalinas, M., García Cantón, A., Brouwer, R., Sheremet, O., Vermaat, J., Angelopoulos, N., Cowx, I. (2014): Inventory of river restoration measures: effects, costs and benefits. Restoring rivers FOR effective catchment management (REFORM), Deliverable 1.4 – Inventory with restoration costs and benefits.
- Beechie, T., Pess, G., Roni, P. and Giannico, G. (2008) Setting River Restoration Priorities: A Review of Approaches and a General Protocol for Identifying and Prioritizing Actions. *North American Journal of Fisheries Management* 28, no. 3: 891–905
- Bernhardt, E.S., Palmer, M.A., Allan, J. D., Alexander, G., Barnas, K., Brooks, S., Carr, J., Clayton, S., Dahm, C., Follstad-Shah, J., Galat, D., Gloss, S., Goodwin, P., Hart, D., Hassett, B., Jenkinson, R., Katz, S., Kondolf, G.M., Lake, P.S., Lave, R., Meyer, J.L., O'Donnell, T.K., Pagano, L., Powell, B. and E. Sudduth (2005). Synthesizing U.S. river restoration efforts. *Science*, 308: 636-637

⁶ In contrast, in river restoration projects in the EU, the budget for the project is often granted first, then the CEA is used to decide on which measures are to be realized (e.g. Spain, see Ayres et al. 2014).

- Brouwer, R. (2006). Practical Working Definition Environmental and Resource Costs and Benefits. AquaMoney Deliverable D12. Institute for Environmental Studies, Amsterdam.
- Catalinas, M., Alonso, M., Canton, A. (2014): Cost Estimation For Freshwater Habitat Restoration Planning Under The Water Framework Directive: Practical Approach For Spain. CEDEX, Madrid, Spain.
- European Commission (2008): Guide to Cost-Benefit Analysis of Investment Projects, DG Regional Policy.
- European Commission (2012): Commission Staff Working Document – European Overview (2/2). Accompanying the document: Report from the Commission to the European Parliament and the Council on the Implementation of the Water Framework Directive (2000/60/EC) River Basin Management Plans. Brussels, 14.11.2012 SWD(2012= 370 final. {COM(2012) 670 final}. 139 pages.
- Evans, J. D. (2006): Social discount rates for the European Union. In: Milan European Economy Workshops. Working Papers no. 2006-20.
- HM Treasury (2013): The Green Book: Appraisal and Evaluation in Central Government. TSO: London.
- Kail, J. and Wolter, C. (2011): Die deutschen Maßnahmenprogramme zur Umsetzung der EU-Wasserrahmenrichtlinie in Fließgewässern: Maßnahmen- Schwerpunkte, potenzielle ökologische Wirkung und Wissensdefizite. *Limnologie Aktuell* 13: 251-271
- Kondolf, G., Anderson, S., Lave, R., Pagano, L., Merenlender, A., Bernhardt, E. (2007): Two Decades of River Restoration in California: What Can We Learn? *Restoration Ecology*, Vol. 15(3), 516-23.
- Lago, M. (2008): An Investigation of regulatory efficiency with reference to the EU Water Framework Directive: an application to Scottish Agriculture. (Doctoral dissertation). Retrieved from the Edinburgh Research Archive database.
- Naidoo, R., Balmford, A., Ferraro, P., Polasky, S., Ricketts, T., Rouget, M. (2006): Integrating economic costs into conservation planning. *TRENDS in Ecology and Evolution*, Vol. 21(12): 681-687
- Robinson, R., Hansen, W., Orth, K. (1995): Evaluation of Environmental Investments Procedures Manual-Interim: Cost Effectiveness and Incremental Cost Analyses, IWR Report 95-R-1
- RPA (2004): CEA and Developing a Methodology to Assess Disproportionate Costs. Final report for DEFRA, WAG, SE and DoENI. July 2004.
- USACE - US Army Corps of Engineers, Los Angeles District (2013a): Los Angeles River Ecosystem Restoration. Feasibility Study. Draft – Appendix C. Costs.
- USACE - US Army Corps of Engineers, Los Angeles District (2013b): Los Angeles River Ecosystem Restoration. Volume 1: Integrated Feasibility Report. Los Angeles County, California
- USACE - US Army Corps of Engineers, New England District (2008): Malden River Ecosystem Restoration. Detailed Project Report & Environmental Assessment.
- USACE - US Army Corps of Engineers, New England District (2007). "Malden River Environmental Restoration Project, Medford & Everett Massachusetts. Appendix C: Cost Effectiveness, Incremental Analysis, and Resource Significance.
- U.S. Council on Environmental Quality (2013): Principles and Requirements for Federal Investments in Water Resources
- WMO (2007). Economic Aspects of Integrated Flood Management. Flood Management Policy Series. APFM Technical Document No. 5, WMO No. 1010. World Meteorological Organization, 2007. ISBN: 92-63-11010-7

The economics of river restoration: Experiences throughout Europe in understanding effects, Costs, and Benefits of river restoration projects

Lago M et al.

MANUEL LAGO¹, HOLGER GERDES¹, BRANDON GOELLER², ANDREW AYRES³, MARTA CATALINAS⁴, ANGEL GARCÍA CANTÓN⁴, ROY BROUWER⁵, OLEG SHEREMET⁵, JAN VERMAAT⁶, NATALIE ANGELOPOULOS⁷ & IAN COWX⁷

¹*Ecologic Institute, Berlin, Germany.*

²*Ecologic Institute, Berlin, Germany /School of Biological Sciences, University of Canterbury, Christchurch, NEW ZEALAND.*

³*Bren School of Environmental Science & Management, Department of Economics University of California, Santa Barbara, US.*

⁴*Área de Estudios y Planificación, Centro de Estudios Hidrográficos, CEDEX, Spain.*

⁵*Department of Environmental Economics, Institute for Environmental Studies Vrije Universiteit Amsterdam, The Netherlands*

⁶*Institutt for Miljøvitenskap, Norges miljø- og biovitenskapelige universitet, Norway.*

⁷*Hull International Fisheries Institute, School of Biological, Biomedical and Environmental Sciences. University of Hull, United Kingdom.*

Abstract

More information is needed to help river basin managers to understand the costs and benefits of river restoration to effectively support the drafting of programme of measures for the implementation of the EU Water Framework Directive. This conference paper summarises the findings from a review of the literature on the effects, costs, and benefits of river restoration options throughout Europe that was completed as part of Deliverable 1.4 of the FP7 REFORM project. The paper begins by characterizing commonly implemented river restoration measures in Europe and continues by reviewing available information about their typical effects, costs and ultimately, economic benefits. Finally, the paper aims to highlight from an interdisciplinary perspective relevant lessons learned for water management.

Background

In its most formal sense, the term restoration refers to returning an ecosystem to its original pre-disturbance state; but, in practice, river restoration is used to refer to habitat enhancement, rehabilitation, improvement, mitigation, creation, and other situations (Roni et al., 2005). Some common goals of river restoration are to (i) improve water quality, (ii) re-establish river type-specific habitats and ecosystem functioning, (iii) aid in species recoveries, and (iv) maintain the provision of ecosystem services. This paper considers the objectives of river restoration to include natural processes and their anthropogenic value (i.e., ecosystem services), in addition to the effect on ecological status. Because decisions about river rehabilitation are societal ones, restoration projects that consider human dimensions (e.g., society's need for ecosystem services, conflicting interests of multiple stakeholders, and interactions of environmental policy, economics, and science) are more likely to meet environmental management and policy goals.

Ecological boundaries such as river basins do not conform to political and cultural boundaries, so solving water resource issues requires international understanding and cooperation. While the WFD's river basin approach should allow for increased comprehensiveness in water resources management by expanding it to include policy areas such as land use, flood risk mitigation, navigation, hydroelectric power production, and nature conservation, approaches for integrating these governance responsibilities within river basins and across borders are left to the Member States. Of concern for river restoration is the interplay between hydromorphological quality parameters and land use, navigation, and dam operation. The achievement of relevant environmental objectives (Good Ecological Status and Potential) thus depends on the ability of river basin managers to balance the needs of the WFD with those of these other policy objectives effectively (Moss, 2004).

Balancing such concerns in a transparent manner requires an economic analysis of the impacts of these measures. River basin managers and authorities responsible for the implementation of measures to achieve the WFD GES/GEP goals are challenged to prioritize measures to efficiently use limited budgets while obtaining the greatest ecological and economic returns from these investments. Tools are needed that will allow decision makers and stakeholders to assess restoration measures better *ex ante*. Only by assessing the full spectrum of costs and benefits can decision makers effectively allocate public and private funds and ensure the best ecological outcomes. A framework for this assessment will need to inform future rounds of river basin management planning across Europe. Although predicting ecological responses is of obvious importance, an economic consideration of costs and benefits is essential for rationally managing our rivers.

Introducing economics as a tool for the planning, prioritization, and evaluation of restoration projects is still in its infancy (Robbins and Daniels, 2012; Naidoo et al., 2006). In a meta-analysis of 1,582 recent peer-reviewed papers dealing with ecological restoration, Aronson et al. (2010) found that restoration scientists and practitioners are failing to show the links between the socio-economics and ecology of restoration, underselling the evidence for restoration as a worthwhile environmental and societal investment. While broad overviews of restoration prioritization for river basin managers and practitioners are available in the published literature (e.g., Roni et al., 2002; Beechie et al., 2008; Roni et al., 2008), a rationalized economic analysis to guide decisions and investments in restoration measures and to elicit the greatest impact (i.e., socio-economic and environmental benefits of restoration measures) is needed.

This paper set in the framework of the EU FP7 Project REFORM, reviews the literature on costs and benefits of river restoration. Data were collected in a database in order to empirically investigate the costs and benefits of river restoration measures throughout Europe. Also, a summary of restoration planning and the specific measures which can inform the future development of cost-benefit analysis and their application are introduced. A non-exhaustive review of peer-reviewed literature and technical reports is conducted to elicit the effects of individual measures, providing a basis for the analysis of restoration benefits. This research lays the basis for a framework for valuing the ecosystem services that link ecological function to societal welfare, in order to inform the creation of tools and guidelines to help river basin managers assess the promise of restoration projects *ex ante*.

DATABASE

In the following section, a short introduction to the database used to gather data for the analysis of costs, effectiveness, and benefits of European river restoration measures is given. Databases of river restoration measures exist in many formats, including open wikis (such as the REFORM⁷ and RESTORE⁸ wiki databases) operated by research organisations or NGOs, databases compiled by engineering or consulting firms (such as the WFD Hydromorphology Measures Database of Royal Haskoning, which covers England and Wales) from previously implemented projects, and lists of approved measures gathered by various governmental agencies.

The database was designed to gather data on the costs of the reported measures while also collecting sufficient information to enable marginal cost-benefit and cost-effectiveness analyses by way of statistics on effectiveness and monetary benefits. These analyses require information on the costs and benefits of measures, the average unit costs of their implementation, and the relationship of these costs to the size of the project.

The database⁹ consists of four individual sheets:

- "*Measure Info*" was designed to collect basic information on the measures, including the necessary information to categorise within the measure typology.
- "*Effects*" captures any available data on the effects resulting from the reported measures.
- "*Costs*" was designed to collect very detailed data regarding implementation, design, maintenance, and management costs, should this data be available.
- "*Benefits*" contains existing benefits estimates for the implemented river restoration measures.

The cost database contains cost data for 766 restoration measures from Germany (454), Spain (228), the United Kingdom (54), and the Netherlands (30). Ten of the UK cost data referred to overall project costs, rather than individual measures, and therefore, these data were not included in the data analysis. Cost data were reported as total investment cost per unit for the implementation of individual measures. Fifty-nine percent of the data (all German data) were estimated costs (n=454), and the remaining 41% of the data from ES, NL, and the UK were actual reported total unit costs from restoration projects (n=312).

To provide a finer spatial resolution to the restoration measures in the database and to enable future scaling-up of costs, effects, or benefits, project data were assigned a river typology, based on the river types developed within Deliverable 2.1 of REFORM (Gurnell et al. 2014). Table 1 below depicts the distribution of the measures found in the database according to the FORECASTER measure typology (Ayres et al. 2014, Annex 1).

⁷ http://wiki.reformrivers.eu/index.php/Main_Page

⁸ <https://riverwiki.restorerivers.eu/>

⁹ <http://www.reformrivers.eu/inventory-river-restoration-measures-effects-costs-and-benefits>

Table 1. Distribution of measures per country according to the FORECASTER typology.

Measure	Germany	Spain	UK	Netherlands
Flow Quantity (1)	1%	0%	0%	0%
Sediment Flow Quantity (2)	4%	29%	5%	23%
Flow Dynamics (3)	1%	0%	0%	0%
Longitudinal Connectivity (4)	21%	32%	7%	55%
Depth and Width Variation (5)	13%	0%	53%	9%
In-channel Structure and Substrate (6)	27%	7%	19%	9%
Riparian Zone (7)	4%	11%	7%	5%
Floodplains/Lateral Connectivity (8)	29%	21%	9%	0%
Total of Measures	453	228	45/55	30

RESULTS

Common restoration measures in Europe

A non-exhaustive review of the most commonly used river restoration measures shows that it is extremely difficult to predict the impacts of specific river restoration measures on a European-level. The river type, based on geomorphological and functional process units, as well as the specific anthropogenic pressures are relevant for choosing suitable restoration measures. Practical limitations such as land availability, project budget, and/or stakeholder consent limit the spatial extent to which rivers can be restored. Ultimately, WFD Programme of Measures should address the type and scale of pressures in a river basin, provide long-lasting improvements, and be robust against the impacts of climate change. The review of the literature illustrates that independently of the type of restoration measures, considering the hydrogeomorphological processes affecting a river restoration site and implementing this information into the project design is critical to elicit the maximum ecological benefits from the proposed measures.

For each country in the database (DE, ES, NE, UK), expert judgment was used to assign the project data to one of the simple river classification types from Gurnell et al. 2014. River planform, slope, and the bed material caliber were the most useful criteria to guide the matching of river types to the restoration data. To avoid making false judgements when assigning river types to projects with unclear or insufficient information, it was sometimes necessary to assign multiple river types to a specific restoration project. The breakdown of measures per country and river type is presented in Table 2.

Table 2. Overview of the implementation of measures from the cost database in specific river types*

Country	River Type	Measures**																
		1	2	2.2	3	4	4.1	4.2	5	5.1	6	6.6	6.7	7	8	8.2	8.3	8.4
Spain	2						x	x										
	3			x			x	x			x			x	x			
	5			x							x			x	x			x
	7													x	x			x
Germany	3	x	x	x		x	x	x	x	x	x	x	x	x	x	x	x	x
	5	x	x	x	x	x	x	x	x	x	x			x	x	x	x	x
Netherlands	5		x				x	x	x	x		x			x			
UK	1									x								
	2									x	x			x	x			
	3		x				x	x	x	x	x	x	x	x	x		x	
	5					x	x		x	x	x	x	x	x	x		x	
	7									x	x	x			x			

* Measures refer to the classes (1-8) and subclasses (1.1-8.9) of the FORECASTER measure typology. Only the measures subclasses occurring most often in the cost database are shown, which are the most relevant for analysis.

**Measure and Measure Subclass Names

1 Water flow quantity improvement

2 Sediment flow quantity improvement; 2.2 Reduce undesired sediment input

3 Flow dynamics improvement

4 Longitudinal connectivity improvement; 4.1 Remove barrier; 4.2 Install fish pass/bypass/side channel for upstream migration

5 River bed depth and width variation improvement; 5.1 Remeander water courses

6 In-channel structure and substrate improvement; 6.6 Remove bank fixation; 6.7 Recreate gravel bar and riffles

7 Riparian zone improvement

8 Floodplains/off-channel/lateral connectivity habitats improvement; 8.2 Set back embankments, levees or dikes; 8.3 Reconnect backwaters and wetlands; 8.4 Remove hard engineering structures that impede lateral connectivity

Effectiveness

In this section, the expected ecological benefits of the restoration measures in the cost database are presented. The literature reports many successful river restoration measures, which support improvements to hydrology, hydromorphology, water chemistry, biota, or ecosystem services. The summary findings of the non-exhaustive literature review on the ecological effects of restoration measures to the WFD Biological Quality Elements macrophytes, macroinvertebrates, and fish are presented in table 3.

Table 3. Expected ecological effects of restoration measures on aquatic macrophytes, benthic macroinvertebrates, and fish.

Measure Class	Measure Subclass	General Effects		
		Macro-phytes	Macro-invertebrates	Fish
01. Water flow quantity improvement	Measures class overall	+	++	++
02. Sediment flow quantity improvement	Measures class overall	+	++	++
	02.2 Reduce undesired sediment input	+	+	+
03. Flow dynamics improvement	Measures class overall	+	++	++
04. Longitudinal connectivity improvement	Measures class overall	0	++	+++
	04.1 Remove barrier	0	++	+++
	04.2 Install fish pass/bypass/side channel for upstream migration	0	+	+++
05. River bed depth and width variation improvement	Measures class overall	++	++	++
	05.1 Remeander water courses	++	++	++
06. In-channel structure and substrate improvement	Measures class overall	+	++	++
	06.6 Remove bank fixation	++	++	++
	06.7 Recreate gravel bar and riffles	0	++	++
07. Riparian zone improvement	Measures class overall	-	++	++
08. Floodplains/off-channel/lateral connectivity habitats improvement	Measures class overall	+	++	++
	08.2 Set back levees, embankments, or dikes	+	+	++
	08.3 Reconnect backwaters and wetlands	++	++	+++
	08.4 Remove hard engineering structures that impede lateral connectivity	+	++	++

Legend: - negative, 0 neutral, + slightly positive, ++ moderately positive, +++ highly positive

Although this type of clear-cut and generalized information is useful to river managers and decision makers as reference point to compare the impacts of single measures (for example under the framework of a Cost-Effectiveness Analysis), this exercise does not encompass the full spectrum of complexity and uncertainty surrounding restoration impacts. The response of biota to habitat improvements may be confounded or delayed by many factors, including: migration barriers, the lack of a colonizing source population, the isolation of restored habitat reaches, long-term recovery processes, the creation of inappropriate/unsuitable habitat conditions, or biotic interference resulting from competition, predation, or invasive species. Also, the impacts of large-scale pressures which are not addressed by reach-scale restoration can override the hydromorphological

improvements made by reach-scale restoration measures (e.g., catchment land use, water quality, missing source populations, etc.). Careful treatment of the environmental framework conditions and site-specific socio-economic constraints is necessary to elicit the ecological benefits of river restoration.

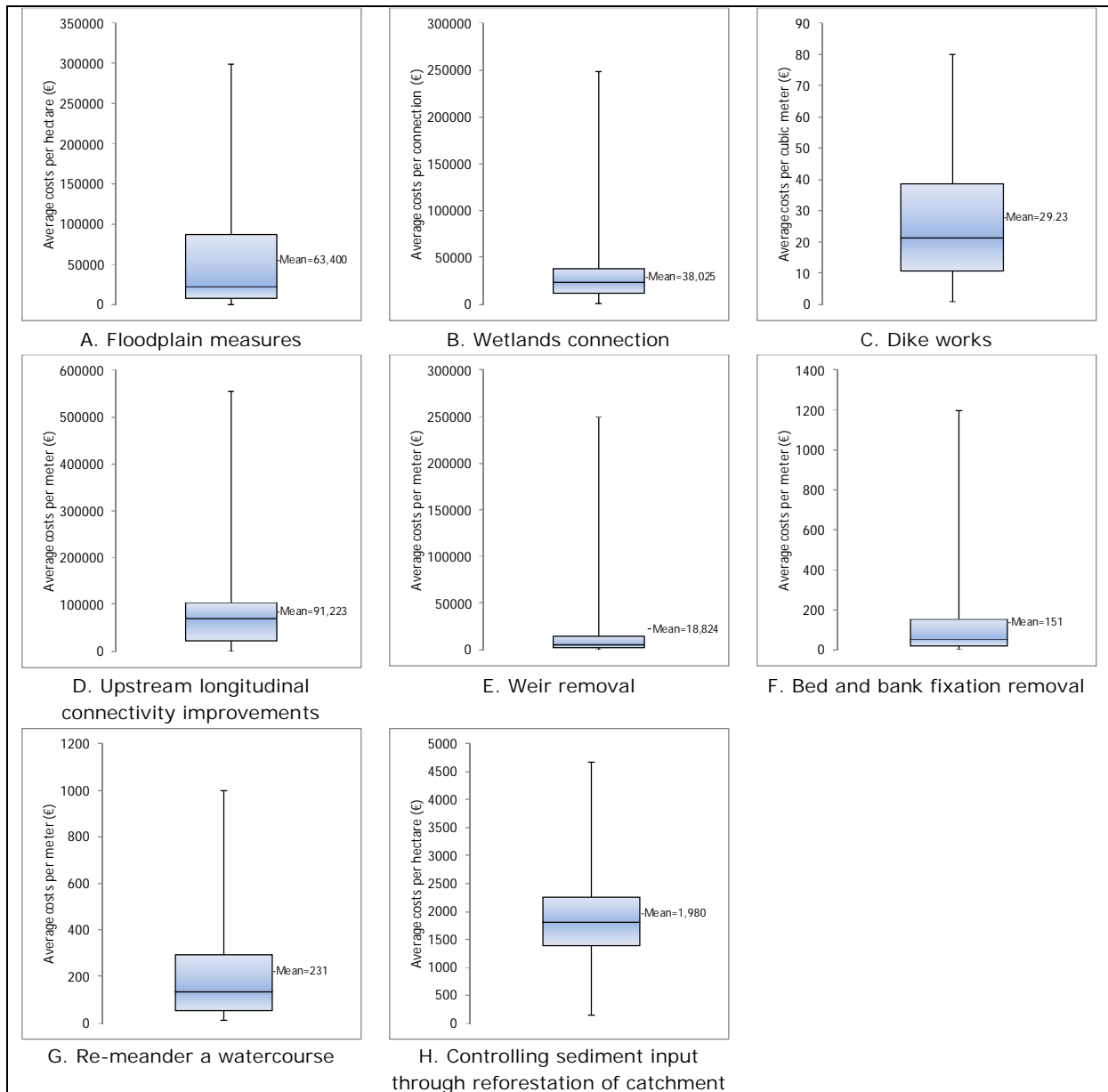

Figure 1. Unit costs for selected measures.

Costs

The following chapter explains how European cost data was gathered and outlines the results of a preliminary economic analysis. This data can help inform a decision-making framework for river basin managers by providing examples of how cost data could be gathered and analysed, in addition to providing representative values for the costs of some restoration measures (cf. Gerdes et al. 2015).

Two specifications were developed for the assessment of total and average abatement costs for each measure. One specification (expanded) includes all comparable cost observations, including cost estimates from Germany and the Netherlands that have by necessity been assigned a project size of one unit. Their inclusion does not bias the cost data presented as average unit costs. The other specification (restricted) includes only those observations that are reported from actual project implementation. This specification was used for plotting the relationships between costs and project size. Reported in Figure 1 are average unit costs that include all comparable observations for the identified river restoration measures—in other words, the expanded sets. All costs are non-recurring. Figure 1 displays cost unit information for each of the assessed measures (graphs A to H), allowing for a direct comparison of the reported costs. For the analysis, cost estimates (lower-bound, average, and upper-bound) and reported project costs have been combined. The cost database also allows for a restricted analysis of the individual cost types.

The cost data collected here exhibit great variability both within measure categories as well as overall: many measure groups exhibit coefficients of variance greater than 1, and the mean project costs for the various measures are also very disparate. An assessment of the relative variability of the cost data must inform further economic applications, and high cost variability relative to the spread of benefits would provide another basis to suggest that any decision-making tool designed for use by water managers must be sensitive to the costs of restoration options.

Economic Benefits

Ecosystem services resulting from hydromorphological river restoration were also evaluated as the environmental benefits provided by restored river ecosystems and riparian zones. The results on the river restoration studies are summarized in section 6.5 of Deliverable 1.4 of REFORM (Ayres et al. 2013). The majority of reviewed studies, 23 out of 30, assume that the main beneficiaries of river restoration are local households and use different forms of contingent valuation studies or discrete choice experiments to elicit their valuation of the restoration projects. The benefits of re-introduced or expanded ecosystem services provided by a restored river are equalized to welfare improvements resulting from the changes, and are calculated as a willingness to pay for river restoration.

As a rule, restoration projects are often treated as a bundle of ecosystem services, which made it very difficult to determine values for these services individually or as a whole. In Europe, the academic papers included in the database report valuation results for rivers in the UK, Germany, Austria, Spain, Sweden, Denmark, Ireland, and Albania. Most WTP estimates are within the 25-80 EUR range, with 25-40 EUR being the median range. In addition, several studies report the marginal WTP for attributes, which allows, at least tentatively, the evaluation of improvements in selected individual environmental benefits, e.g., higher water quality –25-30 EUR, or better aesthetics –16-25 EUR. It should also be taken into account that there is a clear difference in WTP estimates between developed and developing countries. For example, in China, Bangladesh, Mexico, and also in selected studies in Spain, the WTP estimates are in range of 2.3-7.9 EUR (PPP adjusted). At the same time, in the USA, the reported WTP values are within the 13-122 EUR range. Overall, these findings are close to earlier valuations of ecosystem services.

Conclusions

The database was designed to gather data on the costs of reported river restoration measures. Further conclusions from the analysis of the database is that the cost data for most measures varies considerably, which ultimately restricts the conclusions that could be drawn from the exercise. This suggests that investing efforts in gathering and incorporating cost information into decision making is a prerequisite to increase the efficiency of river restoration activities. Results are potentially useful to inform the development of protocols to improve cost data collection for the further application of decision making tools (marginal cost curves and cost-effectiveness analysis) which with sufficient information can offer a systematic way of illustrating further application of the cost analysis in practical implementation of the measures. Our proposals are included in Gerdes et al. 2015. For the implementation of the WFD, a cost-effectiveness analysis of restoration measures can help to ensure that the least-cost options for achieving Good Ecological Status are chosen for the Programmes of Measures (PoM). However, only by assessing the full spectrum of costs and benefits can decision makers effectively allocate public and private funds and ensure the best ecological outcomes of investments in river restoration. A rationalized economic analysis to guide decisions and investments in restoration measures and to elicit the greatest impact (i.e., socio-economic and environmental benefits of restoration measures) is needed.

References

- Aronson, J., Blignaut, J.N., Milton, S.J., Le Maitre, D., Elser, K.J., Limouzin, A., Fontaine, C., De Wit, M.P., Mugido, W., Prinsloo, P., Van Der Elst, L. & Lederer, N. (2010). Are Socioeconomic Benefits of Restoration Adequately Quantified? A Meta-analysis of Recent Papers (2000-2008) in Restoration Ecology and 12 Other Scientific Journals. *Restoration Ecology*, 18, 143-154.
- Ayres, A., Gerdes, H., Goeller, B., Lago, M., Catalinas, M., García Cantón, A., Brouwer, R., Sheremet, O., Vermaat, J., Angelopoulos, N., Cowx, I. (2014): Inventory of river restoration measures: effects, costs and benefits. Restoring rivers FOR effective catchment management (REFORM), Deliverable 1.4 – Inventory with restoration costs and benefits.
- Beechie, T., Pess, G. & Roni, P. (2008). Setting River Restoration Priorities: A Review of Approaches and a General Protocol for Identifying and Prioritizing Actions. *North American Journal of Fisheries Management*, 28,891-905.
- Gerdes, H., Lago, M. & Hinzmann, M. (2015). Reporting and predicting costs of river restoration. Conference paper, REFORM International Conference on River and Stream Restoration "Novel Approaches to Assess and Rehabilitate Modified Rivers", Wageningen, July 2015.
- Gurnell, A.M. et al. (2013). A hierarchical multi-scale framework and indicators of hydromorphological processes and forms. Restoring rivers FOR effective catchment management (REFORM), Deliverable 2.1 Part 1.
- Moss, T. (2004): The governance of land use in river basins: prospects for overcoming problems of institutional interplay with the EU water framework directive. *Land Use Policy*, 21, 85-94
- Naidoo, R., A. Balmford, P. Ferraro, S. Polasky, T. Ricketts, & M. Rouget (2006). Integrating economic costs into conservation planning. *TRENDS in Ecology and Evolution*, 21(12), 681-687.
- Robbins, A.S.T. & Daniels, J.M. (2012). Restoration and Economics: A Union Waiting to Happen? *Restoration Ecology*, 20(1):10-17.
- Roni, P., Beechie, T.J., Bilby, R.E., Leonetti, F.E., Pollock, M.M. & Pess, G.R. (2002). A Review of Stream Restoration Techniques and a Hierarchical Strategy for Prioritizing Restoration in Pacific Northwest Watersheds. *North American Journal of Fisheries Management*, 22,1-20.
- Roni, P., Hanson, K. & Beechie, T. (2008). Global Review of the Physical and Biological Effectiveness of Stream Habitat Rehabilitation Techniques. *North American Journal of Fisheries Management*, 28, 856-890.
- Roni, P., Hanson, K., Beechie, T., Pess, G., Pollock, M. & Bartley, D.M. (2005). Habitat rehabilitation for inland fisheries. Global review of effectiveness and guidance for rehabilitation of freshwater ecosystems. FAO Fisheries Technical Paper No. 484. Rome, FAO. 116 pp.

Restoration of Narew national park buffer zone in context of ecosystem services

Tylec L et al.

LUIZA TYLEC¹, MAREK GIEŁCZEWSKI¹ & JAN VERMAAT²

¹Department of Hydraulic Engineering, Warsaw University of Life Sciences, Warsaw, 159 Nowoursynowska Street, 02-776, Poland

²Instituttleder, Institutt for Miljøvitenskap, Norges miljø- og biovitenskapelige Universitet, Fougnerbakken3, 1430 Ås, Norge

River ecosystems are important elements of the European landscapes. They provide important services for human well-being. Europe's rivers have been degraded by human activities in the floodplain and by direct interference with the channel. River restoration is complicated and long process which consumes time, work and large financial costs. Restoration aims to increase the quality of water resources so that future generations can also use them. After restoration it is necessary to evaluate the effects to assess importance and cost-effectiveness of undertaken actions.

The aim of the paper was to assess the effect of restoration in the context of ecosystem services by comparing quality and quantity of chosen ecosystem services before and after the restoration.

In this regard an ecosystem services evaluation was conducted. The bases for the analysis were maps of the land use. For the state before restoration – historical topographic maps, and for the state after the restoration – CORINE Land Cover 2006 maps were analyzed. All analysis were made by using ArcGIS 10.2.2 software. The recognized types of land use were assigned to the appropriate services ecosystems. Later on using data from Central Statistical Office and algorithms monetary values were calculated for each ecosystem service in biophysical units (e.g. €/ha/year). Algorithms were created by research team. Assigning a monetary value allowed for comparison of the quality and quantity of services existing in this area before and after restoration. In the current situation ecosystem services have increased in terms of their quantity and quality. Analysis of changes in ecosystem services is useful in further planning of restoration scenarios.

Introduction

River ecosystems are important elements of the European landscapes, they provide an important services for human well-being. Europe's rivers have been degraded by human activities in the floodplain like urbanization, agriculture and industry, and by direct interference with the channel, e.g. navigation, flood protection and hydropower. River regulations have an impact on biodiversity, hydrology, water quality and recreation.

River restoration is complicated and long process which consumes time, work and large financial costs. Restoration aims to increase the quality of water resources so that future generations can also enjoy them. After restoration it is necessary to evaluate the effects to assess importance and cost-effectiveness of undertaken actions.

Ecosystem services, directly related to human well-being, are a way of perceiving a quality of the environment that is gaining popularity in recent days, also because it attempts to bridge the gap between social and natural sciences approaches. To use the services provided by the river we need to prevent deterioration and improve the quality of river ecosystems. In a number of European countries actions to restore rivers have been taken. International and national programs of restoration, and programs to verify the effects of restoration were created.

The aim of the paper was to assess the effect of restoration in the context of ecosystem services by comparing quality and quantity of chosen ecosystem services before and after the restoration.

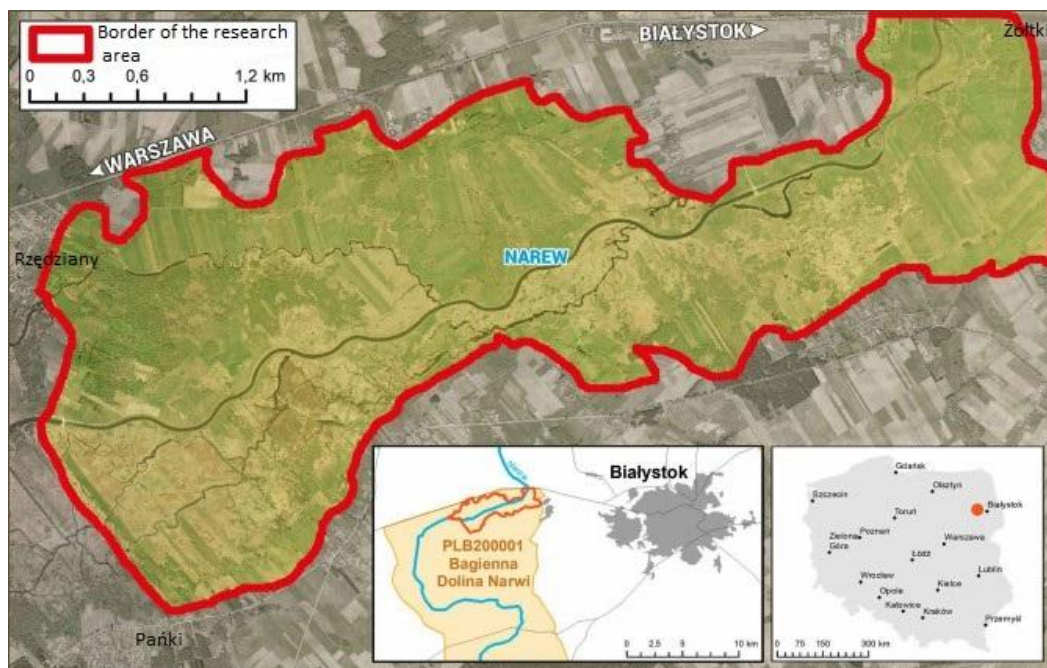

Figure 1. The Narew river restoration project concentrates on the area on the buffer zone of Narew National Park (NPN) which was created in 1996. The restored part of the river is located between Rzędziany-Pańki levee and the road bridge in Żółtki village, in podlaskie voivodeship.

Study area

Narew river is located in North-east Poland. It lies in the areas of three voivodeships: warmińsko-mazurskie, podlaskie and mazowieckie. Narew is a river with total length of 484 km, where 448 km flows in Poland, and the rest in Belarus where is the river's source. Area of the catchment is 75 200 km². The main tributaries of Narew: right: Czarna, Horodnianka, Nereśl, Biebrza, Pisa, Wkra.; left: Narewka, Awissa, Ślina, Bug. On Narew river two reservoirs were created: Siemianowskie Lake and Zegrzyńskie Lake.

The study area for this work embraces sections of the Narew river located in the area of buffer zone of Narew National Park. The total area of buffer zone is 13.4 km². This is special protection area for endangered species of birds (Nature 2000 sites).

Restoration project

Changes in hydrological conditions, caused by river regulation and drainage treatments, are negative for agriculture and natural environment. New formed, deep and wide, riverbed resulted in a reduction or loss of water flow in old river beds. Level of groundwater and surface water was reduced. Also the frequency and severity of local floods during spring and summer was reduced. Nowadays habitat transformations are caused, not only by the river regulation, but also by the changes in intensity and forms of agriculture and natural processes. Due to a decrease of profitability of agriculture on hardly accessible areas, people stopped mowing wet meadows and rushes.

In 1990 the North-Podlaskie Society for Bird Protection (now Polish Society for Bird Protection, PTOB) started project called Project Narew. The main aim of this project was protection of environment in Marshy Valley of the Narew (Natura 2000 site code PLB200001) with a special consideration of hydrological conditions and integrated program of economic development. The work proceeded in stages and focuses on restoring anastomosing system of Narew river.

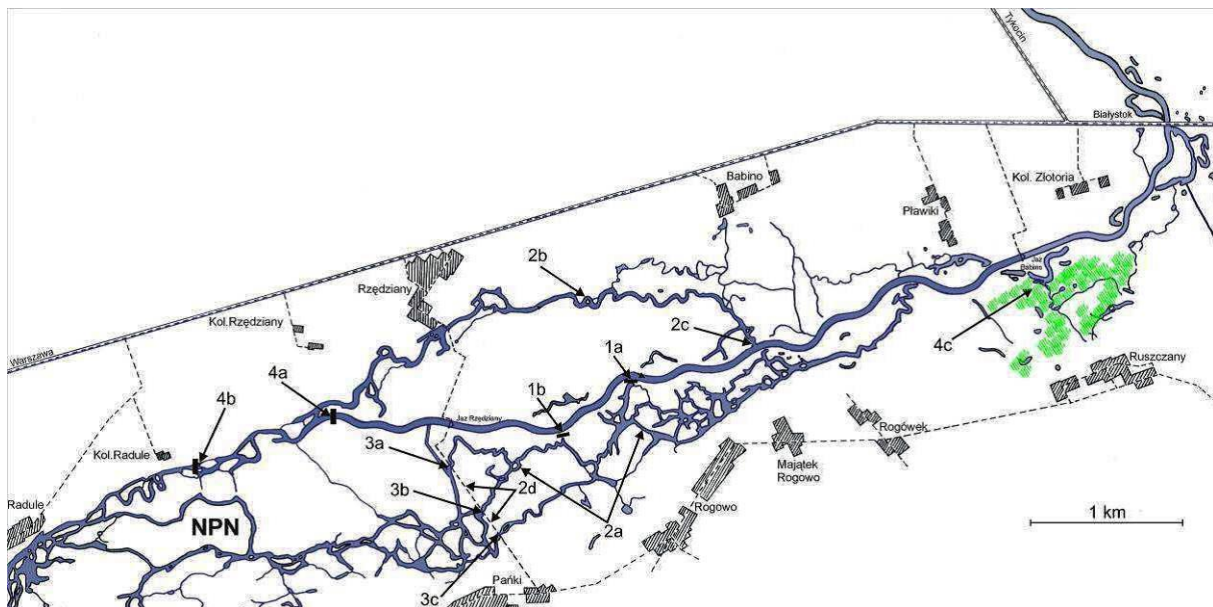

Figure 2. Location of restoration actions below the borders of Narew National Park (Wolkowycy et al., 2011) Explanations: 1a-dam with average damming 95cm; 1b-water threshold with average damming 95cm; 2a-cleaning of old riverbeds in Rogowo village and Majątek Rogowo village; 2b- activation of old riverbed in Babino village; 2c-demolition of the concrete culvert; 2d-activation of old riverbeds in Pańki village; 2e-two culverts on levee; 3a,b,c-wooden bridges; 4a-water threshold built in 2010; 4b-water threshold built in 2007; 4c-meadows restored in 2008; 5a-viewing tower.

Restoration of the rivers and their floodplains is complex, difficult and long process. Bringing back a river to the same natural status as before regulation is impossible. The aim of the Project Narew was to restore natural values of Narew valley to as natural status as it is possible. To check the effects of the undertaken actions inventories and surveys were performed by the Polish Society for Bird Protection. The results of these investigations showed real effects of this project. All results provided in this subchapter are based on publication An assessment of the effects of renaturalization of the buffer zone Narew National Park.

Restoration contributed to stop negative habitat transformations. Groundwater level now is higher, processes of creation of half-bog soil are stopped or slower in some parts of valley. Hydro chemical measurements showed that restoration has positive influence on nitrogen reduction in the water. It proves that nitrogen is used by macrophytes, and that mineralization of peat is smaller.

Methods & results

The Corine Land Cover 2006 data needed for the analysis were obtained for the Narew River catchment area covered by the project Restoring rivers FOR Effective catchment management. To further analyze the land use data has been, using ArcGIS 10.2, cropped to the area of the NPN buffer zone. Land use of the area before the restoration has been determined on the basis of historical maps from the years 1950-1960 also using ArcGIS 10.2. The recognized types of land use were assigned to the appropriate services ecosystems.

For the economic analysis data from the Central Statistical Office (GUS) were used. For the area after the restoration data from 2012 were used. The area before the restoration has been valorized based on the oldest possible to obtain data from the Central Statistical Office and the application of appropriate index conversion. The index has been used because of the denomination of PLN in 1995.

Later on using data from Central Statistical Office and algorithms monetary values were calculated for each ecosystem service in biophysical units (e.g. €/ha/year). Algorithms were created by research team. Assigning a monetary value allowed for comparison of the quality and quantity of services existing in this area before and after restoration.

All economic values were brought to a common denominator for a better comparison. In the current situation ecosystem services have increased in terms of their quantity and quality. Analysis of changes in ecosystem services is useful in further planning of restoration scenarios.

References

- Boyd J., Banzhaf S. (2006): What Are Ecosystem Services? The Need for Standardized Environmental Accounting Units, Resources For the Future, Washington
- Deptuła B. (2002): Narew National Park versus local society [in Polish], National Parks 3 Millennium Ecosystem Assessment (2005a): Ecosystems and human well-being: synthesis. Preface and summary for decision-makers. Island Press, Washington DC, USA
- Mioduszewski W. (1999): Conception of restoration of the Narew valley on section line Rzędziany-Żółtki. Current issues of wetlands protection [in Polish], seminar materials no 43, IMUZ, Falenty
- Ochrymiuk D. (1996): Restoration project of the Narew river on section line Rzędziany-Żółtki (Pre-conception) [in Polish], Białystok
- Ochrymiuk D. (2005): Changes in the avifauna of the Narew valley on the section line Rzędziany-Żółtki due to restoration works [in Polish], Zakład Ekologii Zwierząt, master thesis, Białystok
- Suchowolec A., Deonizak K., Grygoruk G., Hermaniuk A., Jakatierynczuk-Rudczyk E., Kamocki A., Karpowicz M., Kołos A., Jao Matos da Costa, Pućkowski M., Sielezniew M., Suchowolec T., Wereszczuk A., Wołkowycki D., Zieliński P., (2012): An assessment of the effects of renaturalization of the buffer zone Narew National Park [in Polish], Polskie Towarzystwo Ochrony Patków, Białystok
- Wołkowycki D., Kołos A., Kamocki A. (2011): Diversification and habitats status in the buffer zone Narew National Park [in Polish], report, Białystok
- Żelazo J. (2006): Restoration of rivers and their valleys [in Polish], Infrastruktura i ekologia terenów wiejskich, no 4/1/2006, pp.11-31, Polska Akademia Nauk, Kraków

Radwan S. (2003): Natural basis for protection and restoration of wetland ecosystems in the functional area of peat Polesie national park against anthropogenic transformation of the natural environment [in Polish], Acta Agrophysica 91, Katedra Hydrobiologii i Ichtiologii, Akademia Rolnicza w Lublinie.

8. BENEFITS OF RIVER REHABILITATION AND SYNERGIES WITH OTHER USES (FLOOD PROTECTION, NAVIGATION, AGRICULTURE, HYDROPOWER)

Using Hydroscares to maximize the benefits of riparian corridor restoration for multiple river ecosystem services

Barquín J et al.

JOSÉ BARQUÍN¹, LEE BENDA², DANIEL MILLER², MARIO ÁLVAREZ-CABRIA¹, FRANCISCO J. PEÑAS¹, ANA SILIÓ¹, JOSÉ M. ÁLVAREZ-MARTÍNEZ¹ & ÓSCAR BELMAR¹

¹*Environmental Hydraulics Institute, Universidad de Cantabria "IH-Cantabria", C/ Isabel Torres nº 15, Parque Científico y Tecnológico de Cantabria 39011, Santander, Spain*

²*Earth Systems Institute, Mt. Shasta, California, Seattle, Washington, USA*

Riparian corridors play a major role in determining river ecosystem functioning as they control bank erosion and river morphology, they generate habitat heterogeneity within the channel, banks and floodplain, they influence nutrient and organic matter inputs, they buffer against sharp changes in water temperature and they constitute an important habitat for many riverine species. However, the assessment of riparian corridor conservation status has rarely been achieved continuously for entire river networks and linked to ecosystem functioning impairment. This prevents the elaboration of catchment restoration planning that maximizes multiple ecosystem functions. In this study we have assembled a large spatial scale (120.000km²) database from northern Spain which incorporates different riverine ecosystem components. We delineated and characterized Hydroscares for all the major river networks included in the study domain and produced a continuous conservation status riparian corridor assessment. This diagnosis was then used to prioritize river reaches for riparian restoration which maximized bank erosion protection, water temperature control, nitrate runoff and enhanced floodplain habitats.

Introduction

Riparian zones develop several ecological and hydrological functions which are basic for river ecosystems. Despite this, riparian areas are under huge pressure due to land-use transformation and human infrastructures. Moreover, there is a growing consensus that a catchment scale perspective that considers the complete fluvial landscape is critical for successful river restoration. Different catchment approaches have been recently developed that encompass the analysis of many fluvial landscape characteristics for restoration purposes (Benda et al. 2011), but no for riparian vegetation. Most methods assessing riparian quality are based on recording woody vegetation attributes (e.g., width, continuity, composition, regeneration) within homogeneous river stretches not longer than 500 meters, what prevents a continuous evaluation of the riparian corridor (Fernández et al. 2014). One of the major drawbacks to evaluate riparian quality for entire river networks is the lack of a common consensus to delineate riparian zones, whose limits are fuzzy. However, different recent approaches based on GIS technologies allow delineating these areas following hydro-geomorphologic criteria (Fernández et al. 2012). These approaches allow producing riparian quality maps to whole catchments and, thus, relationships among riparian quality data and different ecosystem functions (e.g., bank erosion control) can be explored at large scales. In the present study we aim to (1) delineate riparian zones for entire river networks using hydro-geomorphological criteria, (2) produce a riparian quality model based on land cover of woody vegetation and field observations and, finally, (3) prioritization of river reaches for riparian

restoration by linking riparian quality to the provisioning of 4 ecosystem functions and components: bank erosion control, control of nutrient runoff and water temperature and enhanced floodplain habitats.

Methods

In order to define a spatial framework to integrate all the available information, we developed a Virtual Watershed, which included a Synthetic River Network (SRN) coupled to a 25-m digital elevation model (DEM) with the NestStream software (Miller, 2003). The SRN was finally composed by 87417 river stretches, with an average length of 500 m (from 16 to 800 m). Predictor variables describing several environmental attributes (climate, geology, topography, land cover, hydrologic and anthropic) were extracted from existing databases provided by several national and regional organizations and modelled from previous work in the study area (Peñas, 2014; see: <http://ihrivers.ihcantabria.com/>).

Riparian zones were delineated by deriving the geomorphologic floodplain surfaces that best matched the 50-yr flood, following Fernández et al. (2012). The criteria used to obtain those surfaces were 0.75 times the bankfull depth (BFD) for river reaches contained in open and concave valley types and 1.25 times the BFD for river reaches on V-shaped valley types (Fig. 1). Riparian quality was modelled using Random Forest to entire river networks following the modelling framework used in Fernández et al. (2014). This was performed using as a response variable the riparian quality score obtained in more than 150 field sites, while predictor variables were provided by reclassifying the Spanish Land Cover Information System (SIOSE, based in SPOT-5 Satellite images) into 7 land uses.

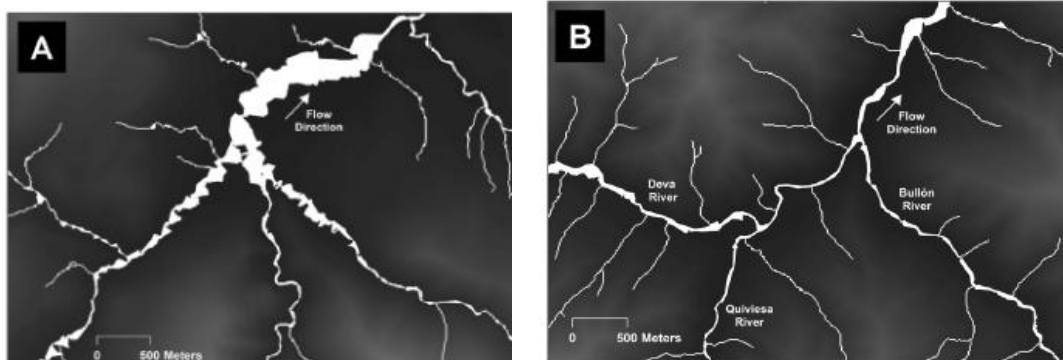

Figure 1. Flood-prone area at 1.25-BFD at a wide flood-prone area (A) and at a narrower flood-prone area (B).

Information on bank profiles, materials and bank erosion were derived from more than 300 river reaches sampled using the River Habitat Survey protocol. The abundance of cliffs on river banks for a given river reach was modelled for the entire river network on our study domain by using this information as a response variable and the attributes from the SRN as the predictors (see: <http://ihrivers.ihcantabria.com/>; Peñas *et al.*, 2014).

The water quality database was developed with information from 4 regional water agencies (Álvarez-Cabria, *et al.*, In Prep.). We compiled information from 1069 sites,

which were sampled from 2003 to 2009. All the variables included in this study (water temperature and nitrate concentration) were modelled with information from sites with data of at least 3 years, representing the seasonal variability of each variable. Finally, we used 297 study sites to develop the water temperature model (174 Atlantic and 123 Mediterranean) and 267 sites for nitrate concentration (196 Atlantic and 81 Mediterranean). Average seasonal (spring, summer, autumn and winter) water temperature and nitrate concentration were modelled for the entire SRN.

Moreover, different geomorphologic floodplain surfaces (1xBFD, 2xBFD and 3xBFD) were delineated for the entire SRN and floodplain extent was compared among them to determine where floodplain extent may be limited by dykes or channelizations versus natural constraints (i.e., valley walls; following Benda *et al.* (2011)).

Finally, the results from all models included in the SRN were used to detect where riparian restoration might have a larger benefit controlling river bank erosion, nitrate runoff, water temperature control and, finally, recovering large extensions of floodplain woodlands.

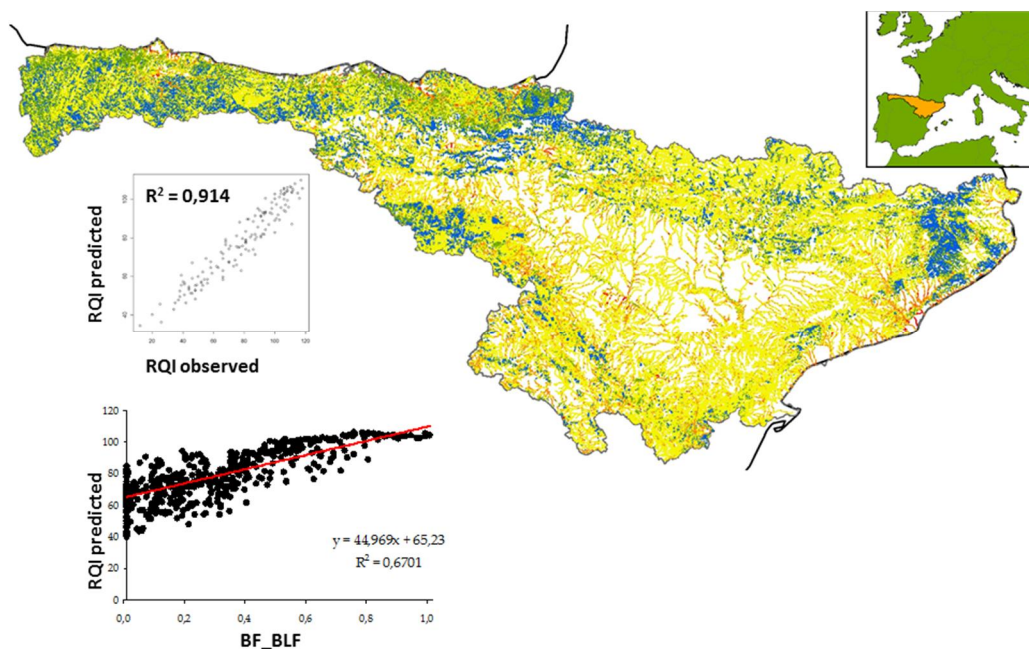

Figure 2. Riparian quality model results obtained using Random Forest in which the riparian quality index (RQI; González del Tánago *et al.*, 2011) was modelled using the land use composition in the riparian zone for the rivers of the northern fourth of the Iberian Peninsula. Univariate relationship between RQI and broad-leaf forest in the riparian zone (BF_BLF) is also shown. This was obtained using the analysis capabilities of synthetic river networks (for more information see: Fernandez *et al.*, 2012 and 2014; red river reaches: very bad conservation status, orange: bad, yellow: moderate, green: good, blue: very good).

Results and conclusions

The delineation of riparian areas was successfully accomplished for entire river networks and riparian quality models using the above protocol achieved good performance (Fig.2). The link between river bank degradation and riparian quality model outputs allowed to link river reach degradation (presence of steep and eroding banks) to different land use

practices that affect riparian corridor quality (less woody vegetation; Fig. 3). This result is of paramount importance for catchment restoration plans in which river reach morphology and riparian areas are usually the objective of many restoration actions, however, often they lack a more focused catchment perspective.

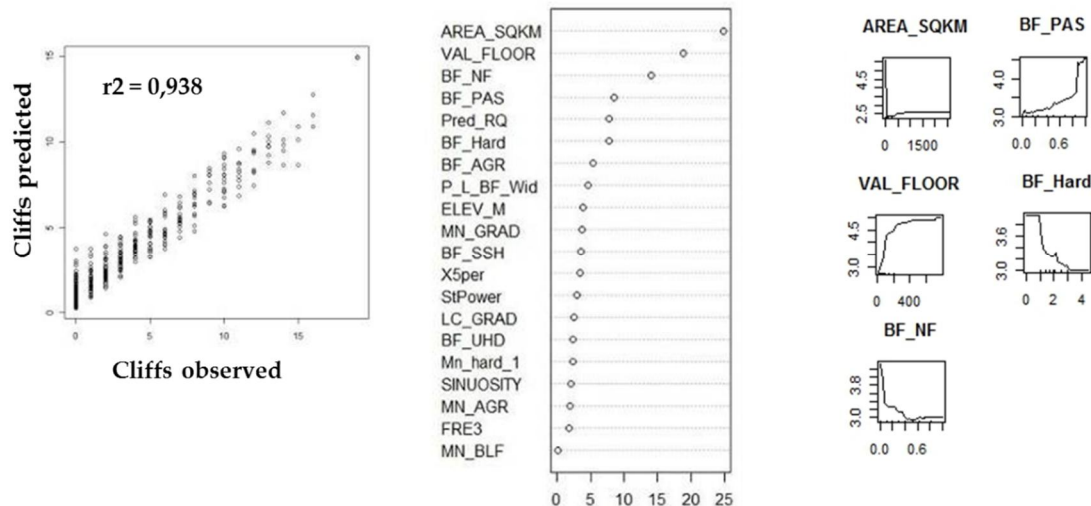

Figure 3. Results obtained by a Random Forest model on cliff abundance on river banks (AREA_SQKM: Catchment area in km²; VAL_FLOOR: Valley Floor Width; BF_NF: Native Forest on a 200m Buffer; BF_PAS: Pasture land on a 200m Buffer; BF_Hard: Substrate hardness on a 200m Buffer; Pred_RQ: Predicted Riparian Quality).

Riparian degradation was also linked to higher nitrate concentration and water temperature (Fig. 4), mainly in agricultural areas where floodplain extent was in many cases also limited by dykes and channelization. Thus, restoring riparian corridors in human-constrained but potentially-wide valleys in river reaches where agricultural development has hardly left any woody vegetation will certainly increase the riparian functionality in these areas. This will help delivering a number of river ecosystem services that are now not being provided nor guaranteed (e.g., water quality, flood control).

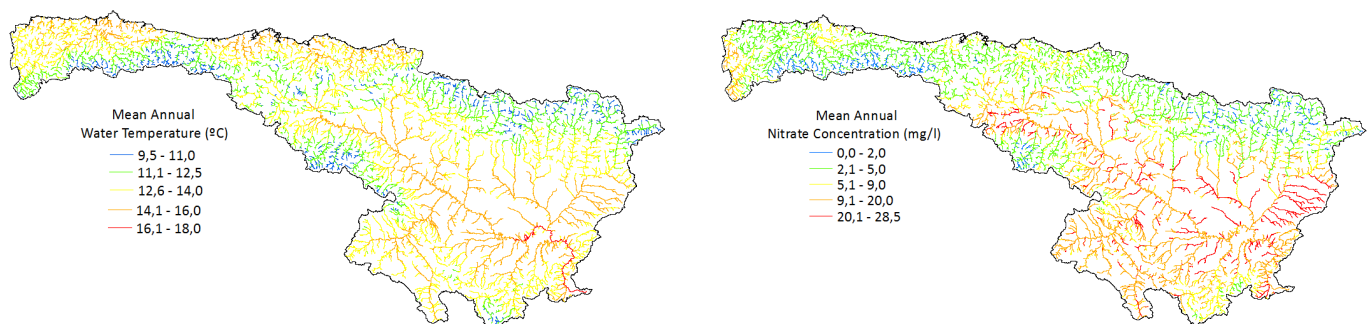

Figure 4. Mean annual water temperature and nitrate concentration obtained using Random Forest models in which more than 250 water quality sites were used in the northern fourth of the Iberian Peninsula (Álvarez-Cabria *et al.*, In Press).

When prioritizing river reaches for restoration by querying our SRN-GIS database including the model results for the riparian quality and the analyzed ecosystem functions, we can see that the selected river reaches are mainly concentrated in two types of

settings (Fig. 5). These are urban and agricultural environments. However, these results could be completely modulated with respect to the needs of different end-users. Moreover, the multicriteria analysis could be highly enhanced by incorporating other spatial or socioeconomic criteria, so that the catchment perspective for river restoration widens up.

This study evidences the need to integrate different ecosystem components and spatial and socioeconomic criteria when planning for river restoration at large spatial scales. Moreover, there is a growing need to perform this integration at a catchment scale, so that river reaches with a larger sensitivity and where environmental benefits are maximized could be prioritized. The delivery of river ecosystem services to human societies and the conservation of river biodiversity could be enhanced if terrestrial and aquatic ecosystem service trade-offs are considered simultaneously.

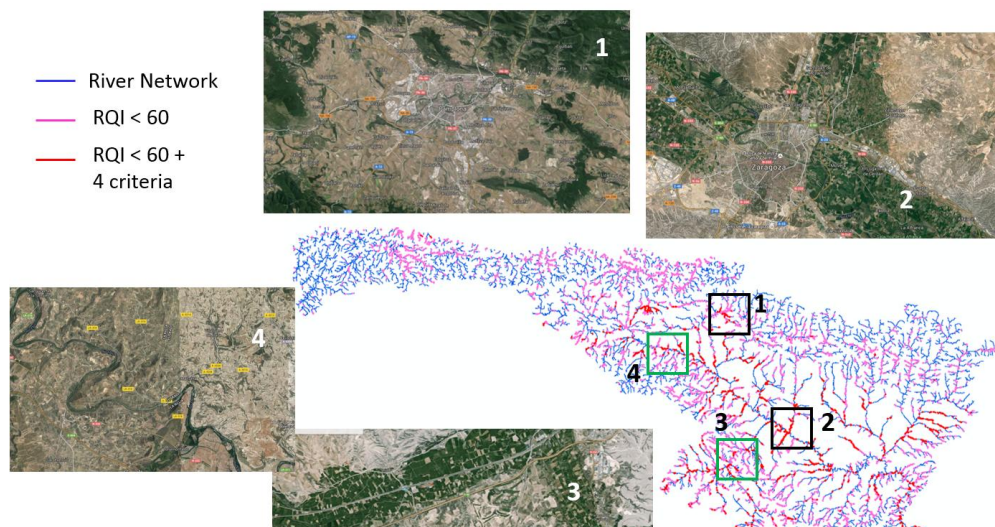

Figure 5. Spatial results after querying a SRN-GIS database for river reaches with bad conservation status for riparian vegetation (RQI < 60: almost 4500 km a 14% of the total river network length), and having a high annual water temperature (> 15°C), high nitrate concentration (>10 mg/l), high bank cliff abundance and high potential for floodplain restoration (> 250 m). These river reaches supposed a 15% (690 km) of the sites with bad riparian vegetation conservation status.

Acknowledgments

This study was partly funded by the Spanish Ministry of Economy and Competitiveness as part of the project MARCE Ref: CTM-2009-07447; <http://marce.ihcantabria.es/>) and the project RIVERLANDS (Ref: BIA2012-33572; <http://riverlands.ihcantabria.es/>). José Barquín is supported by a Ramon y Cajal grant (Ref: RYC-2011-08313) of the Ministry of Economy and Competitiveness.

References

- Álvarez-Cabria, M., Barquín, J. and F. J. Peñas. In Prep. Modelling the spatial and seasonal variability of water quality at large scales. Relationships with natural and anthropic predictors. *The Science of the Total Environment*
- Benda, L., Miller, D. and J. Barquín. 2011. Creating a catchment scale perspective for river restoration. *Hydrology and Earth Systems Sciences* 15:2995–3015.

- Fernández, D., Barquín, J., Álvarez-Cabria, M. and F. J. Peñas. 2012. Quantifying the performance of automated GIS-based geomorphological approaches for riparian zone delineation using digital elevation models. *Hydrology and Earth Systems Sciences* 16:3851–3862.
- Fernández, D., et al. (2014). "Land-use coverage as an indicator of riparian quality." *Ecological Indicators* 41: 165-174.
- Miller, D. 2003. Programs for DEM Analysis. Earth System Institute. Seattle, WA. 38 pp.
- Peñas, F. J., et al. (2014). "The influence of methodological procedures on hydrological classification performance." *Hydrology and Earth Systems Sciences* 18: 3393-3409.

Towards a paradigm change in agri-environmental governance: the concept and practise of locally driven environmental initiatives

Granholm K & Ovaska U

KAJ GRANHOLM

Swedish University of Agricultural Sciences, Grants Office, Box 7071, 75007 Uppsala, Sweden, kaj.granholm@slu.se

ULLA OVASKA

Natural Resources Institute Finland, Latokartanonkaari 9, 00790 Helsinki, Finland, ulla.ovaska@luke.fi

Abstract

The aim of this paper is to discuss the possibilities of a management oriented approach in agri-environmental governance on both the local implementation and administrative levels. The current control driven approach responds poorly to environmental issues on the local scale, as well as on the regional and macro-regional scales. Furthermore, it contributes to the distrust that exists between the agricultural and environmental sectors. The current approach is based on strictly pre-defined actions, whereas more context based solutions would require improved capacity and opportunities for bottom-up local governance approaches. This management oriented approach can be understood as a paradigm change in the way the governance system is viewed. The paper reflects the issue and underlying elements of this paradigm change through case study examples and closes with a stakeholder specific overview of the needed change with respect to relevant policy and management processes.

The four cases from Finland and Sweden studied and highlighted in this paper offer examples of different ways to integrate agricultural production with land and water management, and to utilize the opportunities the general EU CAP framework provides. It is largely up to the will and motivation of individuals, farmers, government officials and advisors alike to make the most of these opportunities. This paper suggests how different local, regional, national and international fora and networks can support local management. Ultimately, as our cases demonstrate, strongly motivated persons can drive initiatives if they have the appropriate support tools and data available. Over time this has the potential to also contribute to adaptations on the system level.

Keywords: agri-environment measures, place-based management, ecosystem based management, bottom-up, water protection

Introduction

The current control oriented approach in agri-environmental governance responds poorly to environmental issues on the local scale, as well as on the regional and macro-regional scales. This is particularly true in policies and measures for better water quality and reduction of nutrient load from agriculture (e.g. EU CoA 2011, Aakkula & Leppänen 2014, Salomon & Sundberg 2012, Berninger et al 2012). Furthermore, the control approach and inefficient responses contribute to the distrust that exists between the agricultural and environmental sectors (e.g. Powell et al 2013). There is a considerable risk, which in

some cases has already materialised, that the current control driven approach will demotivate the responsible, pro-active and environmentally minded farmers and the benefits and synergies from active multi-functional agriculture will be lost (Heinrich & Rammert 2012). This paper attempts to pave way to locally based management of agri-environmental challenges and identify key steps in the process.

This article is based on the report "*More from Agriculture. Testing the concept and practise of locally driven environmental initiatives*" (MTT Report 178) and work carried out in Baltic Compact project. The case projects studied are Järki, Teho Plus and Maisa projects in Finland and the Tullstorp Stream project in Sweden. The work is partly inspired by the examples and experiences from the federal state of Schleswig-Holstein in Germany where university, authorities and farmers demonstrate a new way of cooperation in agri-environmental issues based on the farmers' ideas to develop and manage their local waters and landscapes. These examples are featured in more detail in the above mentioned report and its reference literature.

Results

The research revealed that the success factors of the case-projects were *cooperation, communication, use of local information* and a *coordinator*, and *the adaptive capacity of the administration*. The *funding structures* and *policy frameworks* as such were not seen to contribute to the success of the locally managed bottom-up projects in particular. Successful projects have also contributed to other outcomes than the *objectives* of the projects alone.

Cooperation is the first requirement for many locally managed projects. It appears in different forms: to implement a joint measure or local project administration in a collective way. According to Hagstad (2013), to carry out the correct measures at the right locations and at the right time, farmers' involvement is needed. In order to achieve this, different stakeholders need a common language and assistance from the administration. Cases show that agri-environmental advisory services are important mediators in this aspect. The advisory services have thus far concentrated on single farms, but experiences on group advising have been promising and should be highlighted more in the future. The questions of free-riding had been solved on the local level and were not considered as a problem. It was an issue that had to be tolerated to some extent, but became less significant the more good experience was gained.

In the case studies considered here all the stakeholders learned from each other during the projects which underlines the importance of *communication*. At the start of the projects, in some cases, there were prevailing prejudices against farmers, who were seen to be purposefully neglecting the environment, and similar prejudices held against the administration for collecting detailed information from farms for inspections and sanctions. During the projects these prejudices were broken down through the sharing of information. This affects attitudes and brings the elements of certainty and continuity to the processes being undertaken. In addition to internal communication, it is important to have a communication strategy in order to inform the stakeholders and the wider public about the project in question and its positive effects on the environment. The farmers participating in the projects strongly emphasize the importance of the latter.

The use of *local information* is two-fold. Local people have relevant historical information and should be involved in making general land use plans and planning specific projects. Another factor is the formulation of individual objectives and creation of local mitigation programmes in which the farmers themselves could identify solutions to meet specified targets. Creating an environment in which the farmers can innovate win-win solutions for their business and local community increases mutual trust and cultivates a favourable attitude among the farmers or landowners which is a key to any success in these projects.

It has been suggested that a *coordinator* is needed for locally based projects to facilitate and ease the start and realization of projects (Ljung & Nordström Källström 2013). The purpose of a coordinator would be to take care of the bureaucracy and ensure cooperation and information sharing between stakeholders. In our case studies, coordinators were able to bring continuity to the work, as projects are short but their effects should be long lasting. In addition to overcoming the fear of bureaucracy, coordinators have performed the tasks of ensuring deadlines are met and nothing is forgotten, motivating those involved and working to continue the further development of the process. Thus far the coordinators have been funded by the projects they are involved in, other financing possibilities are hard to find. The expertise and trust between the coordinator and farmer comes from previous successful projects.

In some cases the administration has shown its *adaptive capacity*. Our case studies gave examples of regional level administration providing the possibility to change an application for funding that was not properly made, and promising to be more flexible in certain types of applications. Thus, the role of local level stakeholders is important in building trust among actors and linking individual actions to environmentally effective collective action.

Discussion

The local management approach advocated in this paper follows the theory of ecosystem based management and thus attempts to introduce this theoretical concept in the field of agri-environmental management. Collaborative governance processes and location based management in order to adapt to local contexts (issues, challenges, needs and opportunities) are central in ecosystem based management (Senecah et al. 2006). Local people are the first to notice positive and negative development, and often are those most strongly motivated to improve their living environment. In attempt to advance new management and governance methods, it is important that the ideas are brought up at and discussed within different groups in a meaningful way. Stakeholders need to be able to see their role and the available room for adaptation. The case studies brought to surface a number of fora, formal and informal groups and platforms where discussion on the local management approach to agri-environmental governance can take place.

The success of the case examples featured in this paper relies on individuals acting on a voluntary basis. Therefore, the capacity of the administrative personnel and administrative structures to attend the needs of the local projects is important. Without a doubt, here lies one of the biggest challenges in adopting more locally based approach in agri-environmental management. How should the administration adapt to place-based measures derived from the local needs and at the same time ensure fulfilment of legal obligations, principles of equality and objectivity and sector objectives on the national

level? The answer we want to put forth is not that we should look so much in to the design of policies and administrative structures, but to ease the daily interaction, communication and information exchange between people in the administration and promote cross-sector considerations.

According to a recent study in the Baltic Sea Region, the River Basin Management Plans and the planning process have not succeeded in reaching the farmers (Sall et al. 2012). Farmers could potentially have a bigger role in the process, but are currently relatively isolated from the process. The planning process should better consider local targets and feasibility within land use planning, as well as the role of farmers as land managers. Farmers and agricultural sector could be better involved in the process both through organizing their engagement on the local-level and by better dialogue and coordination between environmental and agricultural administrations. On the European level, there is also a need to pay attention to how the WFD requirements are defined, taking into account greening and cross-compliance measures so that the associated RDP article can be effectively used (see e.g. Polakova et al. 2013). The WFD also gives consideration to hydro-morphological pressures and changes in the stream network, but further attention needs to be given to managing these changes, and possible benefits as nutrient load mitigation measures in coordination with purely agricultural measures. If the work on river basin level would take water flows into account more, it could create room to realize positive synergies between agricultural water use and drainage systems, and water quality and needs for ecosystem services on the catchment scale. Land use plans and planning conflicts between basin authorities and the local level need to be addressed and accommodate both local and basin level objectives. Thus, a balanced approach with an adequate role for the local level (bottom-up) is needed also in river basin planning. On the local scale, permit processes for drainage interventions or ditch restoration provide an opportunity to bring all concerned landowners together and discuss objectives and possibilities in a constructive and proactive way, instead of merely concluding whether a proposed project is harmful to the environment.

The featured cases do not offer nor suggest a comprehensive workable solution on the governance system or policy level to adopt a more locally lead management approach, nor do they allow us to draw complete guidelines on how the administrative structures and policies should be designed. However, they confidently support the conclusion that motivated individuals, on the ground and in the administration can promote this approach in interaction with local level actors and influence the systemic change through facilitating the emergence of good examples.

Conclusions

This paper has proposed a new way in which to perceive agri-environmental governance, a view which attempts to better incorporate the multiple needs of the entrepreneur and the stakeholders involved and to bring about environmental benefits for the society. Through case examples it revealed that the local stakeholders are keen to try this and assume more responsibility, and that it is largely through individual motivation and effort that projects succeed. Formal structures and institutional mechanisms or policies had a relatively small role in boosting local action and bringing together the stakeholders which suggest the significance of local communication. It is through this way, from bottom-up, that the systems can be changed.

The case studies confidently show the power of individual motivation and drive which can make things happen regardless of obstacles, or handicaps in the system, formal structures or policies. There are farmers out there who understand the value of what they can contribute to the society and have the motivation to take action for their local environment (e.g. Hagstad 2013). The cases, as well as other experience, show that informal institutions can contribute to increase personal motivation of key actors which in turn can lead to the necessary changes in formal institutions. The role of routine working interactions between people in opening the pathways must not be overlooked. Better communication – on all levels, when it is open, honest, transparent and continuous – is the key to success.

References

- Aakkula J. & Leppänen J. (eds.) (2014): Maatalouden ympäristötuen vaikuttavuuden seurantatutkimus (MYTVAS-3) - loppuraportti.
- Berninger K., J. Koskiahho, S. Tattari (2012): Constructed wetlands in Finnish agricultural environments: Balancing between effective water protection and multi-functionality. Baltic Compass Project Report.
- EU CoA (2011): *Is agri-environment support well designed and managed*. EU Court of Auditors Special report 7/2011.
- Hagstad, E. (2013): Opportunities and obstacles to local collaboration in water management in order to introduce water protection measures in agriculture. Master Thesis. University of Hohenheim. Institute of Landscape and Plant Ecology.
- Heeb, A. & Johansson L. (2012): Buffer Zones & Wetlands as Agri-Environmental Measures in the Baltic Sea Region. Discussion paper for the fourth HELCOM Agri-Environmental Forum, October 2012.
- Heinrich C. & Rammert U. (2012): Case Study Schleswig-Holstein: Improving bottom-up project communication and acceptance. Baltic Compass project report.
- Interviews with participants of Järki, Maisa, Teho Plus and Tullstorp Stream projects. 2014. Notes with the authors.
- Ljung, M. & Nordström Källström, H. (2013): Miljöätgärder i samverkan-strategier för att inspirera till miljöätgärder i jordbruket. Jordbruksverkets rapport 2013: 31.
- Ovaska, U. & Granholm, K. (2014): More from Agriculture. Testing the concept and practise of locally driven environmental initiatives. MTT Raportti 178.
- Poláková, J, S. Berman, S. Nauman, A. Frelih-Larsen, J. von Togenburg, A. Farmer (2013) 'Sustainable management of natural resources with a focus on water and agriculture'. Report Prepared for the STOA Panel of the European Parliament.
- Powell N., M. Osbeck, R. K. Larsen, K. Andersson, G. Schwartz & M. Davis (2012): The Common Agricultural Policy post-2013: a Pathway to Regional Cohesion? - Lessons Learned in Implementing Agri-Environmental Measures in the Baltic Sea Region. Baltic Compass project report.
- Rogers, P. P., K. F. Jalal, J. A. Boyd (2008): *An Introduction to Sustainable Development*. Earthscan.
- Sall, M.; K. Peterson, P. Kuldna, H. Nilsson, S. Väisänen, S. Tattari, K. Berninger, M. Larsson, P. Wallenberg, J. Buzelyte, S. Tyszewski, D. Puśłowska-Tyszewska, M. Przychodzka (2012): The Role of River Basin Management Plans in addressing water pollution from agriculture to limit the eutrophication of the Baltic Sea. Summary Report comparing five Baltic Sea riparian countries. Baltic COMPASS project. SEI Tallinn.
- Salomon, E. & Sundberg M., eds. (2012): Implementation and status of priority measures to reduce nitrogen and phosphorus leakage – Summary of Country Reports. Baltic Compass project report.
- SBA, Swedish Board of Agriculture (2013): How can the Rural Development Programme's agri-environmental payments be improved? – Experiences from other countries. Swedish Board of Agriculture report 2013:21.
- Senecah S.; J. Manno, W. Wise, D. Conover (2006): Ecosystem-based Management in New York State: Taking the Next Steps. Summary Report to the New York Ocean and Great Lakes Ecosystem Conservation Council. December 2006. Page 5.

Integrated evaluation to support river restoration: a simple, but effective decision making framework applied to the Chiese River (Italy).

Nardini A & Pavan S

ANDREA NARDINI & SARA PAVAN

*CIRF - Centro Italiano per la Riqualificazione Fluviale
Viale Garibaldi, 44/a - 30173 Mestre (Venezia) – Italy.*

Introduction

There is a tendency to consider multiple benefits related to River Restoration (RR) projects, including the environmental services delivered. In particular, demonstrating that rivers in a more natural status are not only desirable for the sake of nature conservation, but also or mainly because they can deploy the most effective, economically-efficient and robust way to combat flood risk, is key. Several attempts are being performed to assess in economic terms such services. When not quantified, they remain unverifiable statements; when monetized, however, questionable hypothesis are generally introduced which weaken the argumentations. Moreover, the economic approach is not suited to address the explicit interests of relevant stakeholders and their diverging views or conflicting objectives which are perhaps the driving force of real decision making. As a result, we have weaker arguments to support RR projects and less restoration is obtained. A significant step forward can be done if we succeed to demonstrate, through *a priori* and *a posteriori* evaluation, that advantages offset the (inevitable) drawbacks in a wider framework than that of Cost Benefit Analysis.

Here we propose an approach articulated on three levels that spontaneously stems from the evolution of the traditional approach to flood risk management and fulfills a number of key requirements; namely: i) recognizing the multiobjective nature of the decision making problem; ii) linking the effects to the stated objectives (which implies a serious issue of measuring and clear criteria for monitoring after implementation); iii) supporting a negotiation process to manage interest conflicts amongst stakeholders; iv) being simple, understandable by the layman and applicable; v) integrating the main approaches adopted to support evaluation: Environmental Impact Assessment (EIA), Cost Benefit Analysis (CBA) and Multicriteria Analysis (MCA). The approach is similar to the one adopted in Frans et al. (2004) with some differences; namely, here we: i) organize the process in three levels to fulfill the main point of views: objective assessment, subjective stakeholders' perception, strategic decision making; ii) identify and quantify few clear key objectives (with no claim that they are the only ones, but certainly the core ones); iii) adopt the multi-attribute value function approach to measure stakeholders' satisfaction through suitable evaluation indices (not shown however in this application); iv) show how to embed CBA within a broader MCA framework. Nardini and Pavan (2012b) already published a paper with the original findings on Journal of Flood Risk Management; here we propose a slightly different version intended to make the approach more understandable to the broader public.

Methodology

Only the evaluation phase of a participatory decision making process aiming at designing and choosing a river setting alternative is discussed here for reasons of space. This phase can be articulated in three stages as follows:

Stage i) technical evaluation: This is a “what-if” exercise where the key objectives N: Nature conservation (or improvement of ecosystem status), R: Risk reduction, C: total Costs minimization, S: Socio-economic disturbance minimization (and possibly others), corresponding to each ALternative, are measured as objectively as possible.

Stage ii) conflict management evaluation: Here the idea is to articulate the constituting objectives according to all stakeholders' views. It is the pivot around which to develop an open discussion and negotiation amongst them and decision makers. Here the concern is quality of life or, more practically, the satisfaction of each stakeholder, according to his own sensitivity and values. The indices utilized here are conceptually different from those of Stage i), because here the aim is to represent stakeholders' satisfaction exactly as they perceive it; hence, for instance, risk can be split in several items as perceived risk can be different from objective risk (expected value of damages) possibly because the subject is strongly risk averse (and hence the Utility Function concept is the appropriate tool);

Stage iii) Overall public decision making, or strategic evaluation: Here the spirit is to compare general pros and cons, which can be classified in two classes: a) *Quality of Life (QoL)* strictly speaking including a summary of the perceived satisfaction of stakeholders more directly involved (Stage ii), additional components of the multiattribute risk objective not captured by its technical-economic formulation (e.g. health and psychological effects, or possible lives loss), together with all that is required to achieve and reach and maintain such a QoL level -like financial feasibility and sustainability- and proxies of the “QoL of the outer world”; b) *“justice”*: e.g. fairness in the allocation of pros and cons amongst different areas/subjects, as well as environmental sustainability in strict sense for the sake of an ethic of nature and of future generations (maintenance of a natural capital, which is where the WFD is reflected through the index N for the ecological status), and so on.

Notice that a key item in the “quality of life of the outer world” refers to the effects (externalities) that the management choices in the considered river basin may export outside, and particularly to the downstream main river basin. In the context of flood risk and river restoration, the main consequences are associated with:

- export of higher or lower flood peaks (and their timing)
- alteration of solid flow exported downstream.

Also others may count, like the export of contaminant/nutrient loads downstream or the impact on fish-stock reproduction because of physical barriers; etc. Quantifying these aspects is quite difficult, but ignoring them would be a mistake. Hence, at least, they should just be reminded and assessed in qualitative terms.

A powerful partial proxy of the “QoL of the inner and outer world” is provided by the social net benefit B_N determined through an Extended Cost-Benefit Analysis (ECBA) because, according to welfare theory (Dasgupta and Pearce 1978), choosing decisions which maximize B_N implies producing efficiently (with no wastage) and allocating products according to consumers' preferences, which is assumed to make them better off. B_N cannot substitute all other criteria, but it is a powerful synthesis of part of them and an index to which decision makers are very well used and sensitive. It is particularly

meaningful when presented in association with additional indices measuring the components of value not explicitly included.

Case study on the Chiese river (Italy)

A very short summary is presented here; the reader is invited to read the original paper Nardini and Pavan (2012a) for details. It must be pointed out that the evaluation is simplified with respect to the methodological framework presented and, in particular, Stage ii), although extremely important to reach feasibility, was not carried out.

The system and the key solution ALTERNATIVES

The methodology was applied to the whole 80 km stretch of Chiese River downstream of lake Idro (one of the piedmont post glacial natural, but partially regulated lakes of northern Italy), until its confluence with river Oglio. Almost all its course is highly artificialized with several big size weirs and longitudinal defenses, and big, sometimes multiple levees.

Three river setting ALTERNATIVES were truly developed in full (but some analysis steps were carried out for the other ones as well):

- *ALT_0*: the "business as usual" alternative, which implies high OMR costs for keeping the current defense and exploitation works system and some pointwise, urgent interventions that were considered mandatory by AdBPo (the Po River basin Authority).
- *ALT_SdF*: representing the solution proposed in AdBPo (2004) which basically spouses the classic engineering *Approach a*) of putting in safe conditions the river corridor (where land use is other than just unexploited, natural areas) with respect to the 200 recurrence time T_R flood $Q_{T_R=200}$
- *ALT_Base**: this is a first trial of restoration which implements the criterion of eliminating as many works as possible while keeping the impact on the anthropogenic system as low as possible. Let us say it is a "prudent" strategy, because it makes a step toward improving the ecological status, but without much glamour, as it just tries to increase efficiency through savings.

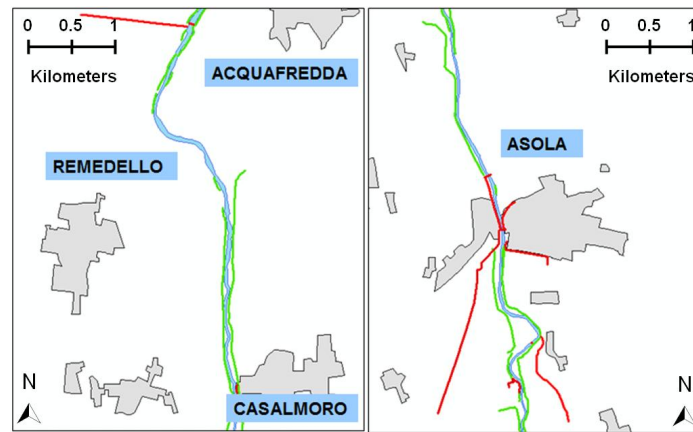

Figure 1. Two reaches of the Chiese River in the ALT_Base* (left: reach downstream of Acquafredda town; right: following downstream reach). The green lines indicate currently existing works that would be dismissed in such an alternative, while the red ones indicate works (existing or planned by SdF or newly proposed by us) which would be kept in ALT_Base*.

Stage i) Technical evaluation

A detailed description of the evaluation indices adopted is presented in Nardini and Pavan, 2012b. As several indices are commensurable (monetary units), it is possible to plot on a bi-dimensional plan the Multiobjective performance of the ALTERNatives. We just sum up all indices spontaneously evaluated in economic-monetary terms (OMR savings from dismissed works, investment of new ones, differential flood and hydro-morphological risk, value gains or losses because of land-use changes) in a single index on the horizontal axis, while the fluvial ecosystem status (qualitative index N) is represented on the vertical axis:

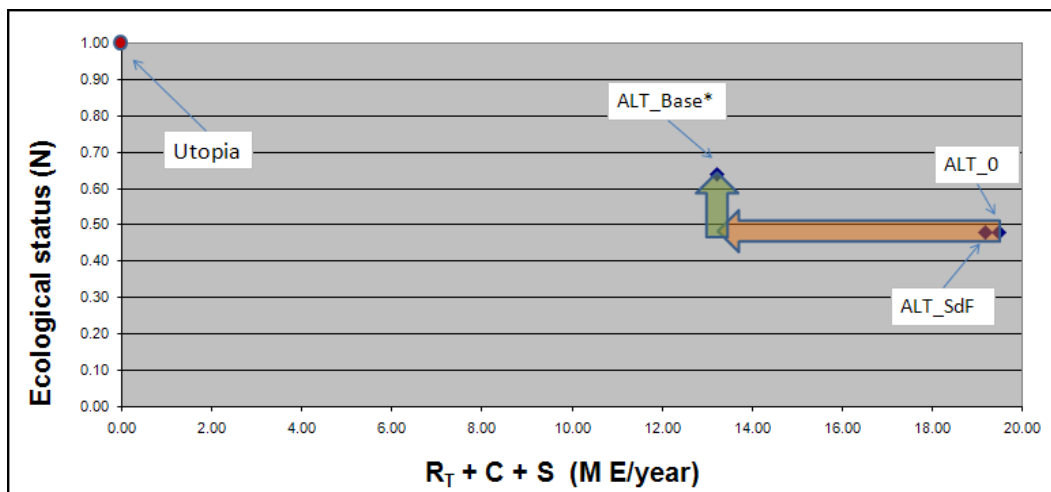

Figure 2. Multiobjective technical evaluation: total equivalent expenditure (R_T : flooding RTF plus hydro-morphological risk R_M ; C : total cost of works, including capitalized OMR; S : Social disturbance which, in our case, reduces to just land-use change in an irrigation district) on the horizontal axis; ecosystem status N index on the vertical axis (proxy of the WFD ecological status). "Utopia" point corresponds to the ideal, unreachable situation where there are no expenditures, while the ecosystem status is perfect.

Table 1: Summary of *Approach d) "multiobjective (QoL)", Stage iii) strategic evaluation*. ALT_Base^* increases, as expected, the hydraulic (flooding) and morphological (bank erosion and channel migration) risk components, as well as (slightly) the social impact (S). It clearly performs better, however, with regard to all other aspects. "Fragility" (the likelihood of works failure), "Externalities" and "ecosystem status" are qualitative indices.

				ALT_0	ALT_SdF	ALT_Base^*
QoL stakeholders	$R_T^F + R_M$	total Risk (hydraulic R_T^F + morphological R_M)	ME/year	2.52	2.11	3.30
	$R_{failure}^F$	fragility (residual risk due to likely failures)	-	2.06	1.68	0.85
	$S_{agro-sett.}$	Social disturbance: land-value loss	ME/year		0.00	0.07
	$S_{water\ use}$	Social disturbance: hydropower loss	ME/year		0.00	0.00
QoL outer	C	financial sustainability: total Cost (investment + OMR)	ME/year	16.95	17.05	9.83
	B_N	economic efficiency: net Benefit	ME/year		0.33	6.35
		externalities out of basin	-	3 peak reduction 1 solid flow	1 peak reduction 0 solid flow	3 peak reduction 3 solid flow
Justice	N	Nature conservation (ecosystem status)	-	0.48	0.48	0.64

The evaluation of the single economic items (presented in the next paragraph) reveals that ALT_Base^* , i.e. smooth restoration, dominates both ALT_0 , and ALT_SdF (which show very similar performances); in other words, ALT_Base^* implies lower total expenditures (moves to the left), while improving "Nature" (moves upward, towards the Utopia point U)!

Stage iii) Strategic evaluation

Here a quite simplified attempt to implement *Stage iii* discussed in the Methodology section is presented in relation to our case study. Measures already obtained for total (R_T) and residual ($R_{failure}$) risks, and Social disturbance (S) are used -instead of the subjective satisfaction indices (QoL) to be obtained from *Stage ii) conflict management evaluation* (not developed in this research). For the *Outer world's QoL* component, we considered a proxy, rough measure of net social benefit, i.e. the same index B_N already calculated (because it resumes how well objectives are reached, compared to the effort required), aside with the required expenses C to be beared by the whole community; also qualitative "measures" of key effects exported outside from our basin are included in this component. No explicit measure representing *Justice* component is developed; however, the ecological status index N is here considered as representative of nature conservation issues. This latter perspective (resumed in Table 1) clearly shows that ALT_Base^* increments both total risk (hydraulic R_T^F component plus morphological R^M component) and marginally the disturbance S (the agro-setting component $S_{agro-sett.}$), but significantly reduces the residual risk ($R_{failure}^F$); moreover, CBA result (B_N) tells us that there is a powerful net gain which benefits the whole community as, indeed, there is a significant reduction of total cost C (investment + OMR of existing and new works: from about 17 to about 10 only). Furthermore, there are additional benefits in terms of

positive externalities (rough, subjective, qualitative indication where 3 is the best and 0 the worst score): i) fewer defense works in Chiese basin imply more overflows in it and hence a (small?) reduction of flood peak exported downstream (a benefit!); ii) again, fewer longitudinal defenses imply an increment of solid input from bank erosion and hence a (slightly?) increased solid flow exported downstream (again a benefit, as the rest of the river network is strongly sediment starving). Finally, in *ALT_Base** the ecological status is significantly improved.

Conclusions

Results show that *ALT_Base** is in principle a very attractive solution both from an objective point of view (Stage i) and from a strategic perspective (Stage iii) as it performs by far the highest economic efficiency (lowers works costs, although it rises a bit -but much less- expected damages) and offers additional non economically-quantified benefits (externalities and nature conservation). However, it may be politically hard to be accepted because some stakeholders would end worse than they would in the business as usual solution (*ALT_0*): they would experience a bit more frequent flood damages; progressive land loss of a given area because of erosion, some production loss from no longer irrigated agricultural areas (because a withdrawal dike crest should be lowered to reduce flooding).

To make *ALT_Base** an implementable solution, the problem becomes one of how translating the net benefit in a solution socially acceptable or desirable. Apart increasing people awareness, perhaps the simplest actions would be: i) purchasing the land affected by morpho dynamics (erosion); ii) payment of environmental service (TEEB, 2009) provided by those who would bear the negative consequences (more frequent flooding, loss of agricultural production), while re-directing land-use to more compatible activities (e.g. multiple aim forestation, including CO₂ fixing and biomasses for energy generation, rather than traditional mono-crop agriculture); iii) applying a mandatory or voluntary insurance coverage, capable to respond operationally and able to differentiate the various areas according to hazard (all accompanied by a policy to encourage people in the wrong places to move out, but supported by a solidarity mechanism for those who have no other chances or who were not sufficiently informed when they settled, etc.). Some of these measures may be costly, but they can be totally or partially covered by the future savings of OMR costs of dismissed works. This type of issue is exactly the one that Stage ii) *conflict management evaluation*, is intended to support. The idea is that through this evaluation, planners –supported by skilled analysts- be able to identify ALTERNatives that, in the end, leave affected stakeholders in a better-off condition (win-win solutions) according to their own subjective judgment, or at least with the convincement that the chosen one is a fair option (Keeney, 1992).

Although the Chiese case study cannot be generalized "tout court", and it suffers from limitations of analysis, it shows the very high potential of the proposed methodology to support a structured, transparent decision making process where the different needs accruing to the myth of integrated river basin management can be actually merged, so providing a real tool to merge several EU Directives: Flood, Water Framework, Habitat, amongst others.

References

AdBPo (2004). "Studio di Fattibilità della Sistemazione Idraulica del fiume Oglio nel tratto da Sonico alla confluenza in Po e del suo affluente Cherio dal lago di Endine alla confluenza; del fiume Mella da Brozzo alla confluenza in Oglio, del fiume Garza dalla confluenza Valle del Loc alla

- confluenza in Chiese e del fiume Chiese da Gavardo alla confluenza in Oglio" (Feasibility study of the hydraulic setting of river Oglio in the reach from Sonico to the outlet into Po River, and of its tributary Cherio from Lake Endine to the outlet; of River Mella from Brozzo to the outlet into Oglio, of River Garza from Valle del Loc to the outlet into Chiese, and of River Chiese from Gavardo to the outlet into Oglio). Autorità di bacino del Po. Parma (in Italian). (Feasibility Study, in the text indicated as "SdF")
- Dasgupta, A.K., and Pearce, D.W. (1978). *Cost-Benefit Analysis: Theory and Practice*. MacMillan, London.
- Frans, K., van Buuren, M., van Rooij, S.A.M., 2004. Flood-risk management strategies for uncertain future: living with Rhine river floods in the Netherlands. *AMBIO*, 33 (3): 141-147.
- Keeney, R. (1992). *Value Focused Thinking*. Harvard University Press, Cambridge, Massachusetts.
- Nardini A. and Pavan S., (2012). River restoration: not only for the sake of nature, but also for saving money while addressing flood risk. A decision making framework applied to the Chiese River (Po basin-Italy), *Journal of Flood Risk Management*, 5 (2012) 111–133
- TEEB (2009). *The Economics of Ecosystems and Biodiversity for National and International Policy Makers*. UNEP. Taylor & Francis Group, Oxford.

Strategic river management in Styria/Austria - Establishing trade-offs between hydropower expansion and river rehabilitation

Raderbauer H et al.

HANS-JÖRG RADERBAUER, CHRISTINE KONRADI, THEODOR WIMMER
Freiland Environmental Consulting Civil Engineers LLC, Liechtensteinstraße 63,
Vienna, 1090, Austria

Austrian rivers and especially those with high energy potential are exposed to increased pressure due to hydropower expansion plans. This development endangers the efforts for ecological river restoration taken in the past years. It was therefore necessary to find new forms of river management, consolidating the future use of the water resources with all stakeholders. The Styrian department for water management, resources and sustainability was the first in all Austrian provinces to address the challenge of balancing various user interests and diverging targets of EU directives.

In contrast to other alpine river catchment areas, some sections along rivers in Styria are still in a good ecological state and offer free-flowing zones. Additionally many stretches have been restored by large-scale EU-funded river restoration projects since 1995. In accordance with the objectives set by the Habitats Directive (92/43 EEC) and the EU Water Framework Directive (2000/60/EC; WFD), considerable efforts have been taken along the upper River Mur (~90 km stretch of river), the boarder section of the River Mur (~32 km) and the River Enns (~50 km) to secure biodiversity, enable dynamic river development and enhance passive flood protection. The new EU programming period concerning environmental protection projects starts in 2015, but the participation of the Styrian State is increasingly questioned due to the contradictory objectives of large-scale river restoration and the increased renewable energy production.

To attain a rational compromise on diverging public interests regarding water resources, water management plans (German: *Gewässerbewirtschaftungspläne*, BWP) were developed for the major Styrian rivers Enns, Mur and Mürz. These plans aim to define the framework conditions for new hydropower plants, without interfering with the objectives of the WFD and the Habitats directive.

Introduction

Energy production in Austria

Austria, as an alpine country, provides favorable conditions for hydropower use. Hydropower plants contribute two thirds of the annual energy generation. The main aim of the EU Renewable Energy Directive (2009/28/EC; RED) is to increase the share of renewable energy production until 2020. Austria committed to further increasing the amount of renewable energy in its gross final consumption from 31 % (2011) to 34 % in 2020. The Austrian provinces differ in their contribution to reach the national goal depending on their potential for hydropower production. A sixth (2.100 GWh/a) of the total remaining hydropower potential for Austria is allocated to Styria (1). Hence, the construction of new hydropower plants is necessary to reach the energy goals.

River stretches with ecological significance, nature conservation areas

Long stretches of the upper River Mur are part of the Natura 2000 network, protecting river habitats and species as for example the rare Danube salmon (*Hucho hucho*), which is especially sensitive to hydropower developments. Another important Natura 2000 area is situated along the border stretch of the river Mur, protecting the second biggest floodplain forest in Austria. Along the river Enns three Natura 2000 areas exist that protect the ecologically largely intact river and its habitats.

Co-financed by the EU-funding programs LIFE, Interreg IIIa and ETZ SI-AT, large-scale river restoration projects have been initiated in the above mentioned nature protection sites in order to protect biodiversity enable dynamic river development and enhance passive flood protection.

Planning instruments

The advanced degree of hydropower development is highly significant for reaching the imposed energy and climate goals, but at the same time it is an intrinsic cause for the dissatisfying ecological state of water bodies in Austria (2). The goals of the energy sector endanger ecologically intact river stretches and partly contradict the aims of the legally protected Natura 2000 areas, mainly in terms of the aquatic environment. Further conflicts arise in respect to the Habitats directive (demand for wildlife and nature conservation) as well as the WFD (obligation to achieve a good ecological status/potential for all rivers). The importance of rivers for recreational and touristic use, further contributes to the conflicting public goals in river use.

To reconcile those conflicting interests, especially on regional level, the presently available instruments, as the National River Basin Management Plan (3, *NRBMP*) and the Austrian Water Act, have been insufficient. Consequently, it is necessary to balance water management with suitable planning instruments that are applicable at different spatial levels.

To reach a broad consensus between the stakeholders' interests and to balance use and protection of the rivers, the Styrian state and the main energy service companies (Verbund Hydropower AG, Energie Steiermark Green Power AG, Envesta) initiated a new planning instrument, the river basin management plans (*BWP*).

Content and goals

Main aim of the BWP is to define framework conditions for future hydropower development, without contradicting the targets of the WFD or harming protected areas. The core element of the BWP is the specification of future use and protection of river stretches, respectively. Concerning contents, the BWP are in line with the NRBMP and the Austrian Water Act, including the following:

- *Environmental basis:* A general description of the characteristics of the river catchment unit as well as an overview of the significant pressures and anthropogenic impacts influencing the state of the water course.
- *Deficit analysis:* A comprehensive analysis of ecological deficits, serving as basis for the development of measures.
- *Proposals for measures:* Defining feasible mitigation measures in order to improve the environmental conditions and to reach environmental targets.

- *Designation of river stretches:* Specification of river stretches for future hydropower development and nature protection.

Methods

Process description

Freiland Environmental Consulting Civil Engineers Ltd. was assigned with the development of the BWP and the coordination of the accompanying stakeholder involvement process. The project area encompasses the Styrian sections of the rivers Enns, Mur and Mürz (in total 512 river kilometers), which are all part of the international river basin Danube. The basic units for the project, 33 single water bodies, were defined in accordance with the NRBMP.

The accompanying stakeholder involvement process was initiated involving the most relevant energy supply companies and representatives of the Styrian State. Regular workshops enabled continuous coordination and management of work packages.

Environmental basis

Based on the comprehensive analyses of existing information, detailed profiles of the water bodies were created. These include information on environmental characteristics anthropogenic pressures, protected areas and ecological deficits

Deficit analysis

As part of the process of the BWP a deficit analysis was conducted. On the one hand the pressures already identified in the NRBMP were revised, while on the other hand aspects such as riparian vegetation and potential for development were assessed by satellite imagery analysis. Thus, a thorough assessment of the realization options of measures is provided, which can be used as an information basis for river restoration.

Proposals for measures

For every water body with ecological deficits, measures are proposed based on the deficit analyses. They are kept fairly general, neither a precise location nor detailed plans were elaborated, but basic possibilities of effective rehabilitation are demonstrated.

Designation of river stretches

In a first step, definitions for the classification of river sections were developed in close coordination between the project participants. The following classifications for river sections were agreed on:

Ecological priority zones: Environmentally sensitive water bodies worthy of protection. The preservation and improvement of the ecological state has priority over the interests of energy use. Hence hydropower development is not possible.

Trade-off zones: This definition applies to stretches of rivers of high ecological value with high hydropower potentials. Hydropower development is only possible if no ecological deterioration is caused, meaning that alterations are only permissible within a so called "state class" (as designated by the NRBMP). Hydropower developers therefore have to liaise closely with ecologists in order to develop compatible solutions.

Zones of no particular designation: River sections without specific ecological sensitivity or hydropower potential remain without designation in the BWP. In many cases these sections are already used for the generation of electricity.

In a second step, criteria for the designation of the aforementioned river sections were defined among the project participants and stakeholders.

Proposals for the protection of river sections of special ecological importance (4): Based on the criteria set in the NRBMP, this study designates rivers stretches with high ecological importance for all water bodies in Styria.

Current ecological state: Hydropower plants cause alterations in the river characteristics and often lead to deterioration of the ecological state. Each class has different thresholds concerning deterioration, thus the chances to attain permits for hydropower developments vary depending on the current status.

Implemented measures for ecological improvement: It was an important aspect to consider already implemented measures for ecological improvement and rehabilitation that had been publicly funded. In order not to counteract those efforts, most of the respective river sections were considered as ecological priority zones.

Nature conservation areas - legal compliance: For determining if hydropower development in nature conservation areas is possible, an assessment of the legal compatibility (regarding protection goals and protected species) was conducted pursuant to the Styrian Nature Conservation Act.

Nature conservation areas - sensitivity assessment of protected species and habitats: As a second step concerning river-bound nature conservation areas, an assessment of the sensitivity was carried out. Basically, the distinction between high, medium and low sensitivity was introduced, depending on the presence of protected habitats and species. Generally it was assumed, that for sections with medium sensitivity certain types of hydropower plants are acceptable assuming ecologically sound planning. Sections of high sensitivity were classified as ecological priority zones.

Expansion of energy production corresponding to energy target programs: Due to legal requirements there is an obligation for increasing the renewable energy production. According to the Climate Protection Plan of Styria (5) an expansion of 670 GWh/a generated by hydropower plants is foreseen (from 2008-2020). Although some large hydropower projects were realized since 2008, there is still a gap of 322 GWh/a between target and actual energy production. The contributions of small scale hydropower plants were considered to be marginal, therefore all project participants agreed on the requirement of designating river sections for hydropower development with a minimum potential of 322 GWh/a.

Investigation of the hydropower potential for Styria (6): The main aim of this study conducted by the Energie Steiermark Green Power AG was to determine the technically feasible, unused and remaining potentials of Styrian rivers. For gaining results that are realistic in terms of their realization, also ecological criteria were included. In the end

eleven sections of the rivers Enns and Mur were identified as suitable both in terms of hydropower potential and ecological basis.

Results

All criteria were made spatially visible and evaluated using GIS software. Every river stretch was discussed by the project participants. The focus was set on reaching a consensual decision on the designation of stretches, always taking into account the participants priorities, nature conservation- and river restoration aspects as well as energy policy goals. The final result was the designation of 33 river stretches (Figure 1).

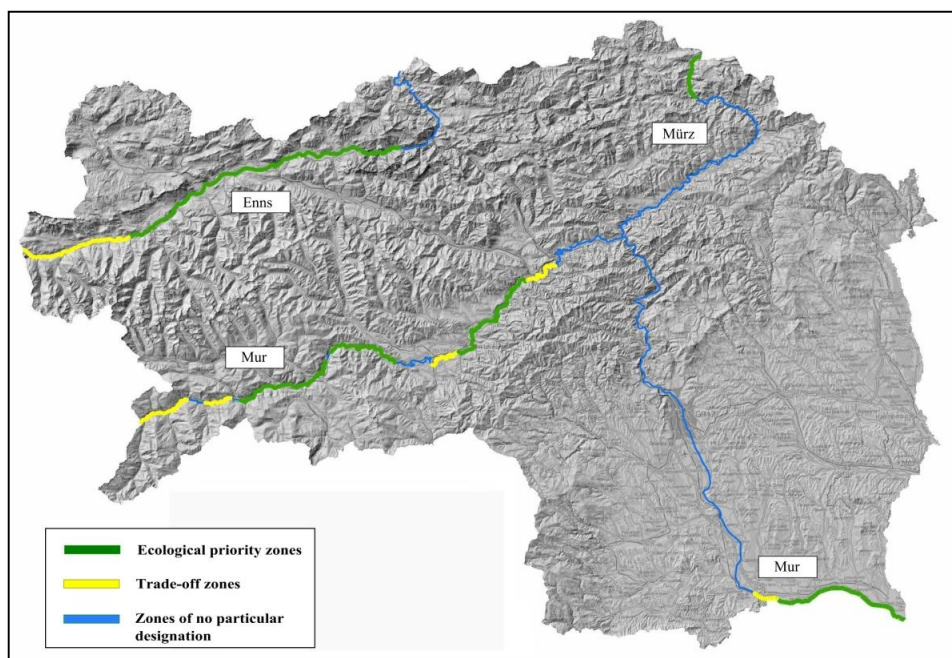

Figure 1. Final result designation process for the rivers Enns, Mur, Mürz.

In total 50 % (255 km) of the river stretches were designated as “ecological priority zone” or “trade-off zone” and are therewith protected against further degradation to an inferior ecological state class (according to the NRBMP). In longer free-flowing sections, new hydropower plants are only allowed at the fringes (therefore defined as “trade-off zones”). The central parts of the free-flowing sections often overlap with designated Natura 2000 areas and are therefore classified as “ecological priority zones”.

The other 50% of the river courses stay without designation due to their initial level of pollution and prior impacts. This mainly applies to sections with already existing hydropower use and low levels of residual energy potential.

The specifications set out in the BWP will contribute to reaching the 2020 energy policy targets. Within the “trade-off zones” energy potentials of up to 540 GWh/a remain available.

Conclusions

The BWP and its development process have contributed substantially to reaching a rational consensus and a solution for the conflicting public interests, in particular environmental protection and expansion of renewable energy production. The designation of specific river sections along the three major Styrian rivers Enns, Mur and Mürz, forms the baseline for balancing the efforts to reach the 2020 energy targets and at the same time avoid any (further) deterioration of the ecological state of the water bodies.

First of all the BWP provide the baseline conditions for any future hydropower planning. The information profiles, the deficit analysis and the general proposals of measures can be considered in the detailed planning processes. Furthermore, the BWP designate river stretches – an important issue in terms of strategic regional planning and also impacting the future development of renewable energy production in Styria. The development of a regional program (pursuant to the Austrian Water Act §55g WRG) shall give the designations a legal basis. The BWP will be valid until 2022 – they are the first planning of this kind in Austria.

It becomes apparent that by involving all relevant key stakeholders in a clearly structured planning process a mutually acceptable result in balancing the targets and requirements of different directives and diverging interests can be achieved.

The approach for developing these specific water management plans in Styria may serve as a blue print for similar plans in other European regions.

References

- Pöyry Energy GmbH (2008). Wasserkraftpotentialstudie Österreich Endbericht
- Schmutz S., Schinegger R., Muhar S., Preis S. and Jungwirth M. (2010). Ökologischer Zustand der Fließgewässer Österreichs – Perspektiven bei unterschiedlichen Nutzungsszenarien der Wasserkraft. Österreichische Wasser- und Abfallwirtschaft, Volume 62, Issue 7-8 pp 162-167
- Lebensministerium Österreich (2010). „Nationaler Gewässerbewirtschaftungsplan 2009 – NGP 2009 (BMLFUW-UW.4.1.2/0011-I/4/2010)
- Amt der Steiermärkischen Landesregierung – Abteilung 14, Wasserwirtschaft, Ressourcen und Nachhaltigkeit (2013). Wasserwirtschaftlicher Fachvorschlag zur Ausweisung von Gewässerstrecken mit besonderer ökologischer Bedeutung. Wasserland Steiermark (1/2014)
- Amt der Steiermärkischen Landesregierung - Fachabteilung 17A, Energiewirtschaft und allgemeine technische Angelegenheiten (2010), Klimaschutzplan Steiermark – Perspektive 2020/2030, 26 Maßnahmenbündel für eine zukunftssichernde Klimapolitik in der Steiermark.
- Energie Steiermark Green Power AG (2012), Potenzialstudie Wasserkraft Steiermark.

A qualitative cross-impact balance analysis of the hydrological impacts of land use change on channel morphology and the provision of stream channel services

Slawson D

DEBORAH SLAWSON

National Research Institute of Science and Technology for Environment and Agriculture (IRSTEA), Antony, France

Abstract

The need to attain or preserve good ecological status under the WFD increases the planning importance of the hydrogeomorphologic effects of land use change, which will be exacerbated by expanding populations, population redistribution, and climate change. Land use planners do not always take into account the long-term impacts of land cover and associated hydrology changes on the loss of or need for stream channel services. Current land use development is often opportunistic and may start with expensive and time consuming land acquisition, engineering design, permitting application, financial, and legal efforts. Stream restoration projects are often designed and implemented on relatively short reaches, usually in the context of current land use hydrology. Future changes in land use and the associated hydrology may reset stream channel geomorphologic evolution with unintended consequences on already existing restoration projects or may result in the need for future restoration. For REFORM, IRSTEA has developed a Cross-Impact Balance (CIB) analysis hypermatrix, in ScenarioWizard 4.11, for land use planners and stream restoration stakeholders to use as a tool to anticipate the potential impacts of drainage area hydrology changes on stream channel morphology, ecological function, and services provision.

Introduction

For REFORM, IRSTEA has developed a Cross-Impact Balance (CIB) analysis hypermatrix, in ScenarioWizard 4.11 (Weimer-Jehle, 2013), for land use planners and stream restoration stakeholders to use as a tool to anticipate the potential impacts of drainage area hydrology changes on stream channel morphology, ecological function, and services provision. This tool is designed for use by non-scientist planners to better understand the impacts of changed hydrology on stream channel services in headwater catchments. It may also be used by scientists and engineers as a tool to guide discussion with non-scientist planners.

The long-term impacts of land use change and the need for new or the potential loss of stream channel services are not always part of the initial analysis of a land use change proposal. Once significant time and money have been spent, it is often difficult for planners and enforcement agents to stop or reverse the course of land use change. The results may be costly to the taxpayer and the environment in the short and long-term.

Headwater stream restoration projects are often designed and implemented on relatively short reaches, usually in the context of current land use hydrology. Future changes in land use and the associated hydrology may reset stream channel geomorphologic evolution with unintended consequences on already existing restoration projects or may result in the need for future restoration.

An initial, qualitative impact analysis may be useful to municipal planners, regulatory agencies, investors, restoration designers, and other watershed stakeholders to get a more global view of the short and long-term impacts and the potential benefits and/or costs of land use change on stream channel services and restoration.

Hydrogeomorphology is a complex subject and may intimidate elected officials, citizen planners, and watershed stakeholders. There are many variables to consider, quantitative and qualitative. We have developed the CIB analysis hypermatrix to make initial analysis relatively accessible without the need for engineers or scientists. However, the use of the matrix and its future development would certainly be improved by additional expert judgment.

Context

Science and expert judgment

The CIB analysis hypermatrix involves calculated values, but may often include expert judgments as well. Ideally, the hypermatrix is populated during a process interaction between all stakeholders and scientific and professional experts. In the case of our CIB hypermatrix, the equations and some of the expert judgment come from the scientific literature, while the calculations and additional expert judgment are provided by the author.

General principles of hydrology, soil science, traditional and stormwater runoff best management practices (BMPs), hydraulics, sediment transport, and stream ecology were used as the basis for all decisions. The general context is confined to a temperate climate, moderate topography (not mountainous or tidal), mixed geology (no extensive karst features or active tectonics), and North American or European cultural norms. Use of this hypermatrix for a particular site may require that the underlying decisions made in its creation be reviewed by experts for applicability to all contextual aspects.

Stream channel services provision

Stream channel services are affected by the relationships between 1. land use, land management, and land cover; 2. runoff and sediment regimes to the channel; 3. changes in channel morphology; and 4. provision of stream channel services. The services may be divided into three distinct groups.

- Process regulation services: flood control, stormwater conveyance
- Use services: energy, navigation, water supply
- Ecosystem services: habitat and biological diversity, autopurification, temperature control

Methods

The CIB Analysis Tool

To get an initial idea of the interactions consequent to a proposed change in land use, an impact analysis tool for municipal planners, regulatory agencies, investors, and other watershed stakeholders to determine the effects of land use change on hydrology, channel morphology, and stream services would be very useful. Such a tool must have several important characteristics, including,

- Be understandable and useable by and transparent to both policy makers and technical experts
- Incorporate scientific principles and expert social, legal, and scientific judgment

- Accept both quantitative and qualitative data
- Include spatial information
- Not require temporal information
- Be able to handle multiple descriptors with conflicting possible states
- Enable the selection of different scenarios
- Indicate consistencies and inconsistencies of scenarios

Cross-impact balance analysis, using ScenarioWizard 4.11: Constructing Consistent Scenarios Using Cross-Impact Balance (CIB) Analysis (Weimer-Jehle, 2013), is such a tool. For analytical tasks that do not permit the exclusive use of computational models due to their disciplinary complexity and the inclusion of qualitative knowledge, but that are too complex for an argumentative systems analysis, cross-impact analyses may be useful. (Weimer-Jehle, 2013) CIB analysis is used to explore the interdependence of multidisciplinary network elements and to develop network behavior scenarios by determining the conditional probability of event pairs.

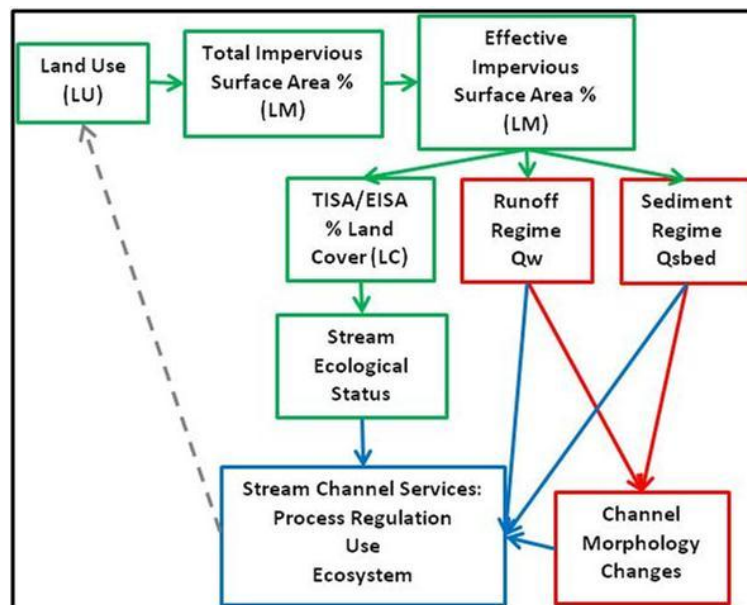

Figure 1. Map of CIB analysis descriptor interactions. The dashed grey line is not part of the CIB analysis, but rather indicates the possibility of resetting the scenario to achieve different results.

A CIB Analysis Application

A hypermatrix was created with 14 descriptors, 9 of which are primary descriptors (Figure 1) and 5 are intermediate linking descriptors, each having between 4 and 9 possible states. The descriptors and their states were chosen to

1. link land use through land management to land cover;
2. link the impacts of land cover changes on stream ecological quality;
3. link land cover changes to changes in flow and sediment regimes and resulting changes in channel morphology; and
4. link the changes in stream ecological quality, regime changes, and channel morphology to the provision of stream channel services.

Hypothetical Land Use Change Example

An example land use change proposal for a 15 ha plot presents a change of use from perennial agriculture using good soil conservation practices to a high density residential land use. Two alternative land management approaches are considered, the traditional, complete storm sewer system approach and the maximum detention and stormwater infiltration approach.

1. Initial land use scenario: perennial agricultural
Total impervious surface area (ISA): 0.75 ha (5%)
Choose agricultural practice: soil conservation agricultural practices
Calculate effective ISA: 0.006 ha
Calculate percent of parcel effective ISA: 0.04%
2. Planned land use Scenario A: traditional high density residential
Total ISA area: 11.5 ha (77%)
Choose effective ISA equation: totally connected EIA = ISA (Sutherland, 2000)
Calculate effective ISA: 11.5 ha
Calculate percent of parcel effective ISA: 77%
3. Planned land use Scenario B: high density residential with maximum detention and stormwater infiltration
Total ISA area: 11.5 ha (77%)
Choose effective ISA eq.: somewhat connected EISA = $0.04 \text{ ISA}^{1.7}$ (Sutherland, 2000)
Calculate effective ISA: 2.54 ha
Calculate percent of parcel effective ISA: 17%

Results of the CIB Matrix Analysis

In Table 1, the direction and degree of regime and channel morphology changes are given for each variation with the likely change in stream channel service provision and a score.

Conclusion

The utility of the hypermatrix lies in the relative simplicity of the links between descriptors, the incorporation of scientific expert judgment, and the accessibility of the ScenarioWizard 4.11 platform. Using this hypermatrix may encourage land use planners and stream restoration project decision-makers to consider the long-term impacts of land use change on hydrogeomorphology, the provision of stream channel services, and the resulting, potential costs and/or benefits.

Table 1. CIB analysis impact scores for two, proposed, high density residential land uses with different land management approaches on a parcel with an initial use of perennial agriculture using soil conservation practices. Where: Q_w = water discharge, Q_{sbed} = bedload, w = channel width, d = channel depth, w/d = width to depth ratio, su = sinuosity, and S = slope. (Schumm, 1969).

CIB analysis impact scores by Stream Channel Service for 3 Land Use Change Scenarios			
Stream Channel Services	Initial Score: Perennial Agriculture with Equilibrium Channel (Q_w0, Q_{sbed0})	Impact Score: High Density Residential Traditional ($Q_w++, Q_{sbed--}, d+, w/d-, S-$)	Proposed Scenario A Impact Score: High Density Residential Stormwater BMPs ($Q_w+, Q_{sbed+}, w+, w/d+, su-$)
Flood control	0 Not needed.	-1 Flood control is now needed due to increased flow.	0 May not be needed. Runoff retained in upper watershed.
Storm sewer connectivity	0 Not needed.	-1 Stream channels will now act as stormwater conveyances. Channel incision will reduce floodplain connectivity.	0 May not be needed. No direct storm sewer outfalls.
Water quality	0 Good. No excess sediment.	-2 Degradation due to increased runoff pollutant concentrations.	-1 Some degradation due to increased runoff pollutants and sediment (turbidity).
Biology	0 Sensitive. Good water quality.	-4 Urban drainage. No biosystem due to poor water quality and increased flow energy. Base flow probably reduced.	-1 Impacted. Some loss of biodiversity due to decrease in WQ (increased temperature) and to loss of bed habitat diversity with increase in w/d .
Ecological status	0 Sensitive species supported.	-4 Urban drainage. Poor.	-1 Impacted. Possible status degradation.
Reservoir capacity	0 If use present, no change.	-1 If use present, decrease in WQ. Elevation control infrastructure possibly at risk.	-1 If use present, decrease in WQ and possible sedimentation.
Navigability	0 If use present, no change.	2 If use is not present, it may become possible with increase in flow and decrease in sediment.	-1 If use present, decrease in flow depth.
Hydro-energy capacity	0 If use present, no change.	2 If use is not present, it may become possible with increase in flow and decrease in sediment.	1 If use is not present, it may become possible with increase in flow.

References

- Schumm, S. A., 1969, River Metamorphosis, Journal of the Hydraulics Division, American Society of Civil Engineers 95(HY1):255-73.
- Sutherland, R., 2000, Methods for Estimating Effective Impervious Cover. Article 32 in: The Practice of Watershed Protection, Center for Watershed Protection, Ellicott City, MD.
- Weimer-Jehle, W., 2013, ScenarioWizard 4.1 Constructing Consistent Scenarios Using Cross-Impact Balance Analysis, Manual, ZIRIUS, Univ. of Stuttgart.

Social and economic perspectives of river restoration

Sterk M & Bekhuis J

MARJOLEIN STERK^{1,2} & JOHAN BEKHUIS²

¹Environmental Systems Analyses Group, Wageningen UR, Postbus 47, 6700 AA Wageningen, the Netherlands

²ARK Nature Development; Molenveldlaan 43; 6523 RJ Nijmegen, the Netherlands

In the Netherlands floodplains are traditionally designed for the storage of river water. The main land use is agriculture but also clay mining and sand extraction are important activities. With climate change we are facing more extreme floods and droughts in our river system. ARK and WWF stimulated spatial solutions to solve future hydrological problems. Not only for nature but also to promote chances for other actors. With the release of the river rehabilitation project "Plan Ooievaar" in the 90s a successful series of nature development projects started in the basins of the Meuse and Rhine in cooperation with surprising stakeholders like stone factories that provided co-finance. Free accessibility for visitors was a prerequisite to generate higher acceptance and to stimulate green tourism. And it was successful.

The project 'Free accessibility pays' (2012) examined the effect of nature development and free access on the local leisure economy. The study compared three areas: Brabant diked Meuse, the Middle IJssel and the Gelderse Poort with respectively an increasing amount of free accessible nature. The leisure economy of the Gelderse Poort, scores the highest, expressed in number of jobs (170) and visitors' spending (6.3 million euros). The difference between the Brabant diked Meuse (agriculture) and the Middle IJssel (limited access) is significant, approximately a factor of two. This 'foraging economy' of the Gelderse Poort is not only generating an income for many people it also contributes to a higher acceptance of nature development, especially in urban areas.

Introduction

The natural river landscapes in NW Europe have changed over the last few centuries due to human activities. Regulation of rivers have ensured quick runoff of water, ice and sediments and at the same time enhanced navigation. Levees were raised to protect people and goods from flooding. The remaining floodplain areas are used almost completely for agriculture and at some places gravel, sand or clay mining is carried out (Van Dijk et al., 1995). With climate change we are facing more extreme floods and droughts in our river system and long-term solutions are needed. ARK Nature Development (ARK) and the World Wildlife Fund (WWF) stimulate spatial solutions to solve future hydrological problems in the Netherlands. However, space is scarce as apart from flood protection other river functions claim the scarce available space, like urbanization, industry, recreation, agriculture and nature (Lorenz et al., 1997). Therefore, strategies in flood risk management should result in so called 'win-win' situations, i.e. measures that are beneficial for various river functions. Several functions, e.g. nature, could benefit from the changes in river management that will take place to improve hydrology.

Natural features of river systems are the result of dynamic geomorphological processes (Wolfert et al., 2001). As a result of the above-mentioned activities the impact of these processes diminished and the river landscape deteriorated. In recent decades national and international programmes have started aiming at the ecological rehabilitation of river systems. The guiding principle for this needs to be the natural river processes like hydro- and morphodynamics. The translation of new flood protection strategies into daily practice incorporating ecological rehabilitation goals, calls for new approaches which can help the stakeholders to explore future challenges (Smits et al., 2000). Both flood protection and river rehabilitation are strongly served by an integrated approach on a river basin level, partly as space is scarce, partly as problems cannot always be solved at the particular site in question. For both flood protection and river rehabilitation it is not enough to have sufficient space; a good spatial connectivity is also important, even a necessity. With the release of the river rehabilitation project "Plan Ooievaar" in the 90s a successful series of nature development projects started in the basins of the Meuse and Rhine in cooperation with surprising stakeholders like stone factories that provided co-finance. Free accessibility for visitors was a prerequisite to generate higher acceptance and to stimulate green tourism. And it was successful.

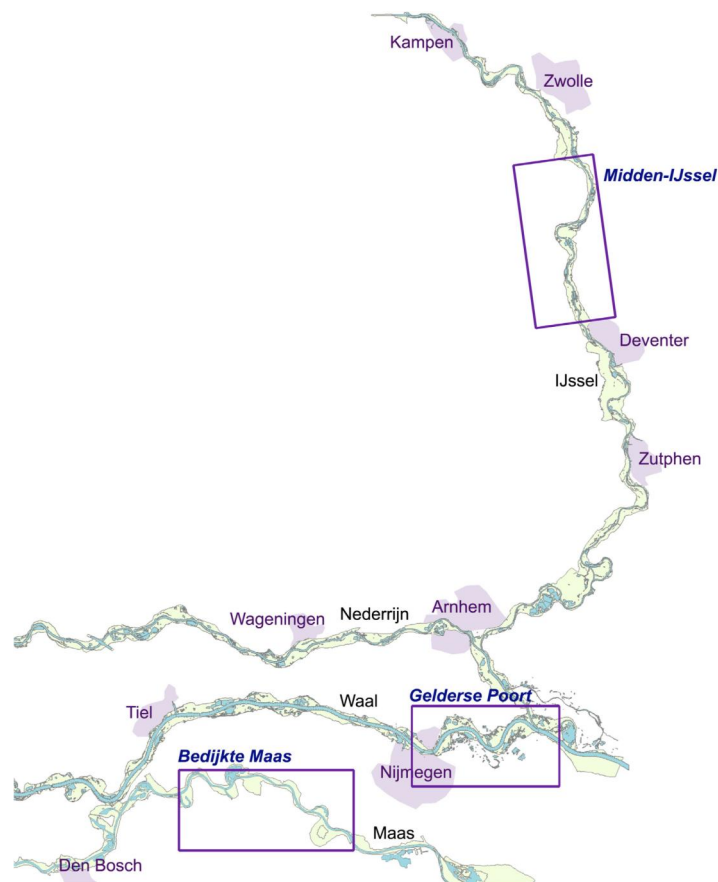

Figure 1 Geographic location of the study areas

The project 'Free accessibility pays' (van de Laar and Lycklama, 2012) quantified the effect of nature development and free access on the local leisure economy. The study compared three areas: Brabant diked Meuse (hereafter called Meuse), the Middle IJssel (hereafter called IJssel) and the Gelderse Poort along the Waal (hereafter called Waal) with respectively an increasing amount of free accessible nature (Figure 1). Two

questions were studied: (i) are there differences in local leisure economy between river systems with, and river systems without nature development? (ii) are the differences in local leisure economy related to extent of open access nature in the river system?

Methods

The study compared three areas: Meuse (7.000 ha), IJssel (11.866 ha), Waal (4.938) with respectively an increasing amount of free accessible nature. The selection of the three study areas is based on four parameters (Table 1):

1. The largest part of the study areas belongs to the river system, and the related parameters e.g. length of the river reach and surface of the floodplain are comparable;
2. The areas are significant different concerning the extent of nature development; The areas differ in the extent of open access nature;
3. The areas differ in the extent of agricultural activities.

Table 6 Development area nature and agriculture in the floodplain 1996-2010

	Area floodplain (ha)	Water in floodplain (ha)	Nature in floodplain (ha)	Agriculture in floodplain (ha)
Waal				
2010	1.215	506	610	36
1996	1.215	498	140	530
IJssel				
2010	1.648	350	641	582
1996	1.648	399	102	1066
Meuse				
2010	1.249	135	8	1068
1996	1.249	131	9	1069

To compare the local leisure economy in the selected study areas data is collected from the tourism sector localized close to the river system for:

1. Employment;
2. Expenditures;
3. Activities.

The data is collected on municipality level and related to local leisure economy in floodplains. For instance walking, biking and water leisure.

Results

The leisure economy of the Gelderse Poort, scores the highest, expressed in number of jobs (170) and visitors' spending (6.3 million euros). The difference between the Brabant diked Meuse (agriculture) and the Middle IJssel (limited access) is significant, approximately a factor of two (Figure 2). For activities the differences are less clear.

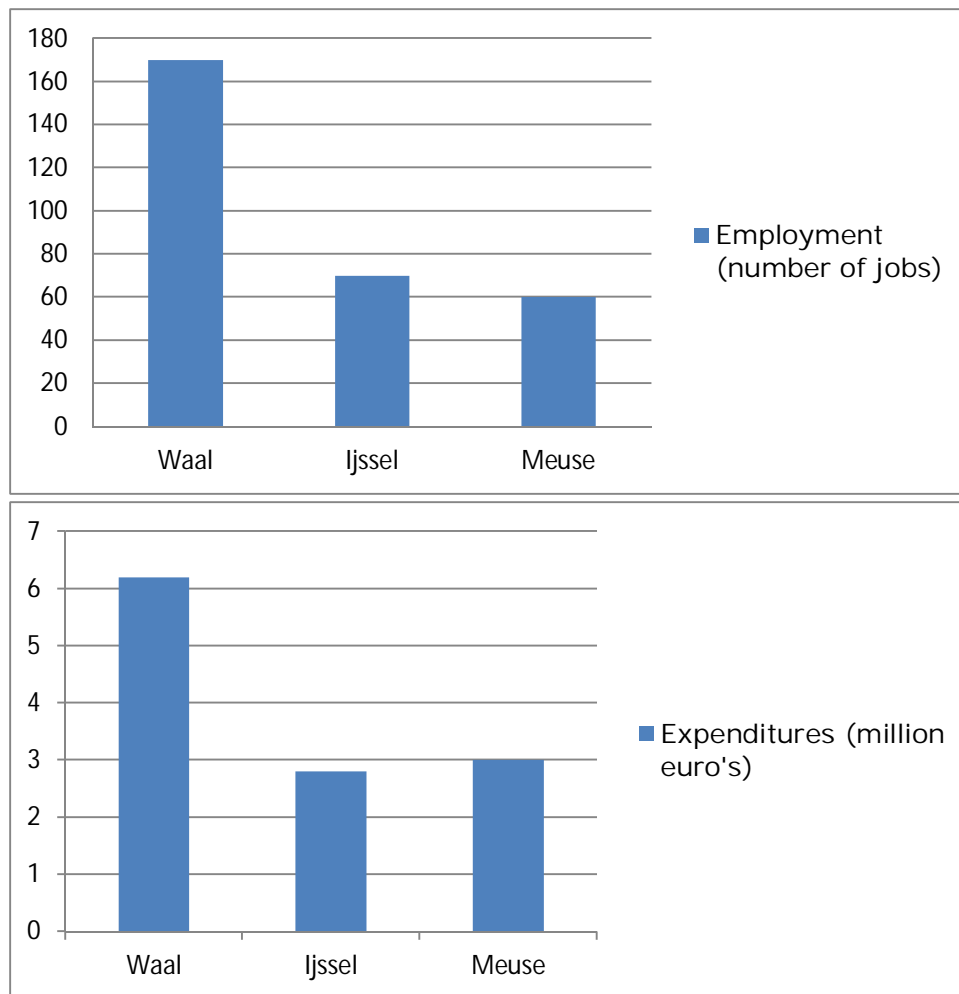

Figure 2. Results of the different measurements of local leisure economy in the study areas (Top) Employment (Bottom) Expenditures.

Conclusions

This 'foraging economy' of the Gelderse Poort is not only generating an income for many people it also contributes to a higher acceptance of nature development, especially in urban areas. It created support for other projects.

Activities are not significantly increasing because other factors than nature development play a role. The area must be interesting to visit for more than one day and for other groups than 'nature-lovers'.

If the IJssel and Meuse continue nature development including open access their local leisure economy will grow like the one from the Waal.

References

Geilen, N., Jochems, H., Krebs, L., Muller, S., Pedroli, B., Van der Sluis, T., Van Looy, K., Van Rooij, S. (2004). Integration of ecological aspects in flood protection strategies: defining an ecological minimum. *River Research and Applications*, 20(3), 269-283.

Lorenz, C.M, Van Dijk, G.M, Van Hattum, A.G.M., Cofino, W.P. (1997). Concepts in river ecology: implications for indicator development. *Regulated Rivers: Research & Management* 13: 501-516.

Sijmons, D., van Nieuwenhuijze, L., Hamhuis, D., de Bruin, D., Overmars, W., Vera, F. (1986). Plan ooievaar, the "Casco" concept. <http://www.hnsland.nl/images/stories/english/ooievaar/Ooievaar.pdf>.

- Smits, A.J.M., Nienhuis, P.H., Leuven, R.S.E.W. (eds) (2000). *New Approaches to River Management*. Backhuys: Leiden.
- Van de Laar, S. and Lycklama, T. (2012). Openstelling loont! (Dutch).
- Van Dijk, G.M., Martijn, E.C.L., Schulte-Wülwer-Leidig, A. (1995). Ecological rehabilitation of the river Rhine: plans, progress and perspectives. *Regulated Rivers: Research & Management* 11: 377–388.
- Wolfert, H, Hommel, P, Prins, A, Stam, M.H.(2001). The formation of natural levees as a disturbance process significant to the conservation of riverine pastures. *Landscape Ecology* 17(Suppl. 1): 47–57.

The revised water protection law of Switzerland and its implementation to practice

Thomas G

GREGOR THOMAS

Federal Office for the Environment (FOEN), Water Division
3003 Berne, Switzerland

Abstract

Running waters in Switzerland have been under various anthropogenic pressures. Approximately 50% of streams and rivers in the Swiss lowland (< 600 m a.s.l.) show a deficient morphology (straightened, bank fixations, low habitat variability) and numerous barriers and sills disrupt longitudinal connectivity. Due to the country's topology hydropower is a major branch of industry, providing 55% of the Swiss energy supply. Though this energy source is carbon-neutral, ecological drawbacks result in a disturbed sediment transport, disrupted fish migration and hydropeaking.

In 2011, the water protection law of Switzerland has been revised, as a consequence of a popular initiative.

Legislative modifications are:

1. A riverine zone has to be defined for the majority of streams and rivers until 2018, (which protect riparian strips from future degradation; only extensive agricultural land use is permitted)
2. Measures to mitigate negative effects resulting from hydropower production will be implemented until 2030 (sediment transport, fish migration, hydropeaking).
3. Approx. one quarter of stream reaches with poor morphology (~4,000 km) should be restored within the next 80 years.

To reach those goals approx. 110 million CHF (110 million €) from federal funds are reserved annually. Tools created by the FOEN support the cantons by implementing the revised water protection law into practice, and to provide a standardized protocol. Each of the 26 Swiss cantons had to submit a strategic planning by the end of 2014. Details and results from the restoration planning are presented.

Introduction

During the 19th and 20th century, like in many other European countries, the majority of rivers and streams in Switzerland lost their nativeness due to the straightening and channelization of the stream channel. Reasons for such engineering measures were flood protection and to gain land for agricultural land use. Especially in the low altitude regions and in the valleys the majority of streams and rivers have been altered substantially in their morphology. Due to the economic development and population growth, the demand for land and land use intensity grows further.

A tool to evaluate the nativeness of bed morphology of running waters have been established in the 1990's, categorizing morphology into five classes (natural, near-natural, heavily impaired, artificial, culvertized) and meanwhile the morphological status has been compiled for most streams and rivers from a certain size (Zeh Weissmann, Könitzer et al. 2009). This inventory has revealed that 22% of total 65,000 km running

waters in Switzerland are in heavily impaired morphological condition or even worse (heavily impaired, artificial, culvertized). From those 16,000 km, which are located below 600 m a.s.l., where urbanization and agricultural land use is most intense, around 46% of stream reaches show a poor morphology. In contrast, 95% (from 27,000 km) in altitudes above 1,200 m a.s.l. are in a natural or near-natural state.

Due to the country's topology and water richness, hydropower production is important for the country's energy supply. Approx. 55% of the energy is produced by hydropower. Around 90% of this energy is produced by large hydropower plants with 580 generators (>300 MW) and additional 3,400 GWh resulting from >1,000 small hydro power plants (Swiss Federal Office of Energy SFOE). However, dams retain gravel, disturb sediment transport and disrupt longitudinal connectivity, storage dams in the Alps lead to hydropeaking in the downriver reaches.

Longitudinal fragmentation resulting from hydropower dams and sills is high, more than 100,000 barriers with a heights of 0.5 m and more disrupt free migration of aquatic species. Therefore all anadromous fish species in Switzerland became extinct and potamodromous species are threatened (Kirchhofer, Breitenstein et al. 2007).

The revised water protection law

In 2005 the Swiss Fishery Organization launched a popular initiative to return Swiss rivers to a more natural state. In 2009 the Swiss parliament accepted a parliamentary counter proposal and in 2011 the revised water protection law became effective.

The revised law has the following consequences:

By the end of 2018 the cantons have to define a riverine zone for the majority of their streams and rivers. This zone has to be at least 11 m in width (for small streams) and has to increase for larger streams (e.g. 19 m for streams with a width of 5 m; 32 m for streams with a width of 10 m). For large rivers, an expert's expertise is necessary to define the riverine zone. There is a right for continuance for existing infrastructure and housing in this zone. The construction of additional housing and infrastructure in the future is limited to core zones of urbanization. The riverine zone is restricted to extensive agricultural use, manuring, plowing or use of pesticides is prohibiting to in those areas. Annually 20 million Swiss francs are available for compensation payments to farmers for the extensive cultivation.

The restoration of negative impacts of hydropower production is funded by an extra toll on the utilization of the Swiss electricity network (Swissgrid). It is assumed that approximately 50 million Swiss francs result from this fee annually. Negative impacts resulting from hydropower production have to be restored until 2030 (hydropeaking, sediment transport, fish migration). Measures will be funded to 100% by the Swissgrid credit.

A credit of 40 million Swiss francs from federal funds is available each year to restore running and standing waters. This credit is expected to be available for the following 80 years. It is estimated, that around 4,000 km streams and rivers (out of 16,000 km degraded) will be restored with the money available in this time. Projects have to be initialized by municipalities and/or cantons but can be funded between 35-80% with

federal funds. The basic funding of 35% can be raised, if additional lateral space is added to the perimeter (+25 or 40%), a large (+20%) or medium (+10%) ecological benefit has been identified by the strategic planning (details see below), another 10% can be gained if recreation is important (for a limited number of projects). In total, the federal share is limited to 80% of total project costs.

Restoration planning:

By the end of 2014 all 26 cantons were asked to submit strategic planning to restore degraded streambed morphology of running waters, as well as to restore negative impacts of hydropower production, in each of the three sectors: hydropeaking, sediment transport and fish migration.

Manuals, which suggest an approach based on the legislation to carry out those strategic plannings, for each of the four topics have been elaborated by FOEN with support from the cantons. Those manuals give assistance to the cantons to implement the revised water protection law into practice and to guarantee a comparable standard between all cantons.

Below the suggested approach to carry out the strategic planning is presented in more detail.

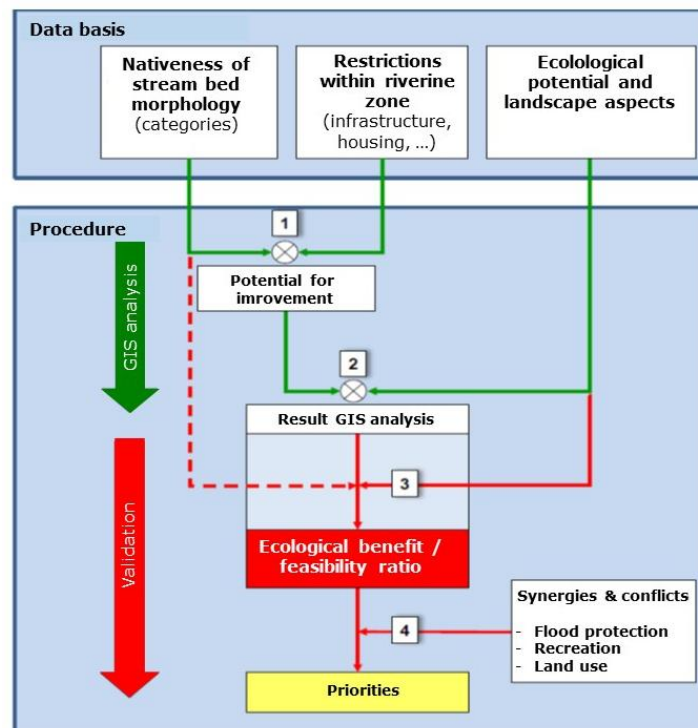

Figure 1. Suggested procedure of the strategic restoration-planning manual to identify stream reaches with the highest ecological benefit resulting from restoration.

As described above the strategic restoration planning is an essential part of the federal funding concept. Restoration measures should be carried out in stream reaches where a large ecological benefit can be expected from restoration. To reach those goals the

manual for strategic planning suggests the approach displayed in Figure 1 (Göggel 2012).

In a first step available geodata, regarding nativeness of morphology, restrictions (e.g. cadastral land register) and ecological aspects (e.g. inventoried protected areas) get blended in a GIS analysis. In a second step stream reaches identified by this automated procedure get validated by a round of experts (members from various cantonal departments, e.g. environment, flood protection, agriculture, conservation). In a third step, priorities for the realization of projects are defined by the experts and terms are defined. All steps in this procedure need to be documented (see figure 2). As a result, the strategic planning illustrate those reaches, where the ecological benefit is high, medium or low. This categorization is important to determine the amount of federal funding for a project, beside other factors (listed above). The strategic planning covers a time period of 20 years and need to be updated every 12 years.

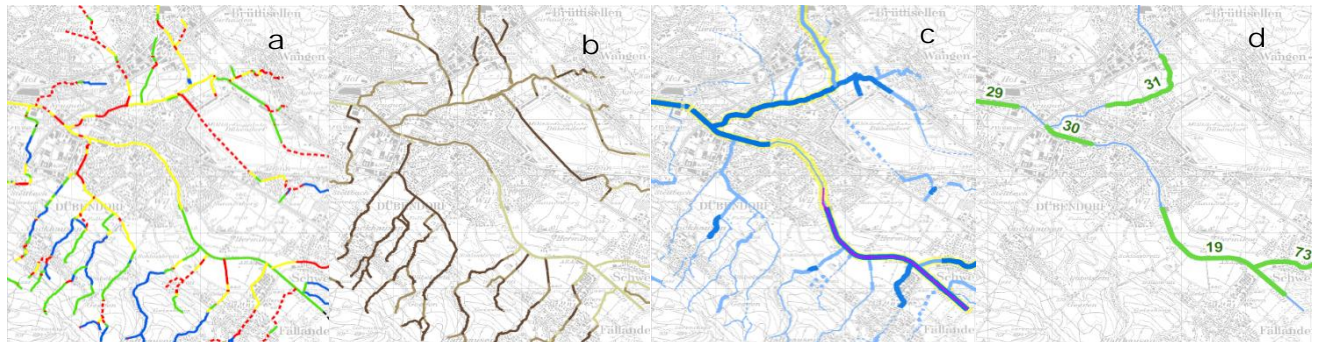

Figure 2. Output from the strategic restoration planning is displayed in four maps (example from the Glatt system, a river in canton of Zurich): a) nativeness of streambed morphology, b) ecological potential, c) ecological benefit to feasibility ratio, d) priorities.

Implementation to practice:

Between the FOEN and the 26 cantons, contracts are made for a 4-years term. At the beginning of each of such periods, projects and funding are defined. The amount of federal fund being available for each canton depends in part on the length of the cantonal water system and the quality of the morphology.

At the moment the restoration of running water is in the focus but a strategic planning on the restoration of lakes is planned in the future (same federal budget).

References

- Göggel, W. (2012). "Revitalisierung Fließgewässer. Strategische Planung. Ein Modul der Vollzugshilfe Renaturierung der Gewässer." Umwelt-Vollzug 1208: 42.
- Kirchhofer, A., et al. (2007). "Rote Liste der Fische und Rundmäuler der Schweiz." Umwelt-Vollzug 0734.: 64.
- Zeh Weissmann, H., et al. (2009). "Strukturen der Fließgewässer in der Schweiz. Zustand von Sohle, Ufer und Umland (Ökomorphologie); Ergebnisse der ökomorphologischen Kartierung. Stand: April 2009." Umwelt-Zustand 0926: 100.

Lower Danube 4D Reconnection – Strategic Framework for LU/climate change adaptation

Nichersu I, Staras M & Feodot I

IULIAN NICHERSU, MIRCEA STARAS & I. FEODOT
*Danube Delta National Institute for Research and Development, Tulcea
Tulcea, Romania*

Abstract.

Nowadays, about 80% of the Danube Floodplain – Romanian sector are embanked and arranged with desiccation works and locally with drainage. Once with increasing pressures on the system and the complexity of the issues, there has been developed a number of mechanisms by which human activity (LU change) influence the stability and services of ecosystems and the need for planning tools are changing rapidly. Motivated by dramatic climate change in recent decades and especially increased frequency of extreme events, we focused our efforts on developing models and scenarios of climate change, especially those related to land use change and flooding affecting local communities/ regions. Thus, in the given circumstances, the best option is to foresee a policy on the Lower Danube riverbed, followed by a series of advanced tools for exploring the 4D reconnection (longitudinal, lateral, vertical and temporal) and a well prepared monitoring system alert address to detected threats. 4D Reconnection of the Lower Danube floodplain will have to provide a spatial planning tool, developed in accordance with this three features, and built to design, analyse and evaluate long-term policies in an ecological, social, economic and cultural context. By transferring river restoration and risk information into spatial planning is assured the defining of the vision and strategy for sustainable development in the Lower Danube Valley, as an win-win scenario and an instrument for Integrated Management (ecosystem and adaptive).

Introduction

Danube Floodplain is the newest part of the Lower Danube Valley, set up by the complexity of the lateral erosion river accumulation, influenced by the general tendency of rising of water bed in Holocene and of common oscillations of the river (seasonal and accidental) of the levels and flows. The generic denomination of Floodplain of Lower Danube implies all that Danube built by alluvia and subject to its waters: the floodplain itself stretched upstream Calarași, Balta Borcei and Balta Brailei. Danube fen, downstream of Silistra are a floodplain created by two or more branches, where the alluvial processes, directly or through narrow channels, is directed from outside to inside.

During the last century, the floodplain of the Danube – Romanian sector was embanked on vast territories, the natural ecosystems of the area having been consistently altered and lost, developing agricultural polders and fish ponds.

Nowadays, about 473,556 ha from the area of the Danube Floodplain – Romanian sector (from the total of 573,440 ha) are embanked and arranged with desiccation works and locally with drainage (418,000 ha) in agricultural polders. During the season of floods the water from polders is pomp out to the river, and during the vegetation season, the Danube waters are usually used for irrigation. Also, some accumulations like Bistreț,

Suhaia, Calarași, Bugeac, Oltina, Dunareni, Vederoasa, Jijila, were dimensioned for fishponds.

Areas under natural conditions were limited to only 83,900 ha distributed at the mouth of the Danube tributaries and Little Island of Braila.

If fluvial dynamics cannot create new ecosystems, embanking areas of floodplain tend to desertification understood as a phenomenon of change of wetland ecosystem into terrestrial ecosystems under anthropogenic impact.

Embankment works executed on a distance of about 1,200 km over Romanian bank of Lower Danube, in order to obtain arable land, led to the disappearance of the floodplain. The effects of this action have occurred much later and were manifested by:

Desertification of land and increasing salinization of soils; connectivity interruption 4D (longitudinal, lateral, vertical, temporal); loss of habitat for wetland species; changes in the structure and composition of vegetation; landscape fragmentation and disruption of fish circulation from / into the river to / from the lacustrine basins (where they had optimal breeding conditions and led to change of fish specific spectrum and dramatically declining of fisheries with high economic value, in particular Carp - due to the loss areas with shallow water suitable for spawning and feeding juveniles); loss of organic matter through mineralization; eliminating retention function through stopping of filtering role of sediment and nutrients which entering with flood water.

Once with increasing pressures on the system and the complexity of the issues, there has developed a number of mechanisms by which human activity (LU change) influence the stability and services of ecosystems and the need for planning tools are changing rapidly. As is well known, the productivity and stability of ecosystems is directly dependent on their ability to support, to provide physical support for the use of natural resources and providing socio-economic system. Therefore the analysis of ecosystems as dynamic, nonlinear and productive units, in terms of climate change and LU assume three aspects:

- The Danube should be considered as a whole with hierarchical and holarchy classification of subsystems and functional/structural changes has chaotic character.
- Secondly, human systems and natural systems are dynamic and constantly evolving.
- The third aspect is that although the Danube system is organized spatially clustered, in same time it is discontinuous (fragmented) and creates restrictions in the functioning of the system.

The 4 dimensions synergies analyze in the Lower Danube

Geographically and evolution in historical time, Lower Danube Floodplain, was set in space with diverse landscapes where are concentrate ecosystems differentiated on categories, type, heterogeneity, spatial and temporal dynamics, or human intervention stage. Existing databases referenced spatially for assessing these correlations are insufficient, which requiring a typological approach (different types of interventions are correlated with different characteristics in terms of determining the importance of impact).

Temporal dimension

The temporal dimension emphasizes the correlation between economic/technological development and environmental impact intensity on physical environment of terrestrial ecosystems. Anthropogenic degradation of aquatic ecosystems is a pervasive reality with major implications for centuries (Figure 1).

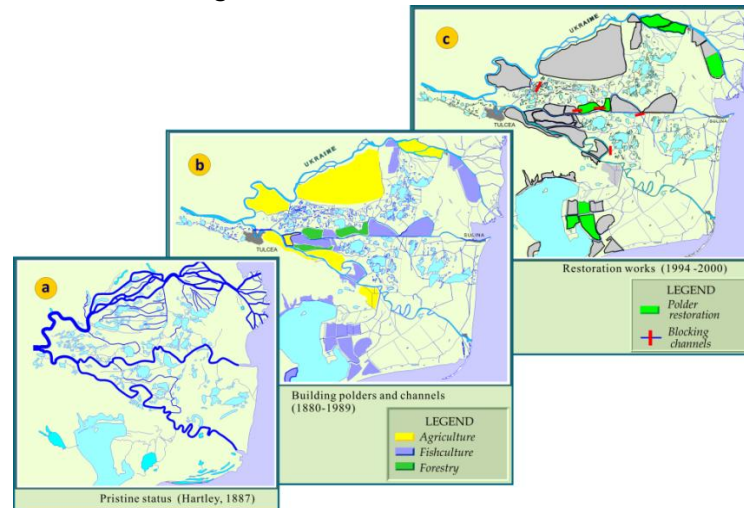

Figure 1. Temporal Dimension – Danube Delta case.

Spatial dimension

Spatial dimension is approaching the handling of physical-geographical environment by affecting / inhibiting natural processes - river hydrology, wind and micro-climate related. A proper functioning of ecosystems determines self-regulation processes that maintain sustainable flows of matter and energy, which by anthropogenic changes in floodplains causes degradation processes (morphologic, chemical, biological or hydrological), all of them creating pressure on the structure and functions (Schneider 2002).

Land use causes unprecedented changes in landscapes, ecosystems and the environment. Urban areas and related infrastructure are land users with the fastest growing mainly for productive agricultural land. Recent developments in the Lower Danube Floodplain under anthropogenic pressure (intensive exploitation of natural resources, increasing land extension built - agricultural polders, fish ponds at the expense of natural ecosystems, riparian ecosystems profound transformation leads to the obvious decrease in productivity, but and disruption to their functionality. Especially in the Lower Danube Floodplain, space administration and habitat management, requires identifying ways and means of restoration, conservation, protection and social management of ecosystems and landscapes. The changes in the use of land, qualitatively had changed of the ecological structure of original units, which was natural equipotential geosystem, and artificialized this equipotential units areas into rhexistazy state witch influenced fluvial hydraulics and increased flood risk (Figure 2).

Thematic dimension

The thematic dimension explains catastrophic changes on the biosphere of Danube Floodplain based on excess of transition limits which inhibits natural processes. Two types of barriers have limited the functions of affected ecosystems and thus requiring two different approaches. The first refers to the cycle of soil degradation and the

appearance of invasive species. A second barrier occurs when dysfunctional a hydrological process creates abiotic limitations in the functioning of ecosystems, especially in extreme situations - floods, droughts. During the season of floods the water from polders is pump out to the river, and during the vegetation season, the Danube waters are usually used for irrigation. Also, some accumulations like Bistreț, Suhaia, Calarași, Bugeac, Oltina, Dunareni, Vederoasa, Jijila, were dimensioned for fishponds.

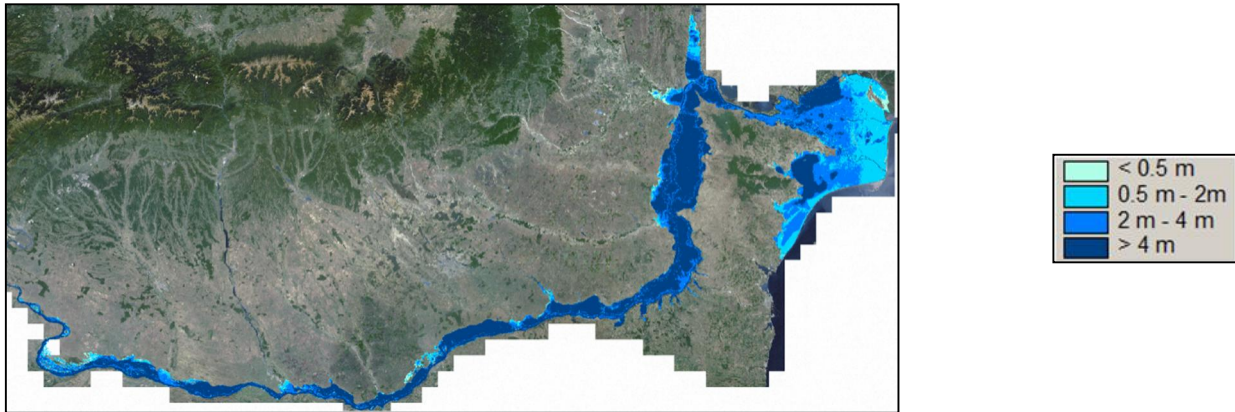

Figure 2. Hazard maps of the lower Danube- 1000 years insurance.

Teleological dimension

Teleological dimension, balance and economic-ecological efficiency (energetically) involve assessing of human practice, seen in terms of resource use, in terms of consequences for the integrity of ecological systems, meaning a larger effort to operationalize resource management models, such be ensured the essential needs and preserve the freedom of the future generations in this area. Also, deontological ethics extended, which can be called ecological ethics presupposes such a resource management model that allows preservation conditions for survival of all life.

Compatibility assessment between the economic activities and ecological functions means, ultimately, formulating a comprehensive diagnostic on the operation based on ecological balance and economic efficiency (energy).

The Ecological and Economical Resizing of Lower Danube Floodplain Program (REELD) (Nichersu 2006) represents the strategy for implementation of WFD, Natura 2000 and Floods Directives, through Strategic Framework for LU/climate change adaptation. The program, as decision making, is structured on three main levels (identification, evaluation and prioritization) and establishes three priorities:

- Localities defense line reassessment;
- To evaluate the pretability of economical activities from polders in order to their restoration as mixed polders (agricultural polders and water stoking polders);
- Restoration of some polders in order to create Natura 2000 wetlands

Objectives:

- to fit in hydrological natural regime (4D connection);
- restoration of hydrological and ecological equilibrium;
- restoration of new habitats in wetlands;
- development of traditional activities: fishing, grazing, natural resources harvesting, ecotourism;

The REELD program purpose is an overlapping between results of hydraulic modelling and economic pretability assessment for a thoroughgoing and coherent scientific plan leading to sustainable development. In the same time the scenarios elaborated offer the idea of alternative technical solutions of sustainable use of Lower Danube polders/ponds, through 4D reconnection.

Conclusions

By transferring risk information and ecological restoration of polders/ponds with negative ecological/economical balance, into spatial planning are assured the defining of the vision and strategy for Integrated Management (ecosystemic and adaptive) and Sustainable Development in the Danube Valley.

Based on flood risk maps, hydrological scenarios focused on quantification reducing of the Danube level at maximum levels during floods and spatial distribution of possible areas of intervention (using multi criterial dynamic assessment–MCDA), REELD concept and program lead to Win-win scenario for Lower Danube 4D reconnection: Mixed solution of water storage in some farm precincts and natural flooding in others, is a realistic solution that can combine flood protection requirement with the restoration and economic benefits, especially in terms of climate and land use change adaptation (Figure 3).

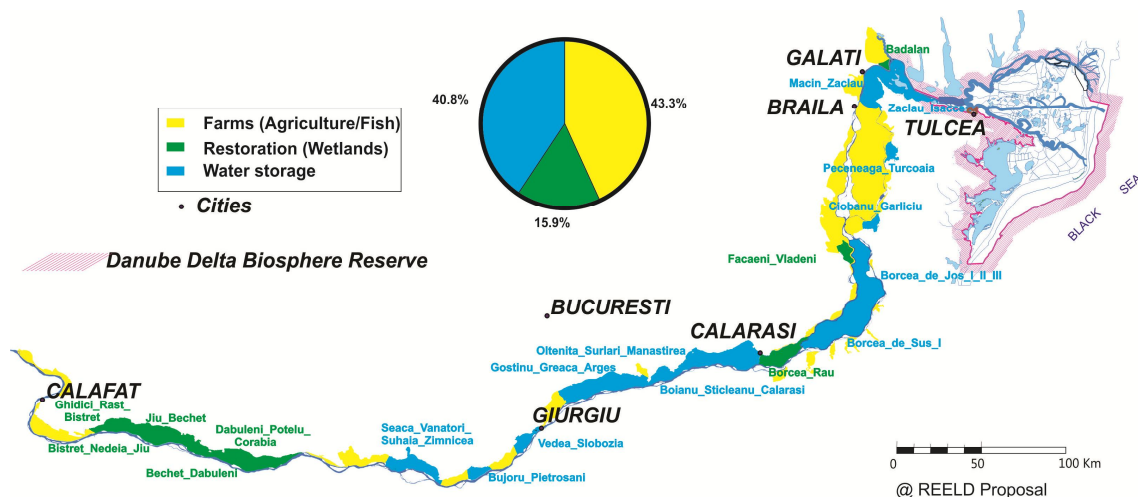

Figure 3. Win-win Scenario with mixed solution.

References

Nichersu, I. (2006). Report of Ecological and Economical Resizing of Lower Danube Floodplain (REELD) Program - Romanian Government Decision HG 1208 /06.09.2006 www.mmediu.ro/vechi/lunca-dunarii/REELD_MMDD_sinteza.pdf INCDDD Tulcea.

Schneider, E. (2002). The ecological functions of the Danubian floodplains and their restoration with special regard to the Lower Danube.). Arch. Hydrobiol. 141 (Suppl.), (Large Rivers 13):129-149.

9. LINKING SCIENCE TO PRACTICE: TOOLS TO ASSESS RIVER STATUS AND GUIDE REHABILITATION TO OPTIMIZE RIVER BASIN MANAGEMENT

RESTORE's multiple benefits for river restoration and the ECRR

Baker C

CHRIS BAKER

Wetlands International, The Netherlands.

Chris.baker@wetlands.org

The relevance of river restoration to achieve river management goals and solutions has become increasingly apparent in recent years and become increasingly reflected in policy at European and national level. On the ground there is an ever increasing frequency of projects and initiatives. However, the gap between innovation, best practice, meaningful landscape scale implementation and impacts remains significant. The RESTORE LIFE+ project was a key communications initiative that sought to try and address this across Europe, supporting key networks and actors such as the ECRR and its National Centers. The presentation will reflect on the successes and speculate on the direction that similar initiatives and actors such as the ECRR need to move in the years to come.

Increased river restoration needs societal and political choices based on leadership, courage, cooperation, public participation, (sector) stakeholder involvement. Successful integrated river basin management including basin restoration, as valued by citizens while addressing the pressures, depends on the proper reflection of societal and political choices on sustainable socio-economic development into a realistic and practical planning and implementation framework, based on public participation and stakeholder involvement. Win-win solutions, linking economic gain with adaptation & mitigation of impacts need to be considered, taking uncertainties regarding socio-economic development and climate change into account.

Approaches to consider the recolonisation potential in restoration planning

Dahm V & Hering D

VERONICA DAHM & DANIEL HERING

Aquatic Ecology, University Duisburg-Essen, Universitätsstr. 5, 45141 Essen, Germany.

Abstract

Restoration measures often do not lead to the expected response of fish and benthic invertebrate communities. A prominent reason, beside ongoing impacts, is that sensitive species were eradicated over decades from many catchments. Therefore only a subset of river type specific species is able to recolonise restored river sections. To consider the restoration potential in restoration planning helps to predict restoration success and to prioritize measures. In a project funded by the German Federal Environmental Agency (UBA) we developed an approach to identify source sites of sensitive fish and invertebrate species. We categorized German monitoring data based on the number of sensitive species and conducted statistical modeling (Boosted Regression Trees) with environmental variables. The location of the fish and invertebrate source sites are highlighted in maps. In a next step we developed a method to predict the restoration success of non-restored river stretches in a catchment. The approach is based on deriving the recolonisation potential by estimating the dispersal from the source sites with a cost distance analysis (ESRI ArcGIS Tools), taking dispersal capacities and barriers into account. Further data, e.g. on habitat conditions or nutrient concentrations, can be added to the maps that show river stretches with high, medium or low recolonisation potential. The combination of data allows the identification of river stretches where impacts need to be diminished or habitats need to be created, and to estimate – after the method was applied – if a short term or rather long term success can be expected.

Introduction

One prominent goal of river restoration is to improve ecological status. This aim is defined by legislation, e.g. the EU Water Framework Directive. While the riparian biota react almost immediately to habitat enhancement, aquatic biota such as fish and invertebrates respond less strongly and with a considerable time-lag (Nilsson et al. 2014). The effects of improved habitat conditions are often superimposed by water quality (e.g. Kail et al. 2012), strongly altered hydrologic regimes (Beechie et al. 2010), fine sediment input (Von Bertrab et al. 2013), and the current and former riparian and catchment land use, which acts as an integrating stressor (Dahm et al. 2013; Lorenz and Feld 2013). All these stressors may have affected the river networks for several decades and may consequently have eradicated populations of sensitive species from large parts of the catchments, with only fragmented near-natural stretches remaining (Thomas 2014). Therefore only a subset of river type specific species is able to recolonise restored river sections.

The consideration of recolonisation processes in restoration planning requires knowledge on (i) the location of populations of sensitive species, (ii) dispersal distances and (iii) dispersal pathways. While the migration of fish and hololimnic invertebrates is restricted

to the water body, aquatic insects with winged life stages can disperse along the stream corridor or laterally over land, even crossing catchment borders (Hughes et al. 2007). Within the river network, weirs and stagnant stretches can act as dispersal barriers; for aerial dispersal of insects certain land-use types such as dense coniferous forests or urban areas might obstruct migration. Winking et al. (2014), Stoll et al. (2013) and Sundermann et al. (2011) observed an enhanced recolonisation of restored river reaches by sensitive fish and benthic invertebrate species if source populations were present in a radius of five kilometers. This required maximum distance of source populations to restored river stretches can be seen as a "thumb rule", aggregating species with different dispersal capacities.

For restoration management, sites hosting several sensitive species are of prime interest, as these could greatly influence the assemblages of nearby restored sites. To better account for the recolonisation potential in restoration planning we developed the following approaches:

- (1) a method to identify fish and benthic invertebrate recolonization source sites, based on the analysis of monitoring data from Germany and statistical modeling with environmental data (Boosted Regression Trees).
- (2) an approach to predict the restoration success of non-restored river stretches in a catchment, applying cost-distance-tools of ArcGIS considering dispersal capacities and dispersal barriers.

The results are presented as maps that allow a visual estimate of the recolonisation potential of river stretches that may be suitable for restoration and of restoration success.

Data and Methods

For method (1) we compiled benthic invertebrate taxalists of 5,919 sites located in 12 German federal states and fish taxa lists of 2,584 sites located in six federal states. The data result from monitoring activities performed in the years 2004 to 2010. Benthic invertebrates were sampled following the multi-habitat sampling procedure as described by Haase et al. (2004), fish were sampled according the field method to assess rivers with fish described by Dußling et al. (2014). Sensitive benthic invertebrate species were selected using the stream type-specific German Fauna Index (species with indicator value +1 and +2, i.e. species indicating near-natural conditions; Lorenz et al. 2004). For each stream type, the number of sensitive species per sampling site was plotted against the ecological quality class. The 25 percentile of class 2 (good ecological status) was considered as the threshold for a high number of sensitive species, which are considered as source sites. Sensitive fish species were defined as the river type-specific "guiding species" according to Dußling et al. (2014). The fish-based assessment system fiBS relates the maximum number of guiding species present under near natural conditions to the number of guiding species sampled by calculating the quotient of the number of observed guiding species and the total number of guiding species in the reference community. Sampling sites with a quotient of ≥ 0.7 were considered as source sites.

To identify source sites from river stretches that have not been sampled, we ran Boosted Regression Trees with environmental variables (land use along the river, habitat quality,

elevation, distance to source). For each organism group and river type or river type group, the BRT analysis resulted in a combination of environmental variables and respective thresholds indicating the presence of source sites. Using standard ArcGIS selection tools we selected and exported river stretches meeting these criteria from the entire German river network to identify "potential source sites". These sections were added to maps on federal states` level, together with the known source sites derived from the monitoring data.

The method to predict restoration success (2) was applied exemplarily in the catchment of the river Ruhr, Germany where we had 1,500 macroinvertebrate and 500 fish sampling sites available. The method is applied with common ArcGIS tools and structured as followed:

1. Source sites in the catchment are identified from sampling data according to method (1).
2. The dispersal from the source sites is calculated with a cost-distance analysis. It is determined for different dispersal groups (taxa with similar dispersal capacities) which river stretches can be reached, considering dispersal barriers in the water body / on land.
3. The recolonisation potential of the river stretches is derived by intersecting the results of the dispersal groups.
4. River stretches with good habitat quality are highlighted. This indicates where restoration projects should be located to connect river stretches with good habitat conditions - regardless of whether a low or high recolonisation potential is given.
5. Other stress factors, such as nutrient concentration or acidification can be integrated into the resulting maps.

The combination of data allows the identification of river stretches where impacts need to be diminished or habitats need to be created, and to estimate – after the method was applied – if a short term or rather long term success can be expected.

Results

(1) Identification of source sites

Figure 1 shows the actual and predicted source sites of benthic invertebrates in the federal state Baden-Württemberg, Germany.

(2) Estimation of restoration success

Figure 2 shows river stretches of high, intermediate and low recolonisation potential. River stretches with minimum habitat quality are highlighted.

Legend

Number of sensitive benthic invertebrate species

- ▲ high = source site
- ▲ intermediate
- △ low

Statistical modeling with environmental variables

- Potential source site
- No potential source site
- River stretch not considered in model

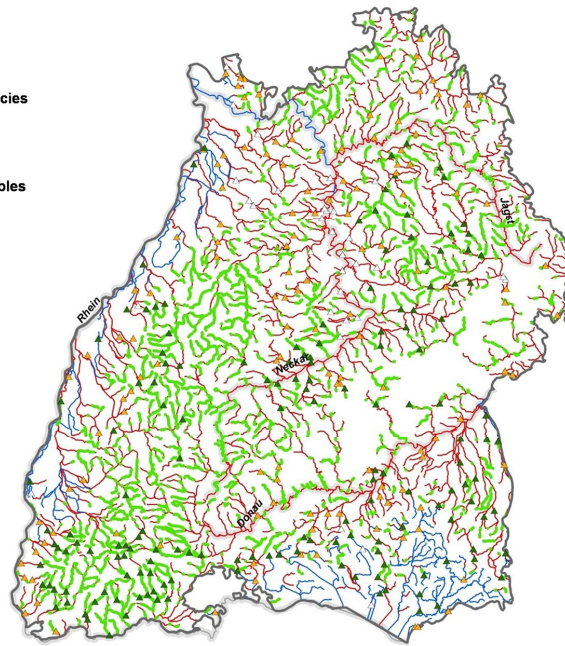

Figure 1. Actual and predicted source sites of benthic invertebrates in Baden-Württemberg, Germany.

Recolonisation potential of benthic invertebrates in the Ruhr catchment

- high
- intermediate
- low
- minimum habitat quality

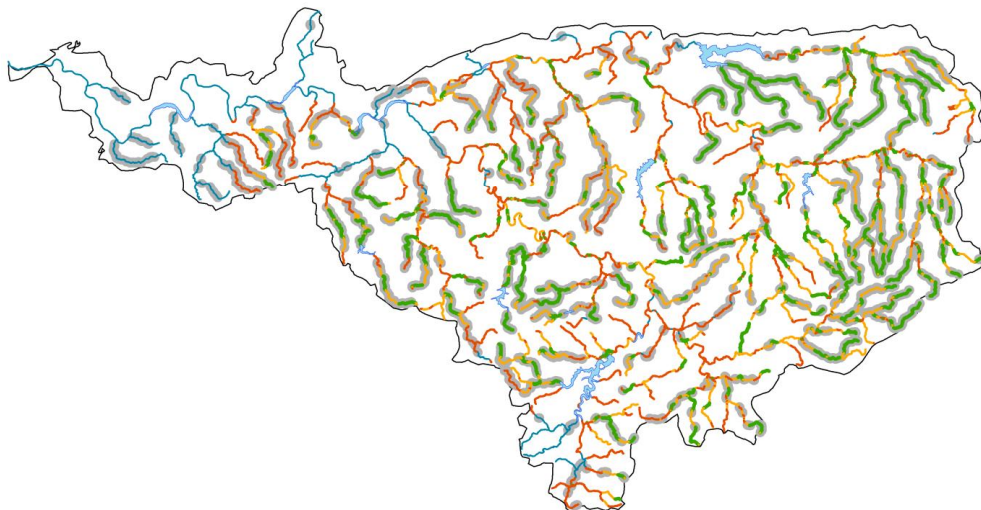

Figure 2. Recolonisation potential of benthic invertebrates in the Ruhr catchment, Germany.

Discussion

Beside the goal to reach good ecological status, the WFD also aims at implementing “all measures to prevent deterioration of the status of water bodies”. Against this background

it is crucial to highlight the location of source sites, i.e. remaining near-natural river stretches in highly fragmented river networks, to protect and, wherever possible, reconnect them to degraded or restored stretches. In restoration planning the knowledge of source sites and the recolonisation potential allows to prioritize measures and to define realistic goals, including an estimation if fast or rather long-term improvements are expected. For method (1), BRTs reliably identified relevant environmental variables for source sites especially in mountainous regions. We used environmental variables that were available for large parts of Germany, which is likely the reason for the lower explanatory power in lowland regions. For lowland regions we advise to use additional parameters such as fine sediment input and conditions of the hydraulic regime, since variables such as the elevation integrating these factors are of little relevance in the lowlands. The Ruhr catchment was used as a model catchment to present the approach for estimation of restoration success (2). The reliability of the derived recolonisation potential depends strongly on the accuracy and resolution of the input data. As many factors as possible that could hinder or prevent dispersal should be taken into account.

References

- Beechie TJ, Sear DA, Olden JD et al (2010). Process-based principles for restoring river ecosystems. *BioScience* 60(3):209-222.
- Dahm V, Hering D, Nemitz D et al (2013) Effects of physico-chemistry, land use and hydromorphology on three riverine organism groups: a comparative analysis with monitoring data from Germany and Austria. *Hydrobiologia* 704(1):389-415.
- Dußling U, Berg R, Klinger H, Wolter C (2014) Assessing the Ecological Status of River Systems Using Fish Assemblages. *Handbuch Angewandte Limnologie: Grundlagen - Gewässerbelastung - Restaurierung - Aquatische Ökotoxikologie - Bewertung - Gewässerschutz*. Wiley-VCH Verlag GmbH & Co. KGaA .
- Haase P, Lohse S, Pauls S et al (2004) Assessing streams in Germany with benthic invertebrates: development of a practical standardised protocol for macroinvertebrate sampling and sorting. *Limnologica - Ecology and Management of Inland Waters* 34(4):349-365.
- Hughes CL, Dytham C, Hill JK (2007) Modelling and analysing evolution of dispersal in populations at expanding range boundaries. *Ecological Entomology* 32(5):437-445.
- Kail J, Arle J, Jähnig SC (2012). Limiting factors and thresholds for macroinvertebrate assemblages in European rivers: Empirical evidence from three datasets on water quality, catchment urbanization, and river restoration. *Ecological Indicators* 18(0):63-72.
- Lorenz AW, Hering D, Feld CK, Rolauuffs P (2004) A new method for assessing the impact of hydromorphological degradation on the macroinvertebrate fauna of five German stream types. *Hydrobiologia* 516(1-3):107-127.
- Lorenz AW, Feld CK (2013) Upstream river morphology and riparian land use overrule local restoration effects on ecological status assessment. *Hydrobiologia* 704(1):489-501
- Nilsson C, Polvi LE, Gardeström J, Hasselquist EM, Lind L, Sarneel JM (2014). Riparian and in-stream restoration of boreal streams and rivers: success or failure? *Ecohydrology*.
- Stoll S, Sundermann A, Lorenz AW, Kail J, Haase P (2013). Small and impoverished regional species pools constrain colonisation of restored river reaches by fishes. *Freshwater Biology* 58(4):664-674.
- Sundermann A, Stoll S, Haase P (2011). River restoration success depends on the species pool of the immediate surroundings. *Ecological Applications* 21(6):1962-1971.
- Thomas G (2014). Improving restoration practice by deriving appropriate techniques from analysing the spatial organization of river networks. *Limnologica - Ecology and Management of Inland Waters* 45(0):50-60.
- Von Bertrab MG, Krein A, Stendera S, Thielen F, Hering D (2013). Is fine sediment deposition a main driver for the composition of benthic macroinvertebrate assemblages? *Ecological Indicators* 24(0):589-598.
- Winking C, Lorenz AW, Sures B, Hering D (2014). Recolonisation patterns of benthic invertebrates: a field investigation of restored former sewage channels. *Freshwater Biology* 59(9):1932-1944.

Semi-automated riverscape units classification and active river channel delineation for the Piedmont region (Italy)

Demarchi L & Bizzi S

LUCA DEMARCHI & SIMONE BIZZI

European Commission, Joint Research Centre, Institute for Environment and Sustainability, Via E. Fermi 2749, I-21027 Ispra, VA, Italy.

Semi-automated procedures based on remote sensing (RS) datasets, allowing a continuous analysis of river systems on wide spatial scales, have a great potential to improve monitoring activities of hydromorphological indices, which can now be estimated in a quantitative rather than descriptive way, more objectively and less exposed to operator subjectivity. An essential step of any fluvial survey is the identification of riverscape units, key features for understanding the hydromorphological status of a river system and for the delineation of the Active river Channel (AC). So far, the concept behind the use of RS for this purpose has been rather simple and mostly based on manual interpretation of visible features on aerial photography.

In this paper, we present a new semi-automated method, based on the use of geographic object-based image analysis (GEOBIA), for the classification of the main riverscape units: bare sediments, pioneer vegetation, forested islands, channel and floodplain. We integrate spectral and topographic information using very high resolution (VHR) imagery and LiDAR-derived products within GEOBIA, along the regional fluvial network of the Piedmont Region (Italy). 265 image tiles were automatically processed: a two-level hierarchical object-based segmentation was produced for each tile. Random Forest and Support Vector Machine classifiers were assessed for a 40km section of the Orco River and used to classify the main river network of the whole region. Results demonstrate the potentials of GEOBIA to efficiently automatizing the procedure, resulting in a 10,000 km² map of riverscape units and AC delineation for the main rivers of the Piedmont Region, obtained in a semi-automated, robust and user-friendly environment. This study is an example of how RS techniques can be exploited to generate continuous and consistent data suitable to support hydromorphological assessment and monitoring of rivers at the regional scale.

Introduction

In this study we exploit the potentials of very high resolution (VHR) near infrared aerial imagery (0.4 m) and LiDAR-derived products for mapping of riverscape units essential for semi-automated Active river Channel (AC) delineation: bare sediments, pioneer vegetation, forested islands, channel and floodplain [1]. According to the definition of [2], the AC includes "*the submerged channel, unvegetated mid-channel islands, chutes and exposed bars*". Besides, [3] defined the TAC as the "*entire channel area and width between the adjacent bank-side vegetation canopy, including the areas of any mid-channel islands and clusters of vegetation*". Mapping riverscape units with a high level of detail along the whole river corridor is therefore fundamental for (1) delineating the AC and TAC, key features for understanding the morphodynamics of a river system and for

(2) potentially understanding the driving forces of islands formation, which depict particular ongoing river processes.

The major challenge consists in distinguishing riverscape units from other landscape features found within the floodplain, due to their spectral similarity (e.g.: sediment bars with bare soil fields or artificial surfaces and vegetated islands with vegetated patches found in the inactive part of the floodplain). While hyperspectral RS has the potential to overcome both issues, the low spectral resolution of the VHR imagery used in this study limits the spectral separability for some of these features [4]. GEOBIA offers new possibilities to enhance this limitation by integrating LiDAR topographic data within the VHR imagery and by grouping connected pixels having similar characteristics into meaningful image objects. Moreover, a broad range of object attributes can be added to the limited spectral domain [5]: statistical summaries of spectral, textural and geometrical features can all be employed in the classification procedures and if powerful classifiers are to be used, such as Machine Learning algorithms, the confusion between spectrally similar land-cover types may be reduced.

Data

During the years 2009/2010, the Regione Piemonte commissioned a flight acquisition campaign to cover the entire region (25,400 km²) with 40 cm near-infrared orthophotos coupled with simultaneous topographic LiDAR data acquired at an average point density of 0.4 point/m², which generated a Digital Terrain Model (DTM) of 5x5m grid cells.

In this study we focused on the biggest 18 rivers of the Piedmont Region. The ArcGIS "*Fluvial corridor*" toolbox proposed in [6] was adopted in this study for the delineation of the Valley Bottom, defined as the modern alluvial floodplain by [7]. The "*Fluvial corridor*" toolbox was also employed for the calculation of the Detrended Digital Terrain Model (DDTM), by using the river centerline shapefile and the DTM for the whole region. The DDTM is an important input data because it represents the elevation of all floodplain features compared to the river network, and if well employed it could be essential in distinguishing different geomorphic features.

All analysis performed in this study are focused within the boundaries delineated by the Valley Bottom shapefile, which resulted in a total of 265 image tiles to be processed within the Piedmont Region.

Methodology

In this study, we aim to use GEOBIA to enhance the limited spectral resolution of VHR imagery to classify riverscape units. GEOBIA allows to combine the LiDAR topographic data with the VHR imagery and to test the different object features calculated from the two different sources of RS data. The entire object-based methodology was developed within eCognition Developer 9 software. The first step is the generation of meaningful objects from the RS data, i.e. image segmentation. In this work, we adopt a hierarchical segmentation strategy, based on different inputs of RS data for the generation of objects: the first level is produced with the multiresolution algorithm, by using the Slope layer alone, obtained from the LiDAR topographic data (Level 1, Fig.1). The second level of the segmentation (Level 2, Fig. 1) is produced in a similar way with the multiresolution segmentation but using the VHR spectral layers available, equally-weighted: Green, Red and Near infrared spectral bands plus NDVI. This way, it was possible to generate image

objects of different spectral characteristics within bigger objects having homogenous slope characterization.

A Machine Learning object-based classification was then performed on Level 2 (Fig. 1). In order to properly develop the classification methodology, in a first phase we focused only on 40km of the Orco river section. Within this relatively small part of the Piedmont Region, sample objects were collected manually for each riverscape units class on the Level 2 segmentation, based on visual interpretation of VHR imagery. This resulted in two sets of randomly and spatially distributed training and validation objects. Random Forest (RF) and Support Vector Machine (SVM) algorithms were trained and validated using different combinations of input features sets. From the VHR imagery, ten "VHR features" (1) were extracted for each training object (e.g.: mean and standard deviation of the four spectral layers, plus Brightness and Max difference). From the LiDAR-derived products, we grouped the mean and standard deviation of the DTM and Slope layers under the "LiDAR features" group (2), while the mean and standard deviation of the DDTM layer was kept apart under the "DDTM features" group (3). Fifteen "Geometrical features" (4) and twelve "Texture features" (5) were also calculated. Validation objects were used for the accuracy assessment, based on Kappa values and per-class producer accuracy comparison, with the aim of identifying which group of features produced the highest classification accuracies in mapping riverscape units.

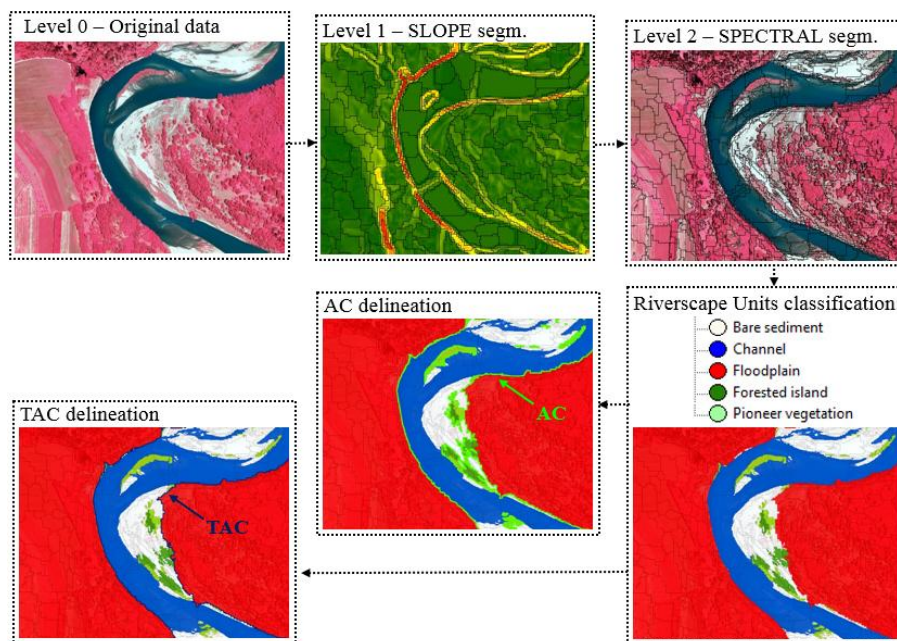

Figure 1. Workflow of the hierarchical object-based methodology developed for the classification of riverscape units.

The Orco River classification map with the highest Kappa accuracy was then used as a sampling source for the training of a new classifier to be used for the classification of the main river network of the Piedmont Region.

The hierarchical two-level segmentation procedure was therefore run for the 265 image tiles, within the Valley Bottom boundaries of the 18 main rivers of the Piedmont Region.

Objects were classified at the level 2 segmentation for the entire network with the new classifier, resulting in 10,000 km² semi-automatic mapping of riverscape units.

Results

Figure 2 shows the Kappa accuracies resulting from RF and SVM when classifying different combinations of input features sets for the Orco River. The most striking result is that when using the “DDTM features” (3) in combination with the “VHR features” (1), both classifiers produced the highest accuracies: 0.91 for SVM and 0.89 for RF. Whereas, when using both “LiDAR features” and “DDTM features” together with the “VHR features” (groups 1, 2, 3), the accuracies are slightly lower (0.88 form SVM and 0.85 for RF), underlying the importance of the “DDTM features”. These results evidence the importance of the DDTM layer: mean and standard deviation of this layer calculated for each object and combined with mean and standard deviation of other spectral layers are sufficient to generate the highest Kappa accuracy when classifying riverscape units for the Orco River. The DDTM layer is more important than “Geometrical features” and “Texture features” calculated by the eCognition software. These results underline at the same time the sensibility of the classifiers tested to the type of features used, rather than the number of features used. The Orco River dataset (187226 objects) classified by SVM with the “DDTM features” and “VHR features” was then used as a training dataset for the generation of a more powerful classifier to be used for the classification of the main river network of the Piedmont Region. Figure 3 shows examples of the classification results obtained for different river types mapped within the Piedmont Region. A visual assessment of the results demonstrated the method’s capability of automatically distinguishing riverscape units from other landscape features in different geographical and morphological conditions.

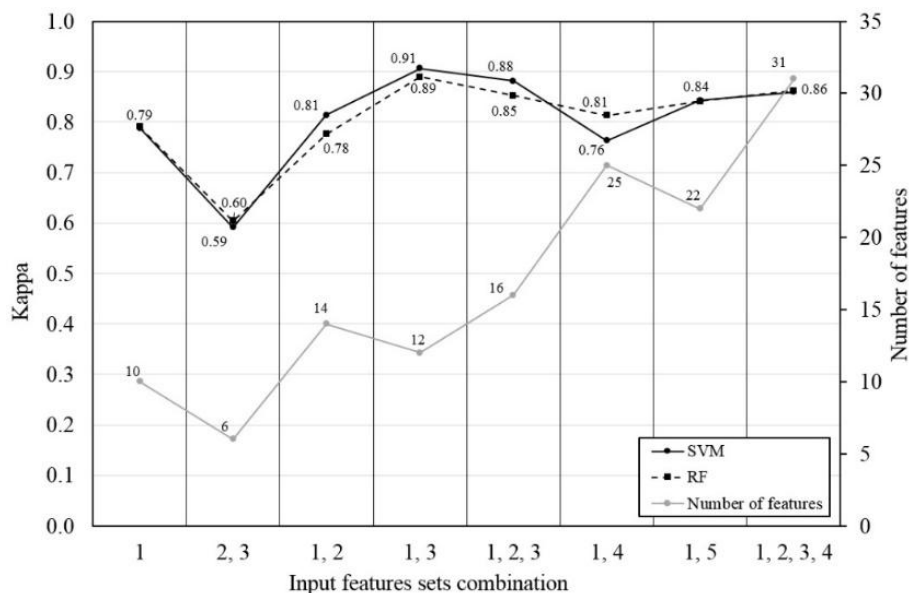

Figure 2. Riverscape units classification results obtained when testing different input features sets combination with SVM and RF (1=VHR features, 2= LiDAR features, 3= DDTM features, 4= Geometrical features and 5= Texture features).

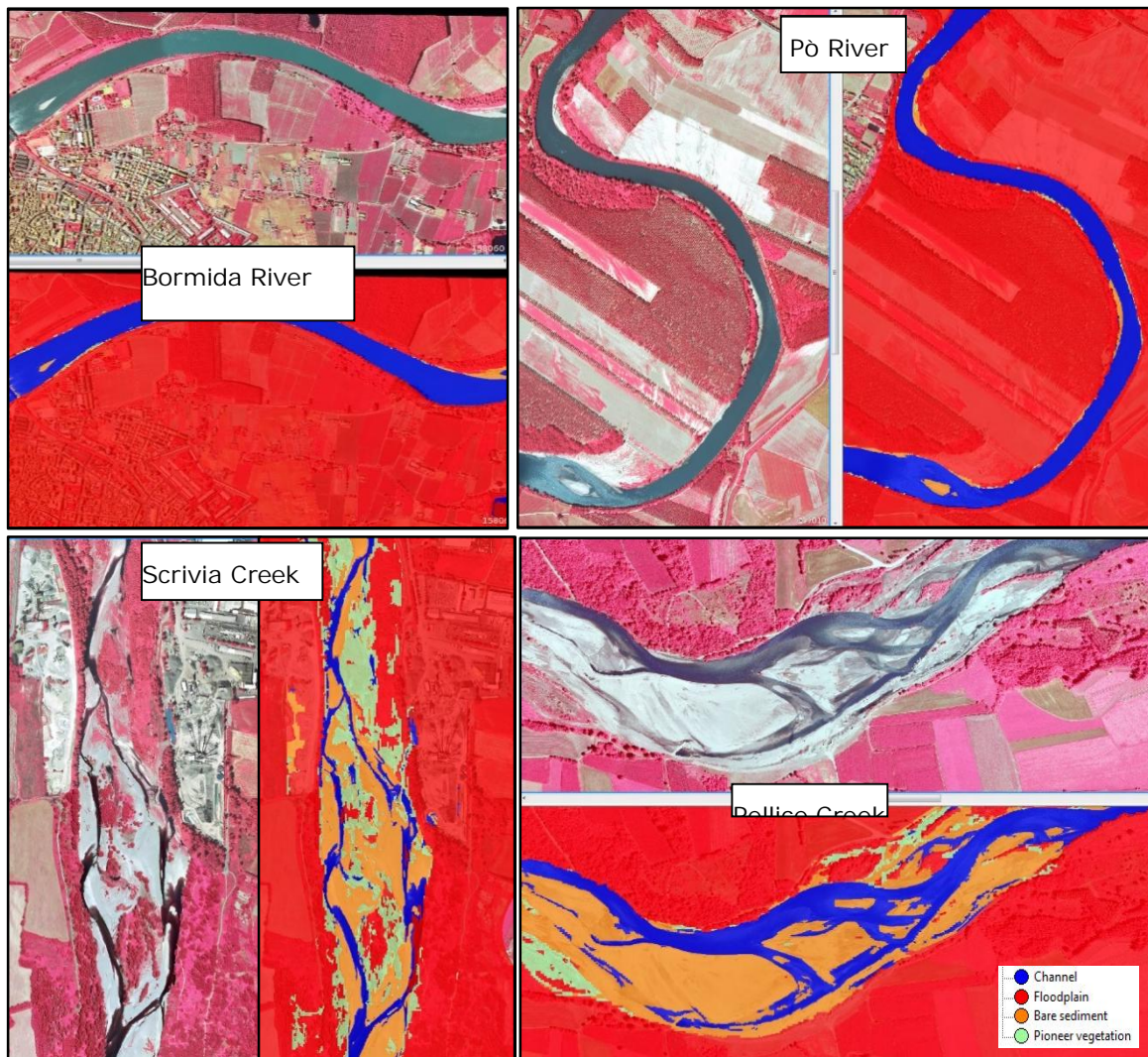

Figure 3. Examples of riverscape units classification results obtained for different river sections of the Regione Piemonte river network.

Conclusions

In this study, the aim was to exploit the potential of GEOBIA in combining sub-meter VHR imagery with LiDAR topographic data for mapping riverscape units at the regional scale, for the Piedmont Region (Italy). A hierarchical object-based approach was developed to integrate the two different sources of RS data. By combining "VHR features" and "DTM features" within SVM classifier, it was possible to distinguish riverscape units from other landscape features (i.e.: bare sediments from bare soil fields or artificial surfaces) with a high level of accuracy for 10,000 km² of the Piedmont Region, which is characterized by river types of different hydromorphological status. The classification results were assessed only for the Orco River, which resulted with a Kappa accuracy of 0.91. For the other rivers of the region, the visual interpretation of the results is very promising. A groundtruth sampling collection for the whole region based on visual interpretation of VHR imagery is in progress, allowing in the near future a more precise assessment of the method.

This work is an example of how RS data can be used to extract some of the hydromorphological indicators (at large scales and with a high level of detail), suggested by the REFORM Hierarchical Framework [8] and required for a proper hydromorphological characterization of river systems. Of particular relevance is the availability of similar RS datasets throughout most European Member States [9]: in the future, this methodology might be applied at wider scales and the use of RS techniques in support of hydromorphological characterization implemented more consistently. GEOBIA, combined with Machine Learning SVM classifier proved to be an advanced image analysis technique for this purpose, able to integrate and exploit the potentialities of two contemporary high-resolution RS datasets in a semi-automated, robust and user-friendly environment.

References

- Belletti, B.; Dufour, S.; Piégay, H. What Is the Relative Effect of Space and Time To Explain the Braided River Width and Island Patterns At a Regional Scale? *River Res. Appl.* 2013.
- Marcus, W. A.; Fonstad, M. A.; Legleiter, C. J. Management Applications of Optical Remote Sensing in the Active River Channel. In *Fluvial Remote Sensing for Science and Management*; Carbonneau, P.; Piégay, H., Eds.; Chichester, UK, 2012; pp. 19–42.
- Toone, J.; Rice, S. P.; Piégay, H. Spatial discontinuity and temporal evolution of channel morphology along a mixed bedrock-alluvial river, upper Drôme River, southeast France: Contingent responses to external and internal controls. *Geomorphology* 2014, 205, 5–16.
- Herold, M.; Roberts, D. a; Gardner, M. E.; Dennison, P. E. Spectrometry for urban area remote sensing—Development and analysis of a spectral library from 350 to 2400 nm. *Remote Sens. Environ.* 2004, 91, 304–319.
- Hay, G. J.; Castilla, G.; Wulder, M. A.; Ruiz, J. R. An automated object-based approach for the multiscale image segmentation of forest scenes. *Int. J. Appl. Earth Obs. Geoinf.* 2005, 7, 339–359.
- Roux, C.; Alber, A.; Bertrand, M.; Vaudor, L.; Piégay, H. "FluvialCorridor": A new ArcGIS toolbox package for multiscale riverscape exploration. *Geomorphology* 2014.
- Alber, A.; Piégay, H. Spatial disaggregation and aggregation procedures for characterizing fluvial features at the network-scale: Application to the Rhône basin (France). *Geomorphology* 2011, 125, 343–360.
- Gurnell, A. M.; Rinaldi, M.; Belletti, B. A multi-scale hierarchical framework for developing 508 understanding of river behaviour to support river management. *Acquat. Sci.* 2015, (accepted).
- Bizzi, S.; Demarchi, L.; Grabowski, R.; Weissteiner, C.; Van de Bund, W. The use of remote sensing to characterise hydromorphological properties of European rivers. *Acquat. Sci.* 2015, (accepted).

European Centre for River Restoration and River Restoration through the years!

Fokkens B

BART FOKKENS

Chairman and co-founder of the ECRR

wetlandmanplanet.nl

The European Centre for River Restoration is a Greater European Network with 15 national centres and river restoration organisations as members or partners and has about 800 organisational and individual subscribers of the newsletter and other products of the ECRR. The ECRR disseminates river restoration information, supports the development of best practices of river restoration and connects therefore people and organisations working on river restoration.

The ECRR was initiated in 1996, established in 1999 as a loose network and became an association in 2014. The ECRR worked together in close collaboration with the RESTORE project, which ran between 2010 and 2013. Some of the key outputs of this project are the RiverWiki, a Laymans report, setting out future directions and the guide, Rivers by Design, for planners. The ECRR organised over the years 6 European / International River Restoration Conferences of which the last two featuring the awarding of the first and second IRF European Riverprize.

The presentation will describe the development of the ECRR in relation to the results of implemented river restoration and river basin management initiatives, addressing various themes as urban resilience, sustainable land use and ecological & economical benefits, confirming the significant progress made in shifting from the science & ecology focus on the local level towards integrated, cross-sectoral policy and planning practices over regions and basins.

Demonstrated value of a focused exchange of knowledge and experiences between involved sectors encourages river restoration practitioners to expand the practical application of innovative approaches and instruments in contributing to holistic considerations of maintaining natural river processes, by aligning sustainable socio-economic development planning through considerations for the multiple benefits from ecosystem services & natural values.

The impacts from known, underestimated as well as new, unexpected pressures on rivers and aquatic ecosystems remain significant. Addressing these impacts with sustainable integrated river basin management approaches requires the strengthening of cross-cutting planning and implementation, between countries & basins, sectors & themes, policy & legislation, stakeholders and the public.

Successful integrated river basin management, as valued by citizens depends on the proper reflection of societal choices on sustainable socio-economic development into a realistic and practical planning and implementation framework as the EU Water

Framework and other Environment Directives, based on public participation and stakeholder involvement.

Summary of the discussion at the conference.

The ECRR at first functioning as an informal network has now formed the ECRR Association, an independent not-for profit organisation supporting the wider network of about 800 of individuals, institutions and organisations, including about 10 National River Restoration Centres. What is ECRR's ambition for the future? ECRR's objectives are to enhancing river restoration by promoting ecological river restoration as an integral part of sustainable river basin management and to disseminate river restoration information, supporting best practices, by connecting people and organisations. The most important part of the development was and is to foster National Networks or Centres for river restoration and ECRR understands its role to be a catalyst for information and to give and receive valuable hints and input on how to implement river restoration. Furthermore the external institutional strategy for the coming years strives for consolidation, organizational stability and continuity – based on these assumptions ECRR defined its ambitions to be taken as follows; 1. Strengthening and extending the network, and striving towards better collaboration (both within the network and to the outside world); 2. Strengthening / building up donor-relations; The REFORM session participants strongly endorse this strategy.

What will / can ECRR do on involving private sectors envisages establishing a constant and serious dialogue with private sectors represented by their activities along rivers. ECRR advises the private sector by offering opportunities for communicating about their products and services and possible links to river restoration. A key activity foreseen for the next conference with participation of 4 private sector representatives, e.g. hydropower companies, navigation, forestry and water utilities companies. The conference themes relate to actual river management practices focusing on economics and business of water. These topics will be discussed in combination with supply chain, in company and marketing water issues for developing processes and principles for best practices of river basin management.

Session participants consider public participation essential for successful river restoration and recommend ECRR to produce information materials for this audience. It is foreseen that in the coming years video documentaries and online animations will be produced in ongoing projects on river restoration in order to show best practice examples online and accessible for everybody. The goal is to make theoretical concepts of river restoration more understandable to practitioners (mostly in English language, but also in other languages).

The (RESTORE) Riverwiki is by most of the participants know but not always used. The ECRR wants to geographically enlarge its sphere of interest by adding further case studies, in particular from countries which are underrepresented by now. Links with other Wiki's like REFORM and NWRM would be appreciated by the audience.

A well-known format of transferring information and influencing policy makers are so-called Round Tables. ECRR could invite a group of national Government representatives, the EU Commission, experts, etc.. to discuss the most recent developments in both water

policy and management and river restoration. Round Tables have been organized within the RESTORE project with good results and feedback.

In conclusion: (Financial) support to the ECRR Association and Network for the subject of river restoration helps to foster the exchange of best-practice and helps to avoid redundant research and study work. River restoration projects at regional or local level normally do not provide funds for capacity building and training purposes at international level.

Towards an harmonized understanding of mitigation measures and implementation thereof to reach Good Ecological Potential (GEP) in water bodies impacted by Water Storage across Europe

Halleraker et al.

JO HALVARD HALLERAKER¹, WOUTER VAN DE BUND², MARTINA BUSSETTINI³, SEBASTIAN DÖBBELT-GRÜNE⁴, JANINE HENSMAN⁵, JOHAN KLING⁶, VERONIKA KOLLER-KREIMEL⁷, PETER POLLARD⁸

¹Norwegian Environment Agency, Norway, ²European Commission, Joint Research Centre, Italy, ³Institute for Environmental Protection and Research, Italy, ⁴Planungsbüro Koenzen, Germany, ⁵UK WFD Technical Advisory Group (UK-TAG), Scotland, ⁶Swedish Agency for Marine and Water Management, Sweden, ⁷Lebensministerium, Austria, ⁸Scottish Environment Protection Agency, Scotland.

The intercalibration exercise according to the Water Framework Directive (WFD Annex V) has been essential for a Common Implementation Strategy (CIS). Its objective is to harmonise the understanding of 'good ecological status/potential', and to ensure that this common understanding is consistent with the definitions of the Directive. A more harmonized understanding of Good Ecological Potential (GEP) has been in focus since 2013. A core group of water managers is presently compiling a report outlining good practise on deciding what GEP is and evaluating the best available mitigation measures for impacted HMWBs from water storage.

Introduction

Hydromorphological alteration (hymo) and over-abstraction of water in particular, are found to be the second most common pressures on ecological status in the EU (EU Blueprint for Water). The official CIS approach (WFD CIS, 2003) defines good ecological potential (GEP) based on the biological quality elements. Since 2005, a number of CIS workshops have led to key conclusions and recommendations for best management practice for hymo issues (available at [CIRCABC](#)). The Prague or the mitigation measure approach was agreed at one of these workshops in 2005 as a valid method for defining GEP (Kampa and Kranz, 2005). Both state that GEP is not a "stand alone" object, but is based on the mitigation measures comparable with the use. It was therefore proposed to develop lists of relevant mitigation measures along with estimations of their effectiveness.

As one of the core activities for the CIS working group on Ecological Status (ECOSTAT) from 2013, a harmonized understanding of GEP for HMWBs has been on the agenda. An ad-hoc group has been working on harmonizing GEP related to water storage, consisting of national experts on hymo issues and coordinated by a core group (the authors of this paper). Typical hymo alterations and ecological impacts considered are illustrated in Figure 1.

Several information exchange templates have been circulated between Member States and EEA countries to exchange data on ecological indexes sensitive to hymo, available mitigation measures and approaches to define GEP in relation to water storage. Workshops based on the template results have been arranged to clarify terms and definitions, highlight where there is alignment, and where there are differences in

approaches, to start to explore the reasons behind these. Presentations and documents related to the group's work are available on [CIRCABC](#). The aims have been to exchange experience on good ecological potential (GEP) and hyno alterations caused by water storage, learn from each other to ensure common understandings and to define best available mitigation measures for heavily modified water bodies due to water storage across Europe.

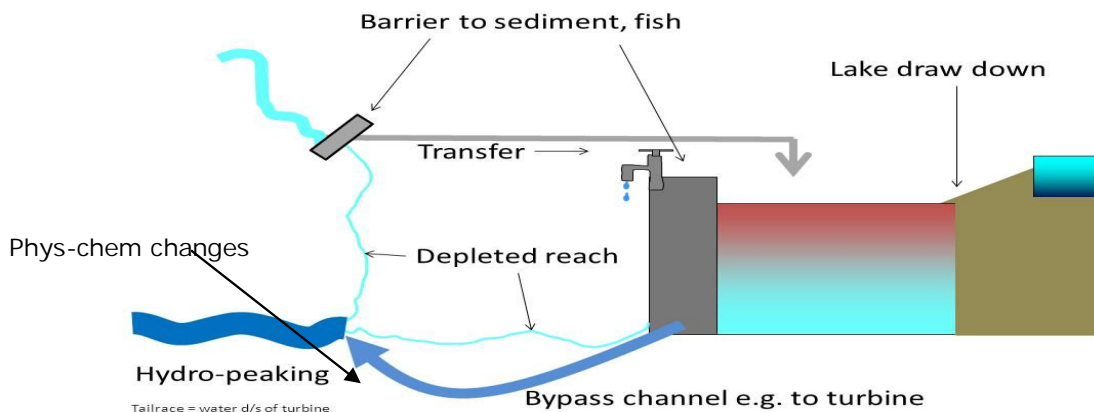

Figure 1. Typical hydromorphological alterations giving ecological impacts to water bodies from water storage (for hydropower, drinking-water supply, irrigation or other equally important sustainable activities as stated in Article 4.3 of WFD).

European questionnaires' on mitigation measures in use

An essential component of the work on harmonizing the understanding of good ecological potential for water bodies impacted by water storage has been information exchange templates to collect and compare data.

An information exchange template was circulated to Member States to gather information on national measures available to a country for mitigating ecological impacts from water storage pressures, and how these measures are used. Measures were grouped into 10 key mitigation measures based on the types of water affected (e.g. rivers upstream or downstream of structures), water use (e.g. water storage hydropower, water storage drinking water, run-of-river hydropower) and pressure (e.g. dam, abstraction), see Table 1. In a series of Excel worksheets, information was requested on 1) how the mitigation measures are used (is there a formal process and clear criteria in place for not including the measure, or is it left to local discretion?); 2) the significant impact on use test; 3) evaluation of GEP (HMWB) vs GES (natural water body) for water bodies affected by water storage.

Table 1. An overview of the most widespread key measure to mitigate water storage.

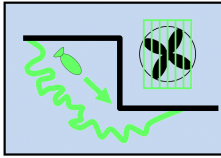
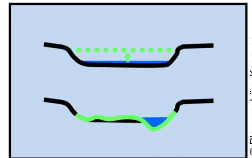
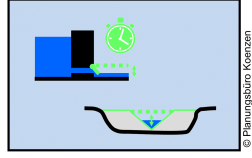
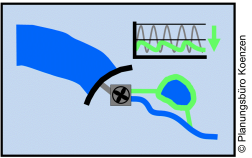
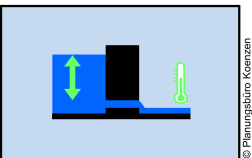
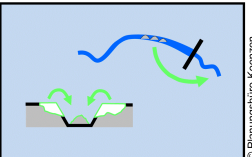
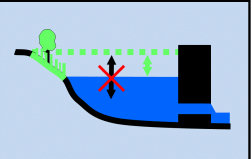
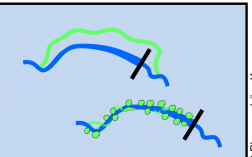
Hydromorphological alteration	Ecological impact	Mitigation measure for	Abb.	Pictogram
River continuity for <u>upstream</u> fish migration reduced or interrupted	Fish: Populations of migratory fish absent or abundance reduced	Upstream continuity for fish	CON 1	
River continuity for <u>downstream</u> fish migration reduced or interrupted	Fish: Populations of migratory fish absent or abundance reduced	Downstream continuity for fish	CON 2	
Artificially extreme <u>low flows</u> or extended low flows	Reduced abundance of plant & animal species. Alterations to composition of plant & animal species	Low flow	FLOW 1	
Loss of, or reduction in, <u>flows sufficient to trigger</u> & sustain fish migrations	Migratory fish absent or abundance reduced	Fish flow	FLOW 2	
Loss, reduction or absence of <u>variable flows</u> sufficient for flushing	Alteration/reduced abundance of fish & invertebrate species	Variable flow	FLOW 3	
<u>Rapidly changing flows</u> (including hydro peaking)	Reduction in animal & plant species abundance due to stranding & wash out	Hydro peaking	FLOW 4	
Alteration of <u>general physico-chemical conditions</u> downstream (e.g. temperature, super saturation etc.)	Altered composition or growth of macro invertebrate communities and fish or fish mortality	Physico-chemical alteration	PHYS-CHEM	
River continuity for <u>sediment disrupted</u> or reduced leading to changes in substrate composition	Reduction in fish & invertebrate abundance & alterations in species composition	Interrupted sediment movement	SED	
Artificially extreme <u>changes in lake level</u> , reductions in quality and extent of shallow water & shore zone habitat	Reduction in abundance of plant & animal species. Alterations to species composition	Lake level	LEVEL	
Dewatered shore line and reduced river flow – <u>ponded river</u>	Alterations to plant & animal species composition (e.g. favouring disturbance-intolerant species/still water species)	Ponded river flow	POND	

For each of the 10 key mitigation measures, national experts were asked to indicate which of the ecological impacts are recognised and addressed by mitigation in the country's lists of mitigation measures, which mitigation measures must be in place to achieve GEP (as long as ecological impact is significant), whether there can be exceptions, and if so, the common reasons for these. A considerable number of sub measures exist in Europe to mitigate the same main impact from water storage. E.g. interrupted continuity for fish may in some countries be mitigated by a fish pass, by-pass channel, catching and transporting fish, a fish ramp or fish stocking. Where there are multiple mitigating measures within a country's measures library, experts were asked to fill in a ranking (sub-measure hierarchy) to differentiate between 1st, 2nd, 3rd choice etc., according to use, ecological effectiveness and effect on water use.

In total, 21 European countries implementing the WFD filled in all or part of the template for their country. In addition, four countries have responded that they could not fill in the template due to pending issues e.g. mitigation measure library still under development. Six countries have not responded to our last template and thereby not contributed to a more common understanding.

Results

An overview of the most widely used key mitigation measures for defining GEP are given in Table 2. More than 50 % of countries are typically requiring at least one measure to mitigate CON 1 and 2, FLOW 1 and 2 where impacts are relevant to HMWBs. Less than half of countries require the other measures. However, several countries are lacking measures for mitigating relevant impacts of water storage such as SED, CON 2, FLOW 3, POND and PHYS-CHEM.

Table 2. Ranking of implemented measures in Europe to mitigate water storage and ensure good ecological potential in impacted water bodies; preliminary findings after responses from 21 European countries.

Key mitigation measure	Abb	Yes	No need for this impact	No relevant measure available	No answer	% yes
Upstream continuity - fish	CON 1	18	2	1	0	86 %
Low flow	FLOW 1	14	4	2	1	67 %
Downstream continuity - fish	CON 2	13	3	4	1	62 %
Variable flow	FLOW 3	11	5	4	1	52 %
Fish flow	FLOW 2	10	8	2	1	48 %
Lake level	LEVEL	10	7	2	2	48 %
Hydro peaking	FLOW 4	9	7	3	2	43 %
Interrupted sediment movement	SED	9	6	5	1	43 %
Ponded river flow	POND	8	7	4	2	38 %
Alteration of physico-chemical conditions	PHYS-CHEM	6	9	4	2	29 %

An example of conclusions reached for CON1 and 2 based on the information exchange analysis and workshop discussions is shown in Table 3. Based on responses from 21 European countries, impact on fish continuity from water storage is the most widespread impact to be mitigated, upstream continuity in particular. However, several countries are lacking mitigation measures for downstream continuity.

Table 3. Example of conclusion – mitigation for fish continuity.

Inclusion in national libraries	<ul style="list-style-type: none"> Nearly all countries (90 % for upstream, ca 70 % for downstream) Upstream and downstream continuity important
Scale of impact addressed	<ul style="list-style-type: none"> Variable depending on ecological importance Typically around 1 to 2 km (range 0.5 to 10 km)
Emerging good practice	<ul style="list-style-type: none"> Bypass channels, lifts, ladders Fish ramps possibly for smaller dams Screens if risk of entering turbines Trap/release or stocking if other options not feasible
Expected frequency	<ul style="list-style-type: none"> Normally expected
Main reasons not required	<ul style="list-style-type: none"> Natural barriers to fish No fish habitats Downstream continuity - uncertainty about impact on non-migratory fish

Typical reasons for measures not being required

The results in Table 2 show that several impacts from water storage are not considered as relevant in many countries, such as FLOW 3 and TEMP. The most common reasons for not requiring mitigation measures are not fully understood, as this part of the template was often not completed by many countries. Still, "technical solution not possible in some sites" seems to be among the most widely used reasons for not implementing measures, typically for mitigating continuity for fish. Significant adverse impact on water use (mainly hydropower) is a common reason for ruling out some measures, even though only a minority of countries have a framework of criteria for deciding upon "significant adverse effect on hydropower or water supply" as a basis for ruling out mitigation measures.

Other criteria for ruling out measures specified in the WFD, due to either significant adverse impact on the wider environment or disproportionate costs, are less common. However, for several measures, some countries have responded that it is too early to say the expected frequency of measure use.

Way forward in the GEP harmonising process

Hymo alterations are among the dominating impacts on water bodies in Europe, and associated designations of HMWB are widespread across many River Basin Management Plans in Europe. Ecological flows related to WFD have been defined recently, and thereby flow needs together with other measures to achieve GES (WFD CIS, 2015).

A common understanding of key principles of the WFD is essential to ensure a comparable implementation of the directive. Therefore, harmonization of GEP for HMWBs is among the core activities in the 2013-2016 work plan for the ECOSTAT Working Group.

In the GEP harmonization process we are trying to 1) compare common standards for GEP, 2) the process for deciding what GEP is, and 3) exploring reasons for selecting/excluding mitigation measures giving significant ecological improvements. This

will be based on the information exchange results of how measures are used to mitigate impacts from water use relevant for HMWBs, with focus on water storage in all countries where this is relevant.

The core group are currently drafting a report on the harmonisation of GEP, which will link to WFD CIS (2003), and results and conclusions from the Flood Protection and Drainage Group will be included. The plan is to have this report ready for the autumn ECOSTAT meeting, to give recommendations of good practice for GEP to the European Water Directors by the end of 2015.

References

- Kampa, E. & Kranz, N. 2005. WFD and Hydromorphology, European Workshop, 17-19 October 2005, Prague. CIS Workshop summary report.
- Kampa, E. & Laaser, C. 2009. Heavily Modified Water Bodies. [Updated Discussion Paper, Common Implementation Strategy Workshop, Brussels, 12-13 March 2009.](#)
- Kampa et al. 2011. Water management, Water Framework Directive & Hydropower CIS Workshop, Brussels, 13-14 September 2011. [Issue Paper \(final version\).](#)
- WFD CIS. 2003. [CIS guidance no 4.](#) Identification and Designation of HMWB and AWB.
- WFD CIS. 2015. [CIS guidance no 31.](#) Ecological flows (Eflows) in the implementation of the WFD.

Assessing alternative conservation strategies for the anastomosing River Narew

Marcinkowski P, Grabowski R C & Okruszko T

PAWEL MARCINKOWSKI¹, ROBERT C. GRABOWSKI², TOMASZ OKRUSZKO¹

¹*Department of Hydraulic Engineering, Warsaw University of Life Sciences, Nowoursynowska 159, 02-776, Warsaw, Poland*

²*Cranfield Water Science Institute, Cranfield University, Cranfield, Bedfordshire, UK MK40 0AP.*

In this study the hierarchical hydromorphological assessment framework developed by the REFORM project (Gurnell et al. 2014) is applied to the river system to develop a process-based understanding of hydromorphological interactions and responses. In particular, the study documents changes in the number of channels (i.e. anabranches) within the NNP over time and explores the human interventions and pressures that may have produced them. This understanding underpins a conceptual model of channel adjustment in response to human intervention, which is used to discuss the likely evolutionary trajectory of the anastomosing section under four different management options. Results show that the response of the fluvial system is very slow and the most suitable solutions to prevent the further anabranches extinction is combination of artificial and natural activities.

Introduction

Anastomosing, multichannel rivers would have been very common in low-gradient, alluvial valleys across European continent and worldwide. Development of such system is controlled by the avulsion process which is "the diversion of flow from an existing channel onto the floodplain, eventually resulting in a new channel belt" (Makaske, 2001). Despite the lack of universal conditions describing the driving forces of avulsion, mutual factors triggering the process across the world can be identified. Among them: the very low stream slope, occurrence of high water stage exceeding eventually bankfull discharge and local flow disturbances caused by blocking structures (woods, vegetation). Rapid agricultural development and urbanisation expansion in 19th and 20th century, triggered extensive modifications of rivers and their floodplains by humans, which caused a significant alterations in geomorphology of fluvial systems, resulting in extinction of anastomoses. In addition the development of transportation required constructing spanning structures crossing the floodplain causing its discontinuity and closing the flow for part of the side channels. Presently the only preserved example of anastomosing type of river in Europe is in the upper River Narew, NE Poland. This section was embraced by formal protection in 1996 through the creation of the Narew National Park (NNP).

The uniqueness of the River Narew determines the importance of preservation which requires an elaboration of protection strategies necessary in maintenance of the anastomosing system. Conservation strategies are mainly focused on preventing the closing and overgrowing the side channels, management of water release and vegetation growth and redirection of flow from main channel to side channels. Among them

following can be found: new water management on Siemianówka Reservoir, creation of minor dams on the channels to redirect a part of the flow into side channels, dredging the inlet part of side channels and organised mowing schedule (NNP Protection Plan, 2014).

The aim of the study is to identify hydromorphological pressures on the River Narew within the national park and to assess their impact on the anastomosing planform to inform future management plans.

Case study

The River Narew is a lowland, low-gradient river situated in north-east Poland (Figure 1), a right-hand tributary of the River Wisła, with a total drainage area ca. 75 000 km². The study focuses on the upper catchment extending from the border with Belarus down to the town of Tykocin (53°12'31"N 22°45'54"E), and specifically on the existing anastomosing section between Uhowo and Łupianka Stara (ca. 5 km). Within the NNP, the river is characterized by a network of small interconnected channels within an unconfined valley (1 - 4 km wide) and bounded by low hills of glacial tills. The channels have a low width/depth ratio, a mobile sand bed and erosion-resistant peat banks (Gradziński et al., 2003). Vegetation cover within the NNP is predominantly early growth reed and sedge communities, which have long been managed for reed harvesting (Banaszuk et al., 2004). Peat deposition has occurred throughout the Holocene and peat deposits within the valley can reach 4 m in thickness (Gradziński et al., 2003).

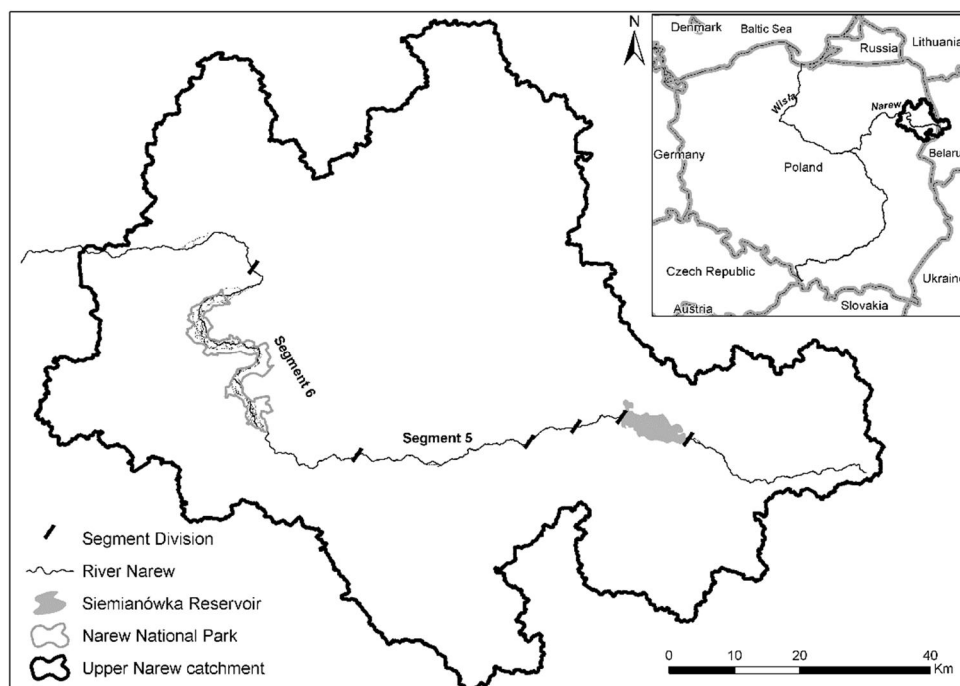

Figure 1. Case study location.

Materials and methods

Comprehensive and hierarchical hydromorphological assessment developed in the REFORM project was applied in this study (Gurnell et al. 2014). This paper forms part of a large hierarchical assessment of the upper Narew catchment involving stage of delineation (detailed description omitted) and detailed characterisation of hydromorphology at a range of spatial scales. The main subject of the interest is existing anastomosing segment of the river within NNP – upstream part.

In order to apply the method an assemblage of remote sensed data and national datasets was required at various scales. Among the gathered data following can be found: a composite Digital Elevation Model (DEM) created using the SRTM (Shuttle Radar Topography Mission, 80m resolution) and elevation maps from Main Geodetic and Cartographic Documentation Centre (5m resolution); a digital map (1:500,000 scale) of the bedrock obtained from the Polish Geological Institute – National Research Institute; The CORINE Land Cover 2006 (CLC2006) dataset (General Inspectorate of Environmental Protection); mean daily discharge records for 2 gauging stations and daily sum precipitation records for 21 stations for years 1951-2012 (Institute of Meteorology and Water Management – National Research Institute); PESERA soil erosion model (Joint Research Centre (EC)); vegetation map (Narew National Park); monthly measurements of total suspended sediment (TSS) in one gauging station (Province Inspectorate of Environmental Protection in Białystok); aerial imagery (<http://geoportal.gov.pl>), historical maps – 1:300 000, 1:100 000 (Polish Military Institute of Geography).

Data assemblage was used for spatial analyses at stage of delineation the units i.e. catchment, two landscape units, seven river segments and 35 river reaches. Characterisation stage included the units within which anastomosing reaches were found. Given the hydromorphological uniqueness and ecological value of the area and the ongoing extinction risk of the fluvial system a detailed investigation was carried out for section of the river within NNP – upstream part.

Summary of temporal changes

Alterations of external conditions resulting from either human activities or natural processes were investigated through the decades at various spatial scales. Partially the parameters were deemed as constant or non-relevant change and some of them were assumed as having a meaningful impact due to the range and magnitude of alteration. Among the significant key controlling factors following can be found: area of large surface water bodies, flow regime, riparian vegetation structure, artificial spanning structures and cessation of local activities (fisheries, farmers). Creation of Siemianówka Reservoir had a significant impact on the flow regime due to particular water release management adjusted for economic, touristic and flood purposes of nearby agglomeration. As a result of mitigation of high flows and inundation duration and additionally cessation of mowing, an uncontrolled expansion of reed caused the effect of closing the dry anabranches by vegetation and their slow extinction. Construction of a bridge, crossing the valley caused its discontinuity and limitation of the lateral mobility of anabranches. Also cessation of activities of local farmers and fishermen such as damming the water using woods and rocks to catch fish and run water mills was very meaningful for the fluvial system. It was reported in historical papers that the number of such dams on the side channels in the region exceeded one hundred (Gloger 1881). Loss of such

dams which redirected the flow and possibly maintained the anabranches for a tens of years, caused their slow extinction.

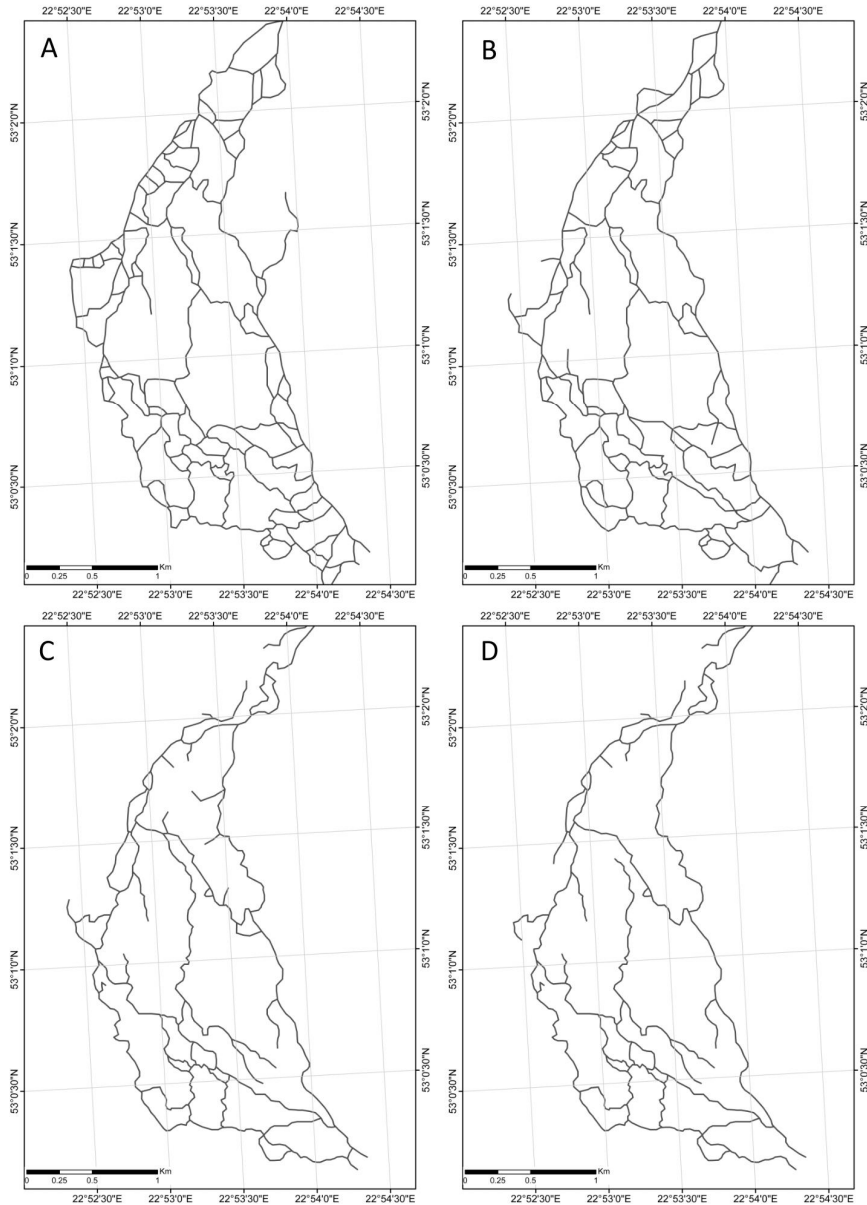

Figure 2. River planform changes detected through time; A- 1900, B- 1966, C- 1997, D- 2010.

Conservation strategies

Gradual extinction of the anastomosing system was a motivation for conservation strategies plan. Assessment of each of the strategy relies on the newfound knowledge of the system and its response on changes deduced by the comparison of the driving force with aerial imagery and maps reflecting the response of the system.

New water management on Siemianówka Reservoir is the conservation plan aiming at naturalisation of flow. As indicated through the flow records analysis, flow regime and inundation occurrence, magnitude and duration have changed significantly after constructing the dam. It is clearly proved that one of the major factors maintaining the

side channels is constant flow in every channel preventing its closing and overgrowth by plants. Current water release management at the dam caused a meaningful reduction of high flows and inundations leading to exact opposite situation and many side channels for a long period of time are not contributed by flow which causes their slow extinction. The naturalisation of flow restoring the high water levels and natural floods during spring time would improve the condition of the flooded ecosystems and control the growth of vegetation across the anabranches, significantly restricting their invasion into the channels and preventing excessive blockages. This in turn would reduce the number of extinct anabranches and stop the gradual deterioration of this anastomosing fluvial system and could possibly reverse the tendency by creating new channels through the avulsion process.

Creation of minor wooden dams on the channels to redirect a part of the flow into side channels would be very helpful for maintaining all side channels which are thread of drying out during low water stages. In the past a lot of wooden dams were constructed by local residents for farming, watermills purposes and fishing. It was stated by Banaszuk et al. (2004) that this activity contributed the development of the system. Reconstruction of such dams using natural materials (wood, stones) could possibly continue the maintenance and development of the system ensuring the constant flow redirected from main to side channels .

Dredging the inlet part of side channels is aimed at opening the inlet part of the channel for discharge to facilitate its inflow. The most common reason of channel extinction is gradual closing of the inlet part of the channel which from year to year accepts less flow until it is completely cut-off. Opening the inlet part by dredging restores the appropriate conditions of the system and ensures the constant flow in side channels.

Organised mowing schedule is aimed at maintenance of early growth stadium of vegetation in the valley and preventing from natural succession into shrubs and forests. On the other hand complex mowing of the valley is not beneficial for avulsion process triggered by blocking the channels and local, natural damming of water. Therefore a compromise could be the targeted cessation of riparian vegetation around anabranch confluences and divergences. This would allow natural succession to occur in these areas, which would lead to the establishment of riparian trees and eventually the delivery of large wood to the channel. Wood delivery and the formation of jams/dams would locally increase water levels and ensure that water is diverted into anabranches. This localised approach would minimise the impacts on the vegetation community in the remaining floodplain, leaving the reed/sedge dominated community, but also support it by increased water levels. In addition to the immediate benefits to water levels, log jams/dams also introduce hydraulic complexity, facilitate the formation of geomorphic units, and significantly slow the conveyance of flood waters thereby increasing inundation frequency and duration. Although the drivers of geomorphic change would switch from herbaceous riparian plants to woody trees and shrubs, the channel would still be expected to be stable because the erosion-resistant peat banks and low specific stream power limit the potential for bank erosion, channel migration and channel avulsion.

Preliminary results

The investigation of NNP reaches hydromorphology indicated that changes in anastomosing stretch of the river are very slow. The key controlling factors are in general related to water level and pattern of vegetation. Changes of any of them in the past resulted in slow but gradual extinction of anabranches. Therefore the most important attribute for the system is to maintain in the short term is local water level, ensuring constant flow in the anabranches. For longer-term maintenance of anabranches, fine sediment supply upstream of NNP must be controlled, as deposition in the anabranches can aggrade the bed and eventually cause its complete closing. Naturalisation of flow from the dam is also very significant, particularly the frequency, magnitude and timing of peak flows shape the valley. Naturally the system is very stable and controls the processes by itself through the seasonal diversity of flow. However, constructing the dam upstream of the NNP has changed the natural regime of the river which from that time has become more human-controlled than natural. Hence, passive protection of the NNP might not be efficient and leaving the nature to solve the problem by itself could be a wrong solution. Given the proposed conservation strategies and their potential effects the restoration and further maintenance of the anastomosing system, combination of approaches could be much better solution in the face of undertaken changes. Incorporation of active solutions but using environmental friendly materials such as stones and wood could be more efficient.

Acknowledgements

The work leading to this paper has received funding for the EU's FP7 under Grant Agreement No. 282656 (REFORM).

References

- Banaszuk, H. et al., 2004. Przyroda Podlasia : Narwiański Park Narodowy.[Nature of Podlasie: Narew National Park] Białystok : Narwiański Park Narodowy.
- Gloger Z., 1881. Wędrowiec.[Wanderer]. No 259, 379-381. Warszawa.
- Gradziński, R., Baryła, J., Doktor, M., Gmur, D., Gradziński, M., Kędzior, A., Paszkowski, M., Soja, R., Zieliński, T., Żurek, S., 2003. Vegetation-controlled modern anastomosing system of the upper Narew River (NE Poland) and its sediments. *Sedimentary Geology* 157(3): 253-276. DOI: 10.1016/S0037-0738(02)00236-1.
- Gurnell, A.M., Bussetini, M., Camenen, B., González Del Tánago, M., Grabowski, R.C., Hendriks, D., Henshaw, A., Latapie, A., Rinaldi, M., Surian, N., 2014. A multi-scale framework and indicators of hydromorphological processes and forms. Deliverable 2.1, Part 1, of REFORM (REstoring rivers FOR effective catchment Management), a Collaborative project (large-scale integrating project) funded by the European Commission within the 7th Framework Programme under Grant Agreement 282656.
- Makaske, B., 2001. Anastomosing rivers: a review of their classification, origin and sedimentary products. *Earth-Science Reviews* 53, 149 – 196.
- Mioduszewski, W., Napiórkowski, J., Okruszko, T., et al., 2014. Plan Ochrony Narwiańskiego Parku Narodowego. [Narew National Park Protection Plan]. Białystok, Narwiański Park Narodowy.

Ecological evaluation & hydraulic modelling of the 'process restoration' philosophy on the Allt Lorgy, Scotland

Moir H & Gillies E

HAMISH MOIR^{1,2} & ERIC GILLIES¹

¹ *cbec eco-engineering UK Ltd, 3 Aberdeen Road, Alford, Scotland, AB33 8ED*

² *Rivers and Lochs Institute, University of the Highlands and Islands, 3 Longman Road, Inverness, Scotland, IV1 1SA*

The importance of hydraulic modelling to assess the efficacy of river restoration design using large wood to promote natural process is illustrated using the Allt Lorgy river restoration project in the Cairngorm National Park in Scotland. This case study comprises a rare set of 2D and 3D hydraulic models, obtained pre-construction; post-construction; and post- 100 year+ flood. These models are used to estimate the hydraulic function of the river, and specifically the available spawning habitat - an improvement upon which was a key goal of the restoration project. The complexity and limitations of using a computational fluid dynamic approach are highlighted, with particular focus paid to the use of 2D depth-averaged hydraulics in predicting flow behaviour around large wood. The utility of using computational fluid dynamics for assessing spawning habitat is shown, and the Allt Lorgy case study itself provides an example of a design that leads to improved habitat.

Introduction

In river systems, hydrodynamic forces drive geomorphic change. Representative modelling of channel hydraulics is therefore an invaluable tool in river restoration design, enabling a quantitative and objective assessment of complex processes that are essential to achieve restoration objectives. Hydraulic modelling can form part of an iterative design process, utilised to help indicate 'design performance', both in terms of physical stability of the post-restoration channel and long-term ecological function. The hydraulic model can output a wide range of descriptors (e.g. heterogeneity of channel depth and velocity, bed shear stresses, inundation extent), providing quantitative information on various indices of performance at each stage of the design. The *Allt Lorgy* project in the Cairngorms National Park in Scotland is an example of a recent river restoration project where hydraulic modelling was used extensively. This river is a small upland gravel-bed river (bankfull capacity of about 10 cubic metres per second) that has been extensively managed (straightened and embanked) for agriculture.

During the restoration design process, hydraulic modelling was used to indicate floodplain reconnection from the lowering of embankments, improvements to hydraulic heterogeneity introduced by placement of large wood structures, and lateral hydraulic forcing (related to large wood placement and lateral bar development through gravel augmentation). While it is difficult to predict the exact geomorphic change that results from these restoration methods, the perturbed hydraulics push the river morphology out of its impacted equilibrium and begin a trajectory to more natural processes and heterogeneous physical conditions (channel morphology, sedimentology, hydraulics). The

hydraulic modelling can predict the degree to which embankment removal, placing of large wood and gravel augmentation move physical processes towards this objective. This perturbation (i.e. introduced by placement of large wood, embankment removal and gravel augmentation) can be shown by shear stress computations and also, in limited parts of the *Allt Lorgy*, by 3D vorticity computations. An example of computed floodplain reconnection forced by large wood dams is shown in Figure 1.



Figure 1. Improved floodplain reconnection predicted by model. Also shown is a relatively heterogeneous channel compared to a flume-like pre-restoration channel; a) image showing embankments found on pre-restoration reach; b) example of embankment removal and large wood placement; c) hydraulic inundation results showing floodplain connection. Flow is from bottom to top of figure.

However, it is important that the limitations of any computational fluid dynamic approach (e.g. 2D depth-averaged simulations) are well communicated to other specialists (e.g. geomorphologists, ecologists, managers, regulators and clients). One aspect of hydraulics where this is specifically important is in the use of 2D depth-averaged hydraulics in predicting erosion and scour, as these are often exacerbated by secondary flow effects and three dimensional vorticity (e.g. secondary flow in meander bends or at confluences). It has long been recognised that eddies from channels with re-introduced

sinuosity or from added wood structures are specific drivers of erosion and deposition of sediment. Specifically, the interpretation of vorticity patterns from 2D depth-averaged river models must be treated with caution, or provided with further interpretation. To illustrate, we present work that demonstrates hydraulic modelling of these wood features. A multi-stage modelling method is presented, where wood is treated as a change to bed friction for low to medium flows, and a change to bed topography at high flows. This procedure is necessary because most wood features allow flow underneath and over the structure. The wood structures themselves cause vertical accelerations in the flow that are not captured by 2D hydraulic models. As a result, the immediate post-restoration hydraulic modelling is, unlike the pre-design model, relatively inaccurate at low flows close to the large wood, although it is useful in demonstrating floodplain reconnection at high flows, and in showing perturbations to bed shear stress.

However, for the *Allt Lorgy* the river is now largely being left to allow a natural recovery of physical process and form. Observations post-restoration have indeed shown re-establishment of more natural river processes. In August 2014, the river was subject to a large flood event (possibly in excess of a 100-year recurrence interval), causing significant sediment transport and associated morphological adjustment of the channel. This has had the effect of both introducing greater heterogeneity in channel hydraulics (i.e. depth and velocity) and sediment characteristics, but also in 'smoothing out' the bed level perturbations caused by the large wood, i.e. as gravel rearranges in the proximity to the large wood features, the flow becomes more easily modelled in 2D. This effect is shown in Figure 2. This set of models is therefore somewhat rare, in that we are able to present pre-, post-restoration and post >100 year flood model.

Other studies have demonstrated that the Froude number is a good single, non-dimensional descriptor of instream habitats, notably that of salmonid spawning habitat (e.g. Moir et al., 2002). We present arguments, based on fundamental hydraulic theory, to show that there are sound physical reasons why Froude number and available particle substrate size should indeed predict the areas of a river suitable for spawning. Using the three hydraulic models we show a clear improvement in hydraulic heterogeneity over time, benefiting all fish life stages (shown in Figure 3). Specifically, we also show that the Froude number has a greater area in the range suitable for salmon spawning in the post-flood channel condition. Using Froude number model output and combined modelled/measured particle substrate size, we predict almost a doubling of suitable spawning habitat in the channel. The model predicted spawning habitats are shown to be collocated with observed redds in the *Allt Lorgy* in November 2014. Although only five redds were observed, all of these correlate with predicted high suitability spawning habitat.



Figure 2. One of the large wood features introduced to the *Allt Lorgy*. Left: Channel spanning log showing complex post design flow paths, and large 3D perturbation to flow; Right: same log feature post-natural gravel transport; the wood feature is now more easily modelled in 2D.

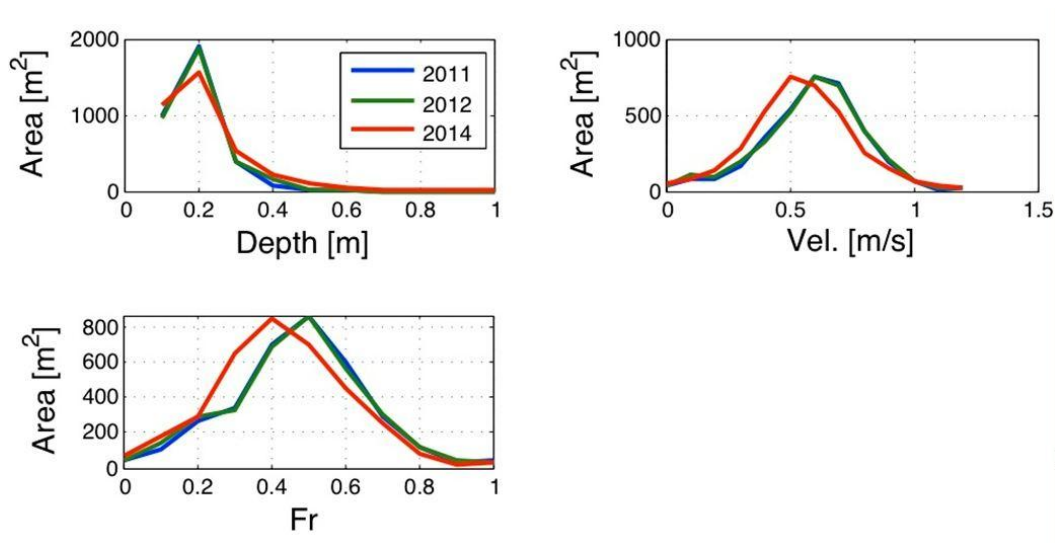

Figure 3: Improvement in hydraulic heterogeneity predicted by analysing three hydraulic models of the *Allt Lorgy*: Pre-restoration, immediate post-design and post-large >100 year flood. The Froude number specifically has more area in the range suitable for salmon spawning.

References

Moir, H.J., Soulsby, C., Youngson, A.F. (2002). Hydraulic and sedimentary controls on the availability and use of Atlantic salmon (*Salmo salar*) spawning habitat in the River Dee system, northeast Scotland. *Geomorphology* 45: 291–308.

Evaluation and prioritization of river rehabilitation projects

Reichert P, Paillex A & Schuwirth N

PETER REICHERT, AMAEL PAILLEX & NELE SCHUWIRTH
*Eawag: Swiss Federal Institute of Aquatic Science and Technology,
 8600 Dübendorf, Switzerland.*

We use multi-criteria decision analysis (MCDA) techniques to support the transparent communication of the expected achievement of societal objectives in river management with a focus on river rehabilitation. We apply the techniques to support the assessment of the trade-off between the expected gain in ecological value and ecosystem services versus costs for specific river rehabilitation projects.

Introduction

This presentation is based on our contributions to the deliverables 5.2 (Brouwer et al. 2015) and 5.4 (Reichert et al. 2015b) of the EU project REFORM. See these deliverables and Paillex et al. (submitted) and Reichert et al. (in preparation) for more details.

Multi-criteria decision analysis (MCDA) has originally been developed as an approach for the support of rational decision making by individual decision makers (Keeney and Raiffa 1976; Eisenführ et al. 2010). However, the advantages of such a structured approach for societal decision making and for transparently negotiating and communicating decisions has been realized in environmental decision support in general (see Reichert et al. 2015a and references cited therein).

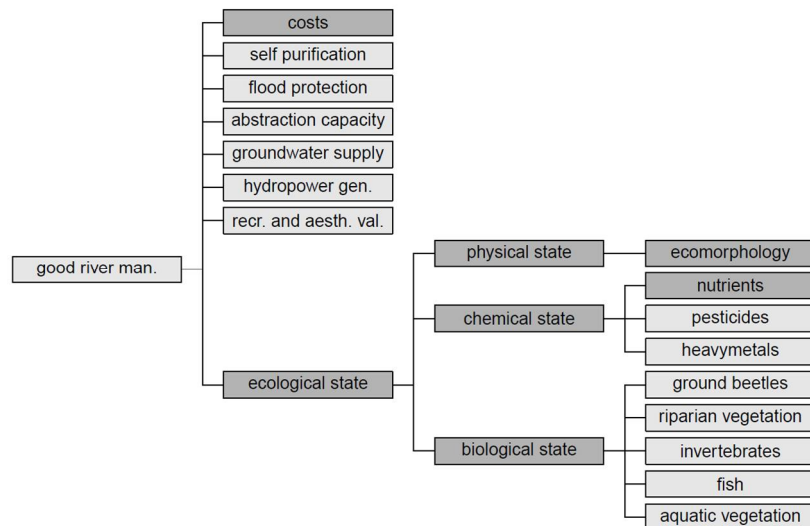

Figure 1. Objectives hierarchy of river management. Dark boxes indicate sub-objectives the evaluation of which is mandatory for evaluating the associated sub-objective at the next higher hierarchical level (from Brouwer et al. 2015).

Figure 1 shows the objectives hierarchy used for a societal evaluation of measures in river management that we will use to assess rehabilitation measures at a river reach. This

objectives hierarchy is used for an MCDA that corresponds to a Cost-Benefit Analysis (CBA) in environmental economics.

Study site

The study site consists of a channelized reach and a rehabilitated reach at each of the two rivers Thur and Töss. The river Thur at this site is of 7th stream order and has an average discharge of 53 m³/s. The river Töss at the study site is of 6th stream order with an average discharge of 10 m³/s. Figure 2 provides an overview of the four sub-sites; more details can be found in Paillex et al. (submitted).



Figure 2. Illustration of channelized sections (left) and rehabilitated sections (right) of the Thur (top) and Töss (bottom) Rivers (pictures P. Reichert, Sept. 24, 2013; figure from Brouwer et al. 2015).

Results

The Figs. 3 and 4 show the resulting values and their uncertainties at all plotted levels of the objectives hierarchy shown in Fig. 1 for the rivers rehabilitated and channelized sections of the rivers Thur and Töss, respectively.

Within the branch of the characterization of the ecological state, Figs. 3 and 4 show that rehabilitation increases the physical state to the highest quality class. Due to the short rehabilitated section, the chemical state was not expected to change and was measured in the degraded section only. The biological state increases significantly, but as it crosses only one class boundary, it increases only by one quality classes for each of the rivers. Despite the significant increase in many aspects, the ecological state does not quite reach a good state (green color) for the river Thur, but it does for the river Töss. See Paillex et al. (in preparation) for a more detailed discussion.

At the highest hierarchical level, the rehabilitated section has a significantly higher value than the degraded section in the case of the river Töss. For the river Thur, both overall evaluations lead to very similar values, but in the rehabilitated case reaching a good ecological state.

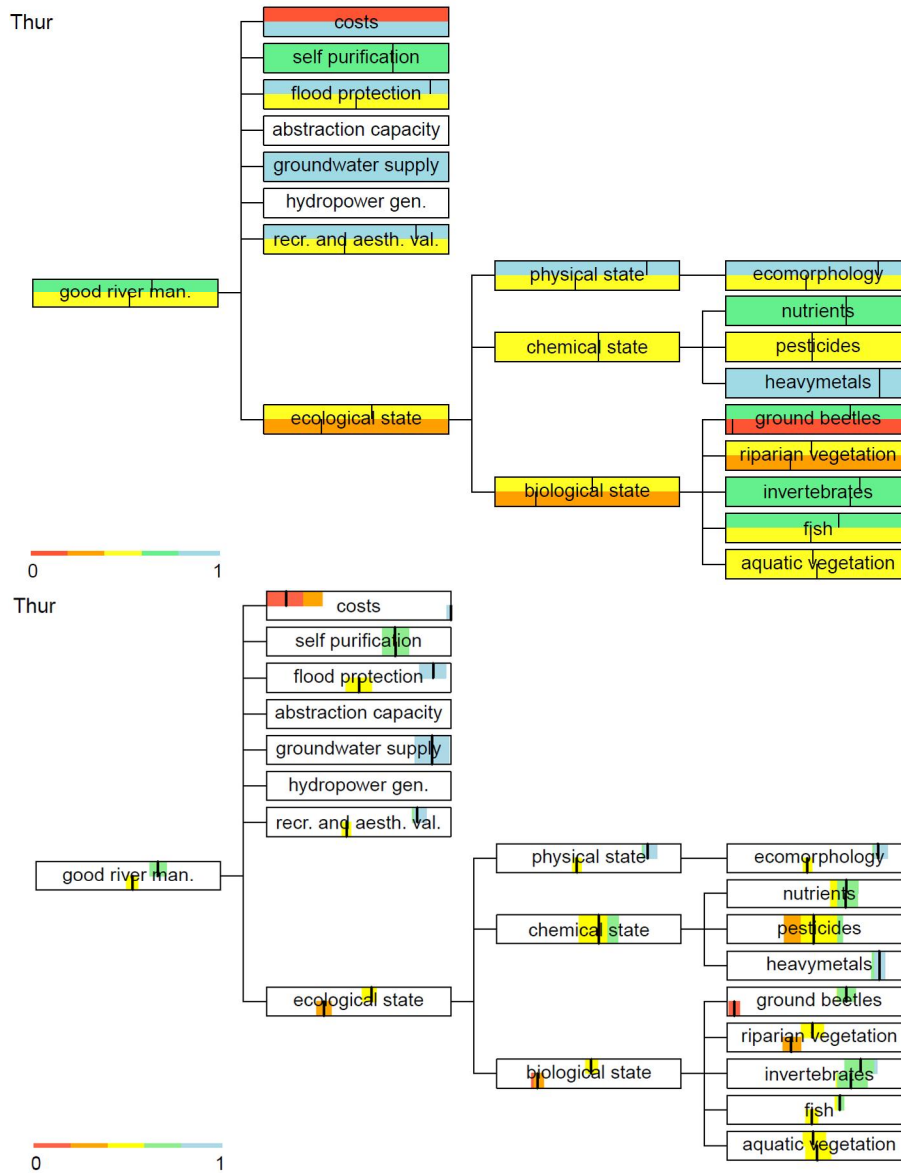

Figure 3. Comparison of the evaluation of rehabilitated (top) and channelized (bottom) sub-sites of the river Thur. Vertical lines indicate values on a horizontal scale from 0 to 1 in each box. Top panel: the sub-boxes are colored according to the five colors indicated in the legend. For the ecological sub-objectives, this corresponds to ecological quality classes. Bottom panel: colored ranges represent 90% uncertainty ranges. White boxes indicate that no data is available as these sub-objectives are not applicable at the investigated site. Figure from Brouwer et al. 2015 (top) and Reichert et al. 2015b (bottom).

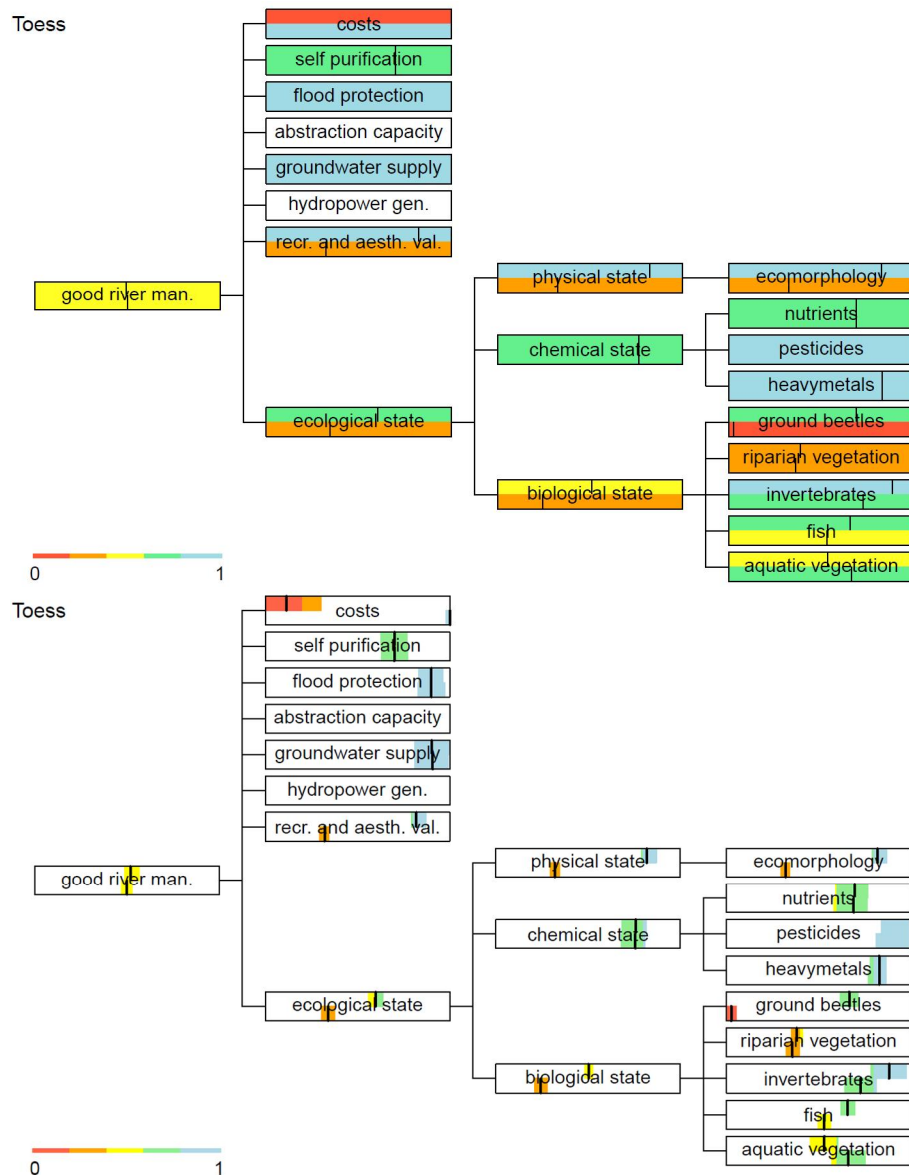

Figure 4. Comparison of the evaluation of the rehabilitated (top) and the channelized (bottom) sub-sites of the river Töss. See caption of Fig. 3 for explanations. Figure from Brouwer et al. 2015 (top) and Reichert et al. 2015b (bottom).

Conclusions

This analysis provided important insights into the costs and benefits of river rehabilitation projects and on how a transparent outline of these issues can support transparent societal decision making about the trade-off between costs and benefits.

- The rehabilitation project at the river Töss fulfilled the goal of reaching a good ecological state, whereas that in the river Thur just failed to reach this goal. This is mainly caused by a low chemical state and poor vegetation communities with the presence of invasive plants. These results are preliminary as some of the assessment modules are still at a preliminary stage, and the states of the rehabilitated sections are close to the boundary between the classes of a moderate and a good state.

- The comparison of the overall evaluation clearly demonstrates that combined flood protection and rehabilitation projects make it much easier to outweigh the costs by the benefits.
- The uncertainty analysis confirms that most of the observed differences are significant.

Our analysis still has some deficits. The two most important ones are the following:

- Willingness to pay estimates for ecological gain and ecosystem services are based on transfer from past studies and the democratic legislation process in Switzerland. This provides a reasonable rough estimate, but more precise estimates could be obtained from a study that would collect primary data. Such a study is currently under way (Logar et al., in preparation). Note that a similar procedure as used here could be used to optimize the gain in ecological state and ecosystem services given a fixed budget or to determine the most cost-effective alternative to reach a certain ecological state. This task would not be affected by the high uncertainties associated with the benefits estimates of ecosystem services.
- Analyzing cost-benefit trade-offs for individual rehabilitation projects bears the deficit that synergies of optimal combinations of such projects by systematic, spatial rehabilitation planning are neglected (Langhans et al. 2014; Reichert et al. 2015a). As rehabilitation of a whole river corridor at a larger spatial scale can lead to significant additional improvements in particular in the ecological state and for recreation compared to restoring the same total river length dispersed over the catchment, the benefit estimates can be assumed to be closer to a lower bound than to a median estimate. We will try to address these issues in Reichert et al. (in preparation).

References

- Brouwer, R. et al. (2015). Cost-effective restoration measures that promote wider ecosystem and societal benefits. *REFORM Deliverable 5.2*.
- Eisenführ, F., Weber, M. and Langer, T. (2010). *Rational Decision Making*. Springer, Berlin, Germany.
- Keeney, R.L. and Raiffa, H. (1976). *Decisions with Multiple Objectives: Preferences and Value Tradeoffs*. John Wiley & Sons, New York.
- Langhans, S.D., Hermoso, V., Linke, S., Bunn, S.E., Possingham, H.P. (2014) Cost-effective river rehabilitation planning: Optimizing for morphological benefits at large spatial scales. *Journal of Environmental Management* 132: 296-303.
- Logar, I., Brouwer, R. (in preparation). Economic assessment of river restoration in Switzerland.
- Paillex, A., Schuwirth, N., Lorenz, A., Januschke, K., Peter, A. and Reichert, P. (submitted), Quantifying and valuing river rehabilitation effects.
- Reichert, P., Langhans, S.D., Lienert, J. and Schuwirth, N. (2015a). The conceptual foundation of environmental decision support. *Journal of Environmental Management* 154, 316-332.
- Reichert, P. et al. (2015b). Risks and Uncertainty in River Rehabilitation. *REFORM Deliverable 5.4*.
- Reichert, P., Paillex, A., Logar, I. and Schuwirth, N. (in preparation). Evaluation and prioritization of river rehabilitation projects.

New tools for an integrated hydromorphological assessment of European streams

Rinaldi M et al.

RINALDI M.¹, BELLETTI B.¹, BUSSETTINI M.², COMITI F.³, GOLFIERI B.⁴, LASTORIA B.², NARDI L.¹, SURIAN N.⁴

¹*Department of Earth Sciences, University of Firenze, Via S.Marta 3, 50139 Firenze, Italy*

²*Institute for Environmental Protection and Research (ISPRA), Via Vitaliano Brancati 48, 00144 Roma, Italy*

³*Faculty of Science and Technology, Free University of Bozen-Bolzano, Piazza Università 5, 39100 Bolzano, Italy*

⁴*Department of Geosciences, University of Padova, Via Gradenigo 6, 35131 Padova, Italy*

In this paper, we propose a comprehensive and synergic hydromorphological assessment based on the integration of three tools, originally developed in Italy and then expanded to other European countries within the context of the REFORM project. The Morphological Quality Index (MQI) is a tool designed to assess the overall morphological condition of a stream reach and to classify its current morphological state. The Morphological Quality Index for monitoring (MQIm) is a specific tool for monitoring the tendency of morphological conditions (enhancement or deterioration) in the short term. The Geomorphic Units survey and classification System (GUS) is used to characterise the typical assemblage of geomorphic units within the reach. The three tools, used synergically, can provide an overall assessment of stream reaches which is useful for understanding their functioning, and therefore for supporting the identification of appropriate management actions.

Key words: Hydromorphological assessment, Morphological alteration, MQI, MQIm, GUS

Introduction

Since the Water Framework Directive (WFD) introduced hydromorphology as a component of the assessment and monitoring of water bodies, the need to develop new hydromorphological assessment methods has expanded rapidly. Most of the methods initially focussed upon the occurrence and spatial configuration of physical habitats. However, it has been increasingly recognised that a broader river condition assessment with a stronger emphasis on river dynamics and processes is required to go beyond an inventory of physical habitats (Belletti et al., 2015a). As a result, a series of methods and tools for an integrated and synergic assessment of hydromorphology was initially developed in Italy (Rinaldi et al., 2013), and then expanded to other European countries in the context of the EU project REFORM (REstoring rivers FOR effective catchment Management). This paper briefly illustrates the general characteristics, aims, mutual links, and possible applications of this set of assessment tools for supporting the identification of management actions.

The overall assessment framework

The methods presented in this paper are part of a broader multi-scale, process-based assessment framework developed in the Deliverable 6.2 of the REFORM project. The overall methodological framework provides a coherent set of methods and tools with which to practically assess and monitor hydromorphological conditions. The framework is organised with a clear structure involving a sequence of procedural stages and steps to conducting an assessment of river conditions and lastly to supporting the selection of appropriate management actions in a meaningful, coherent, and consistent manner. The framework comprises four stages: (1) catchment-wide delineation and spatial characterization of the fluvial system; (2) assessment of temporal changes and current conditions; (3) assessment of scenario-based future trends; (4) identification of possible hydromorphological restoration or management actions.

The three methods illustrated in this paper are mainly a part of the assessment and monitoring phase (stage 2), but can also be used to support stages 3 and 4. The main aims and typical applications of each one of the three tools are summarised in Table 1.

Table 1. Main aims and typical applications of MQI, MQIm, and GUS.

Tool	Aims	Applications
MQI	Assessment, classification and monitoring of the current morphological state	Evaluate morphological alterations compared to reference conditions (spatial scale: reach)
MQIm	Monitoring tendency of morphological conditions (enhancement or deterioration)	Evaluate changes of morphological quality in the short term (spatial scale: reach)
GUS	Characterization, classification and monitoring of geomorphic units	Characterise geomorphic units and establish links with hydromorphological and biological conditions (spatial scale: geomorphic unit)

The Morphological Quality Index

Compared to physical habitat assessment methods, the development of the Morphological Quality Index (MQI) was based on a more robust geomorphological approach. The method is based on the consideration of processes rather than only of channel forms. Aspects such as continuity in sediment and wood flux, bank erosion, lateral mobility, and channel adjustments are taken into account. The temporal component is explicitly accounted for by considering that an historical analysis of channel adjustments provides insight into the causes and time of alterations and into future geomorphic changes.

The method has been developed and applied in Italy (Rinaldi et al., 2013), and then improved and expanded to other European countries after appropriate verification and modifications within the context of the Deliverable 6.2 of the REFORM project.

The MQI is applied at the reach-scale (i.e., a relatively homogeneous portion of the river with a length of the order of some km) by an integration of remote sensing – GIS analysis and field survey. The assessment includes a set of twenty-eight indicators assessing longitudinal and lateral continuity, channel pattern, cross section configuration, bed structure and substrate, and vegetation in the riparian corridor. These characteristics

are evaluated in terms of three components: geomorphological functionality, artificiality, and channel adjustments. The overall assessment procedure is carried out by using two different evaluation forms: one for confined channels, and one for partly confined and unconfined channels.

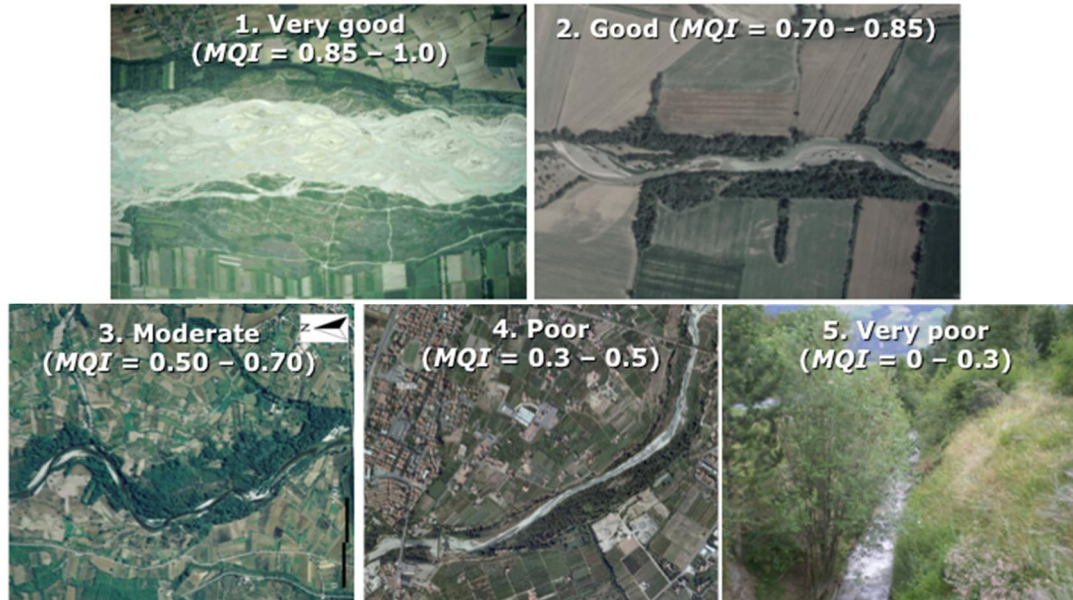

Figure 1 Examples of the five MQI classes.

Three classes are generally defined for each indicator: (A) undisturbed conditions or negligible alterations (reference conditions); (B) intermediate alterations; (C) very altered conditions. The evaluation is based on a scoring system, considering that reference conditions are identified with a river reach in dynamic equilibrium, performing the morphological functions that are expected for a specific morphological typology, and where artificial elements and pressures are absent or do not significantly affect the river dynamics. Scores have been defined by the Authors of the original method (Rinaldi et al., 2013) and remained unchanged in this extended version, in order to ensure data comparability when applied to different European countries. A total score is computed as the sum of scores across all components and aspects, and the final result is the Morphological Quality Index (MQI), ranging from 0 (minimum quality) to 1 (maximum quality). Based on the MQI value, five classes are defined to classify morphological quality conditions (from very poor to very good) and to comply with the WFD requirements (Figure 1).

The MQI has been widely applied in Italy and has been tested for various rivers in Europe in the context of REFORM to represent different condition in terms of physical characteristics and human alterations (Nardi et al., 2015).

The Morphological Quality Index for monitoring

The MQI was mainly designed to assess the overall current morphological condition of a stream reach, reflecting alterations over a relatively long time scale (i.e., last 50 years or longer periods). Therefore, the MQI may not be suitable for monitoring short-term changes of channel conditions, in particular if such changes refer to a short period of time or if changes occur in small portions of the reach. To address this limitation, a different tool, named Morphological Quality Index for monitoring (MQIm), was specifically designed to take into account small changes (e.g. relative to small portions of a reach)

and short time scales (i.e., a few years). Therefore, MQIm is particularly suitable for the environmental impact assessment of interventions, including either flood mitigation and restoration actions.

Some of the main differences and integrations between MQI and MQIm are the following: (1) the MQI is the tool for the evaluation, classification, and monitoring of the morphological state (i.e., good, poor, etc.), whereas the MQIm is a specific tool to evaluate the tendency of morphological conditions (enhancement or deterioration); (2) the MQI scores are based on discrete classes, whereas the scores of several MQIm indicators are based on continuous mathematical functions; as a consequence, MQIm is more sensitive to changes occurring at a temporal scale of just a few years.

The MQI and MQIm evaluate morphological quality on a different temporal scale, therefore they can be considered as complementary rather than alternative assessments. The MQIm provides an indication on the trend of morphological quality in the short term. For this scope, the value of MQIm related to a single situation is not meaningful, while it is necessary to calculate the difference of the index between two assessments, since this will indicate a tendency to an enhancement or deterioration of the morphological quality.

The Geomorphic Units survey and classification System

The spatial scales of geomorphic unit and smaller (hydraulic units and river elements) are the most appropriate for assessing physical habitats. Geomorphic units (e.g., riffles, pools, etc.) constitute distinct habitats for aquatic fauna and flora, and may provide temporary habitat requirements (refugia from disturbance or predation, spawning, etc.). Procedures to assess physical habitat need to be ecologically and geomorphologically meaningful, so that ecologically relevant scales and physical variables must be placed into a geomorphological characterization template. Because geomorphic units constitute the physical basis for habitat units, a characterization of the assemblage of geomorphic units will provide information about the existing range of habitats occurring in a given reach.

Geomorphic units are linked to the reach scale, given that processes of water flow and sediment transport that control the geomorphic units are influenced by factors acting at reach scale (e.g., slope, substrate, and valley setting). Reaches of the same morphological type usually exhibit similar assemblages of geomorphic units. As a consequence, physical habitat characteristics and associated biotic conditions are strongly influenced by physical factors acting at reach scale, which in turn are constrained by regional- and catchment-scale features (e.g. landscape units, ecoregion) (Brierley et al., 2013).

In response to such needs, a new specific system for the survey and classification of geomorphic units (GUS) in streams and rivers has been developed in the context of REFORM. The system is suitable for integrating the MQI and is also aimed at allowing the establishment of links between hydromorphological conditions at reach scale, characteristic geomorphic units, and related biological conditions. More details on this system are reported in Belletti et al. (2015).

Applications and final remarks

The application of a method for the assessment of hydromorphological quality is extremely useful for analysing critical problems and causes of alteration, and eventually for identifying unaltered processes and forms that need to be preserved. As an example, the MQI can be particularly suitable for this type of application because of its structure with a clear definition of the various components of the evaluation (functionality, artificiality, channel adjustments, or longitudinal continuity, lateral continuity, morphology, substrate, vegetation). The evaluation structure provides a rational framework that is useful for identifying and prioritizing management strategies and restoration actions (Rinaldi et al., 2013). For example, a first obvious prioritization rule consists of preserving current conditions for those indicators which are in class A and considering some possible actions for improving those indicators lying in classes B and C.

The use of polar diagrams can help in visualising more clearly the results of the assessment in terms of critical problems. The example in Figure 2 refers to a reach with strong alteration of functionality, but relatively few artificial elements (Panaro River, Northern Italy). The main problems are related to a past reduction of sediment availability (because of gravel mining), present alteration by interception of bedload, and consequent severe channel incision. Therefore possible actions should be mainly oriented to promoting a recovery of sediment supply and longitudinal continuity.

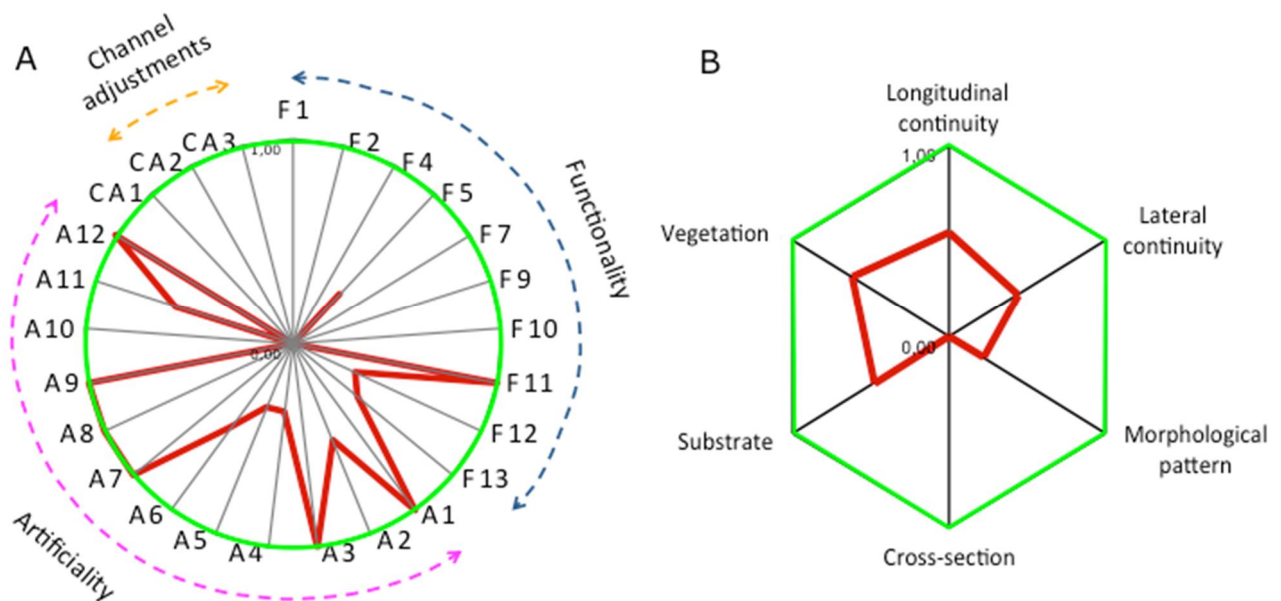

Figure 2. Application of polar diagrams to visualise the results of the MQI assessment. Green line: unaltered (reference) conditions; red line: actual conditions.

A synergic use of MQI, MQIm and GUS can provide an overall assessment of stream reaches useful for understanding their functioning, and therefore for supporting the identification of appropriate management actions. Table 2 summarises typical applications and interpretation of the results of the three methods.

Table 2. Application and interpretation of MQI , MQIm and GUS.

Tool	Application	Interpretation
MQI	Classification of current morphological conditions	A high (low) MQI indicates good (poor) current morphological status
MQIm	Monitoring morphological conditions Evaluation of impact of new interventions	An increase (decrease) of MQIm indicates enhancement (deterioration) of morphological conditions in the last few years or pre- and post-intervention
GUS	Characterization and monitoring of geomorphic units	An increase of diversity of geomorphic units is not necessarily indicative of enhancing morphological conditions but must be interpreted in combination with <i>MQI</i> and <i>MQIm</i>

It is important that the outputs of the GUS are interpreted in combination with the results of the MQI and MQIm. For example, an increase in the abundance and diversity of geomorphic units in a given reach is not necessarily related to an improvement of morphological conditions but may be associated to the presence of artificial conditions (e.g., presence of weirs). On the contrary, a low diversity of geomorphic units can be the result of a 'natural' simple geomorphic structure of a particular stream type. Therefore, the survey of geomorphic units at the site-scale must be necessarily combined with a MQI assessment at reach-scale to better interpret the significance of a diversity of geomorphic units and its relevance. Some examples are provided as follows.

- (1) Reach-scale morphological assessment (MQI) results in very good status. This means that geomorphic processes are unaltered or slightly altered, and the geomorphic units at site-scale represent the typical assemblage that could be expected for this river typology in the current conditions.
- (2) Reach-scale morphological assessment results in a very poor status. This implies that geomorphic processes are intensely altered, and the geomorphic units at site-scale do not represent the typical assemblage that could be expected for such a river in undisturbed conditions.
- (3) A repeated application of GUS reveals an increase in abundance and/or diversity of geomorphic units. In the case that the MQIm shows a tendency to an enhancement, the increase of geomorphic units is a result of enhanced morphological quality. On the contrary, an increase of geomorphic units associated to a decrease of MQIm may be the result of additional elements of artificiality within the reach.

Acknowledgements

The work leading to this paper has received funding for the EU's FP7 under Grant Agreement No. 282656 (REFORM), whereas the original Italian version of the methods was funded by ISPRA (Istituto Superiore per la Protezione e la Ricerca Ambientale, Roma).

References

Belletti, B., Rinaldi, M., Gurnell, A.M., Buijse, A.D. and Mosselman, E. (2015a). A review of assessment methods for river hydromorphology. *Environmental Earth Sciences*, doi: 10.1007/s12665-014-3558-1.

- Belletti, B., Rinaldi, M., Comiti, F., Mao, L., Bussettini, M. (2015b). Development of a classification system of geomorphic units aimed at characterizing physical habitats and stream morphology. Proceedings REFORM Conference 2015 (this volume).
- Brierley, G.J., Fryirs, K., Cullum, C., Tadaki, M., Huang, H.Q., Blue, B., 2013. Reading the landscape: integrating the theory and practice of geomorphology to develop place-based understandings of river systems. *Progress in Physical Geography*, 37(5), 601-621.
- Nardi, L., Rinaldi, M., Belletti, B., Comiti, F., Golfieri, B., Marchese, E., Surian, N., Brabec, K., Gielczewski, M., Hellsten, S., Kaufman, S., Marcinkowski, P., Muhar, S., Okruszko, T., Paillex, A., Poppe, M., Rääpysjärvi, J., Schirmer, M., Stelmaszczyk, M. (2015). Application of the Morphological Quality Index (MQI) to European case studies. Proceedings REFORM Conference 2015 (this volume).
- Rinaldi, M., Surian, N., Comiti, F. and Bussettini, M. (2013). A method for the assessment and analysis of the hydromorphological condition of Italian streams: The Morphological Quality Index (MQI). *Geomorphology*, 180-181, 96-108.

Fish fauna as indicator for large river-floodplain alterations. Case study: Danube Delta

Staras M

MIRCEA STARAS

Danube Delta National Institute, 165 Babadag Street, 820112 Tulcea, Romania

Abstract

In the Danube Delta, out of a total 540,200 ha, 30% has been lost due to embankments by 1990 but still preserve near-natural reference habitats. The human interventions are consequences of different land-use policies and priorities starting from the end of the 19th century: navigation improvements, capture fishery, reed harvesting, agriculture. Fishes are the only group of aquatic organisms for which historical information is available. Long term reliable data on commercial fishing and the history of hydrotechnical works could provide valuable information on the responses of the fish fauna at the catchment scale of the Danube Delta. At a reach scale, a relevant example of the impact of interruption of lateral connectivity on fish population is given by the case of blocking the canal between the Danube River and a group of lakes in May 2002. A sharp decrease of eurytopic fish species abundance was recorded after blocking the canal in all lakes, except remote lakes. A set of indicators to assess the status of river-floodplain connectivity is proposed.

Introduction

River floodplain reclamation has affected the processes and functions of the river-floodplain systems worldwide, including Europe's large rivers. This has large consequences for the migration of permanent aquatic organisms such as fish, affecting overall the biodiversity within the systems. According to the first River Basin Management Plans from the EU Member States, about 56% of the river water bodies have been reported as having less than good ecological status or potential and hydromorphological changes have been identified as the most widespread pressure on the ecological status. Classification of fish species into ecological guilds based on their habitat requirements in different life stages (Schiemer & Waidbacher 1992; Guti 1995) has become a common used tool and indicators for assessment of ecological integrity, connectivity status and restoration success in large river systems such as the Danube, the Rhine and the Oder river systems (Schiemer et al. 1991; Schiemer 20001; Schmutz & Jungwirth 1999; Grift 2001; Noble et al. 2007; Schomaker & Wolter 2011). The aim of the case study is to describe the impact of reduced hydrological connectivity between river and floodplain on fish in the large rivers reaches such as Danube Delta, supporting activities within the task 3.4 of the REFORM project.

Material and Methods

Catchment scale: Danube Delta

The Danube River is the second largest European river and the world's most international river basin with a length of 2,857 km and a catchment size of 801,463 km². At its end, the Danube Delta is located on the coast of the Black Sea and includes the area between its three arms located in Romania and the secondary delta of the Chilia arm, which is Ukrainian territory (Figure 1).

Table 1. General characteristics of the Danube Delta (Romania)

Characteristics		
Geographical coordinates	Latitude interval (N)	45.490000; 45.834000;
	Longitude interval (E)	28.741000; 29.790000;
Ecoregion		Pontic province
Catchment area (km ²)		4,560
Surface, total (km ²) ; in Romania (km ²)		4,180
		3,510
Climate		temperate
Geology		Siliceous, organic
Slope (m km ⁻¹) (max-min range)	Sulina arm	0.045-0.001
	Chilia arm	0.035-0.001
	Sf. Gheorghe arm	0.029-0.001
Discharge (m ³ s ⁻¹)	Minimum; average; maximum	1,350; 6,515; 15,540;
	Altitude (m, above sea)	Minimum; average; maximum
Inhabitants (number)		3.00; +0.52; +12.40; 15,000

About 30% of the natural wetlands have been lost in the Danube Delta due to embankments by 1990, but near-natural reference habitats have been preserved.

Data from scientific papers, grey literature, reports on historical hydromorphological changes in the Danube Delta and available long-term statistical data on capture fishery were used to identify and characterise the responses of fish at catchment scale. Uncertainty of fish data is lower for the data derived from the fully state-controlled system in Romania before 1990.

Reach scale: the Isac-Uzlina lake complex.

An example of the impact of interruption of lateral connectivity on the fish population is given based on the blocking the canal between the Danube River and a group of lakes in 2002 as a water management solution to mitigate the intensive siltation (Navodaru et al. 2005). These lakes are shallow and characterised by a gradient in connectivity and cumulative residence time described in Oosterberg et al. (2000) for the Danube Delta.

The multimesh-size gillnets were used for sampling before and after connectivity interruption, as described by Navodaru et al. (2002). Species composition was recorded by lakes as catch per unit of effort (100 m gillnet) in terms of abundance and biomass, and grouped by their preference for flowing or stagnant conditions.

Results

Fishery statistics indicate that catches before 1960s were dominated by common carp (*Cyprinus carpio*) (21%), pike (*Esox lucius*) (20%) and roach (*Rutilus rutilus*) (16%).

Embankment impacts

The embankment of 85% of the Lower Danube floodplain, upstream from the delta, was undertaken mainly between 1960-1965. A dramatic decline was seen in the fishery of common carp-based fishery in the Delta reflecting that this semi-migratory fish species lost key spawning and nursing areas. The habitat reduction resulted in fishery decline in general in the Lower Danube (Figure 1).

Dam impacts

The Iron Gates I and II hydropower dams that were built in 1970 (at km 943) and 1984 (at km 863) interrupted the spawning migration of sturgeons upstream, which contributed to the collapse of the sturgeon fishery in the whole Lower Danube-Black Sea system (Bacalbasa 1989).

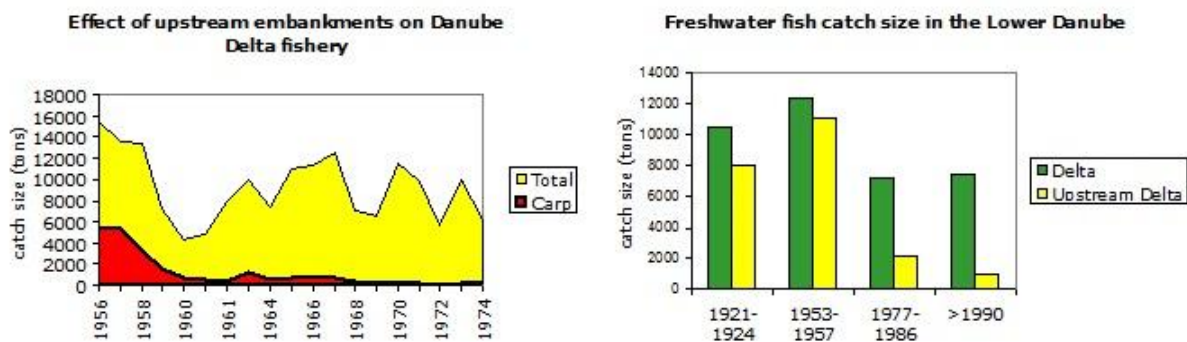

Figure 1. Effects of embankments on fishery in the Delta and Lower Danube.

In the case of the Isac-Uzlina lake complex the highest abundances in 2001 were recorded in lakes close to the river where eurytopic fish species dominated. A sharp decline in fish abundance was recorded in June 2002, after blocking the canal in all lakes, except for the most remote lake (Figure 2).

The rheophilic species asp (*Aspius aspius*), disappeared in those lakes with direct connection with river after blocking the connectivity. The findings confirm that fish fauna is a relevant indicator of the connectivity status of European large river systems (Table).

Fish abundance and residence time by lakes, June 2001-June 2002

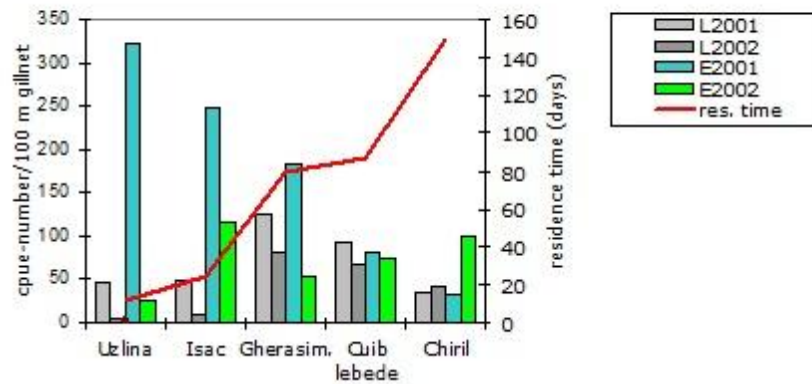

Figure 2. Fish abundance before and after blocking canal relative to lakes and fish guilds. (L=limnophilic; E=euritopic; res.time=residence time June 2001)

Table2. Indicators of fish responses to the connectivity status

Indicators	Connectivity status			
	Directly connected	Intermediate	Remote	Isolated
Residence time ¹	small	intermediate	large	very large
Fish abundance and biomass	high	medium	low	low
Rheophilic fish species abundance	low (VR)	low (VR)	low (VR) or absent	absent or very low (VR)
Euritopic fish species abundance	high (C)	intermediate	low (C)	low (C)
Limnophilic fish species abundance	low (RC)	low (RC)	high(C)	high (C)
L/Eu ratio	low	low	high	high
Fish community type	Eu	intermediate	L-Eu	L-Eu
Species richness	high	intermediate	low	Low, but highest limnophilic ²
Fishery status	good	good	fair to bad	collapsed

¹cumulated: travel time + lake residence time (Oosterberg et al. 2000)

²(Schiemer 1999; Schomaker and Wolter 2011)

Abundance status: C=common (>10%); RC=relatively common (5-10%);

R=rare (1-5%); VR=very rare (<1%);

Preference for current guild: L=limnophilic; Eu=euritopic; Rh= rheophilic

Conclusions

The Danube Delta proved to be an appropriate site for assessment of the impact of hydromorphological degradation on fish within a river-floodplain system. An explanation is that the Danube Delta with its lakes has remained a hydrological interconnected system. In many other European river floodplains as well as along the Danube River upstream of the Delta, floodplains have been isolated from the river, rendering distinction between factors influencing the fish more difficult.

Fishes are the only group of aquatic organisms for which historical information is available. Long-term data on commercial fishing and the history of hydrotechnical works gave valuable information on the impact at catchment scale. The development of the capture fishery in the Danube Delta correlates very well with habitat alterations showing a decline in some species and increases in others, changes in fish fauna composition and biodiversity loss. Reliable long-term commercial fishery data on migratory anadromous and potamodromous fish species may be useful to correlate and explain effects of historical changes in the lateral or longitudinal connectivity of the river systems.

Despite hydromorphological changes, our recent study showed that the Danube Delta is in a rather pristine state and that there is high diversity in fish community structure throughout the delta. The high fish species diversity in the lakes is due to the co-occurrence of rheophilic, eurytopic and limnophilic forms. From a management point of view, maintaining the existing connectivity gradient in the delta lakes is vital for biodiversity conservation and also social economic needs. The research results show that blocking of canals as a measure to mitigate siltation and nutrient inputs is not appropriate. Rather lengthening of the distance between the river and lakes by meandering and reducing the slope should be taken into consideration.

The results from the case study confirm that fish are excellent indicators of the lateral connectivity between large European rivers and their floodplains. A eurytopic-limnophilic community with presence of some rheophilic species indicates a connectivity gradient, whereas a limnophilic-eurytopic community type indicates low connectivity. Long-term isolation and stagnant water bodies are indicated by the presence of only limnophilic specialist species adapted to hypoxic conditions. Absence of rheophilic and decline of eurytopic-limnophilic species could be an indicator of recent or short-term connectivity interruption.

The acquired knowledge of the relationship between lateral and longitudinal river connectivity and fish species in their life stages is a sound basis for planning restoration measures in the large river-floodplain systems.

References

- Bacalbasa-Dobrovici, N. (1989). The Danube River and its Fisheries. In: Proceedings of the International Large River Symposium (Ed. D.P. Dodge), Can. Spec. Publ. Fish. Aquat. Sci. 106: 455-468.
- Grift, R. E. (2001). How fish benefit from Floodplain Restoration along the Lower River Rhine. PhD Thesis. Wageningen University, Wageningen. ISBN 9058084884.
- Guti, G. (1995). Conservation status of fishes in Hungary. Opusc. Zool. Budapest XXVII-XXVIII: 153-158.
- Navodaru, I., Buijse, A. D. and Staras, M. (2002). Effects of Hydrology and Water Quality on the Fish Community in Danube Delta Lakes. *International Review Hydrobiology* 87: 329-348.
- Navodaru, I., Staras, M., Buijse, A. D., de Leew, J. J. (2005). Changes in fish populations in Danube Delta lakes: effects of hydrology and water quality change. Review of results and potential for rehabilitation. *Ecohydrology & Hydrobiology* 5 (3): 245-256.
- Noble, R., Cowx, I., Goffaux, D. and Kestemont, P. (2007). Assessing the health of European rivers using functional ecological guilds of fish communities: standardising species classification and approaches to metric selection. *Fisheries Management and Ecology* 14: 381-392.
- Schiemer, F. (2000). Fish as indicators for the assessment of the ecological integrity of large rivers. In: *Assessing the Ecological Integrity of Running Waters* (Eds. Jungwirth, M. Muhar, S. and Schmutz, S.). *Hydrobiologia*, 422/423: 271-278.

- Oosterberg, W., Staras, M., Bogdan, L., Buijse, A.D., Constantinescu, A., Coops, H., Hanganu, J., Ibelings, B.W., Menting, G. A. M., Navodaru, I., Torok, L. (2000). Ecological gradient in the Danube Delta; present state and man-induced changes. RIZA rapport nr. 2000.15. Netherlands. ISBN 90.369.5309x.
- Schiemer, F., Spindler, T., Wintersberger, H., Schneider, A. and Chovanec, A. (1991). Fish fry associations: Important indicators for ecological status of large rivers. Verh. Internat.Verein. Limnol. 24: 2497-2500.
- Schiemer, F. and Waidbacher, H. (1992). Strategies for conservation of the Danubian Fish Fauna. In: River Conservation and Management (Eds.. Boon, P.J., Calow, P. and Pets, G.E.). Willey. Chichester: 364-382.
- Schmutz, S. and Jungwirth, M. (1999). Fish as indicators of large river connectivity: the Danube and its tributaries. Arch. Hydrobiol. 115 (Suppl.) (Large Rivers, 11): 329-348.
- Schomaker, C., Wolter, C. (2011). The contribution of long-term isolated water bodies to floodplain fish diversity. Freshwater Biology 56:1469-1480

Ecstatus: a methodology to assess the river and its surrounding area to inform project design and appraisal

Wharton G et al.

GERALDENE WHARTON¹, ANGELA M. GURNELL¹, ROSS MARSHALL², MARK ROSS³,
REBECCA SKINNER³ & DAVID GURNELL⁴

¹*School of Geography, Queen Mary University of London, London E1 4NS, UK*

²*Head of NEAS, National Environmental Assessment Service*

³*Operations Manager, National Environmental Assessment Service*

⁴*Director, Untyped Ltd.*

This paper reports on recent research with the National Environmental Assessment Service (NEAS), UK, which has developed a broad, high-level field survey assessment of both the river and its surrounding environment in terms of habitat and biodiversity, landscape, amenity and heritage. This ECOSTATUS survey has two main components: a River Survey (based on the Urban River Survey and compatible with the River Habitat Survey); and a Study Area Survey. Importantly, the new field assessments also capture the geomorphic dynamics of the river. It is envisaged that an ECOSTATUS survey will be conducted: immediately pre-project to assist in the design of a scheme; immediately post-project; and post-recovery from the works to evaluate the benefits of the project and inform adaptive management should this be necessary. A web-based geographical information system stores and manages the data.

Introduction

Assessments of the biophysical character and status of rivers are required to guide effective river management and restoration. When undertaken at the pre-project stage, as part of a baseline survey, assessments can usefully inform project design and provide a valuable marker against which future changes can be evaluated. Immediate post-project surveys check the implementation of the scheme against the project design (as-built survey) and subsequent surveys can monitor post-project recovery and quantify the longer-term benefits that may arise as well highlighting the need for adaptive management if issues emerge. Assessments are also required to provide evidence of legislative compliance such as meeting the target of Good Ecological Status (GES) or Potential (GEP) specified by the Water Framework Directive (WFD) (EC, 2000). However, whilst a large number of river habitat assessment methods have been developed, few approaches are directly applicable to modified rivers in urban catchments. To address this gap in the UK the Urban River Survey (URS) was developed (Boitsidis & Gurnell, 2004; Boitsidis et al., 2006; Davenport et al., 2001, 2004; Shuker et al., 2012) and designed to be fully compatible with the pre-existing River Habitat Survey (RHS) (Raven et al., 1998, 2000). Furthermore, there is an absence of assessment methods considering the wider setting of the project, such as adjoining green space which may also undergo rehabilitation as an integral part of the river restoration scheme. This need for a survey approach that would provide a more holistic characterisation of the area beyond the river, in addition to the biophysical survey of the river itself, was a key motivation in the recent development of ECOSTATUS.

ECOSTATUS Survey

Background and key features

ECOSTATUS has been developed in close collaboration with the National Environmental Assessment Service (NEAS), part of the Environment Agency, England, to provide a broad, high-level, field-based survey method that can be employed to collect information in relation to river projects in response to a variety of drivers such as Environmental Impact Assessments, river restoration and WFD compliance (Figure 1). It has two main components: a River Survey (based on URS); and a Study Area Survey. It is expected that an ECOSTATUS survey will be conducted on three occasions: immediately pre-project; immediately post-project; and post-recovery from the works (e.g. 5-10 years post-project). It aims to give a broad overview and appreciation of the project site and the study area in which it sits, based on field-based assessments that combine with desk-based information to provide a firm basis for project development, design and pre- to post-project appraisal. The survey is supported by a web-based information system, which allows entry and retrieval of survey data, undertakes data analysis, and presents assessments in map-based and graphical formats. The data entry process provides the facility to upload supporting information such as maps, photographs and notes.

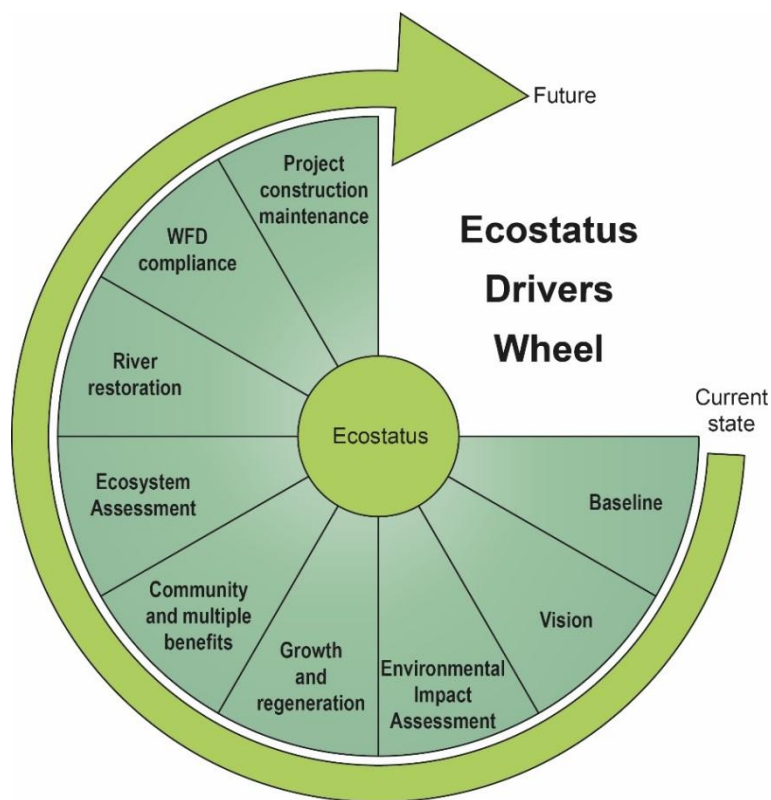

Figure 1. A conceptual diagram summarizing the drivers and timeline for the conduct of ECOSTATUS surveys.

The project site is defined as the area likely to be directly influenced by the project, that is the river and the area immediately bordering it. Whereas the study area includes the project site and the adjacent area that is indirectly affected by the project, and the fringe surrounds the study area and represents the visual envelope. For example, at Mayesbrook Park, East London (Figure 2), sections of the river flowing through the park

were restored in 2010 through re-meandering, bank re-profiling to re-connect the river with its floodplain, and the construction of a wetland to ameliorate poor water quality from a misconnected surface water inflow pipe. So the project site comprised the river channel and its corridor and the study area extended to the park beyond which was improved through landscaping, tree planting, and the addition of facilities such as a new children's play area and outdoor gym. Residential housing and road and rail infrastructure comprised the fringe.

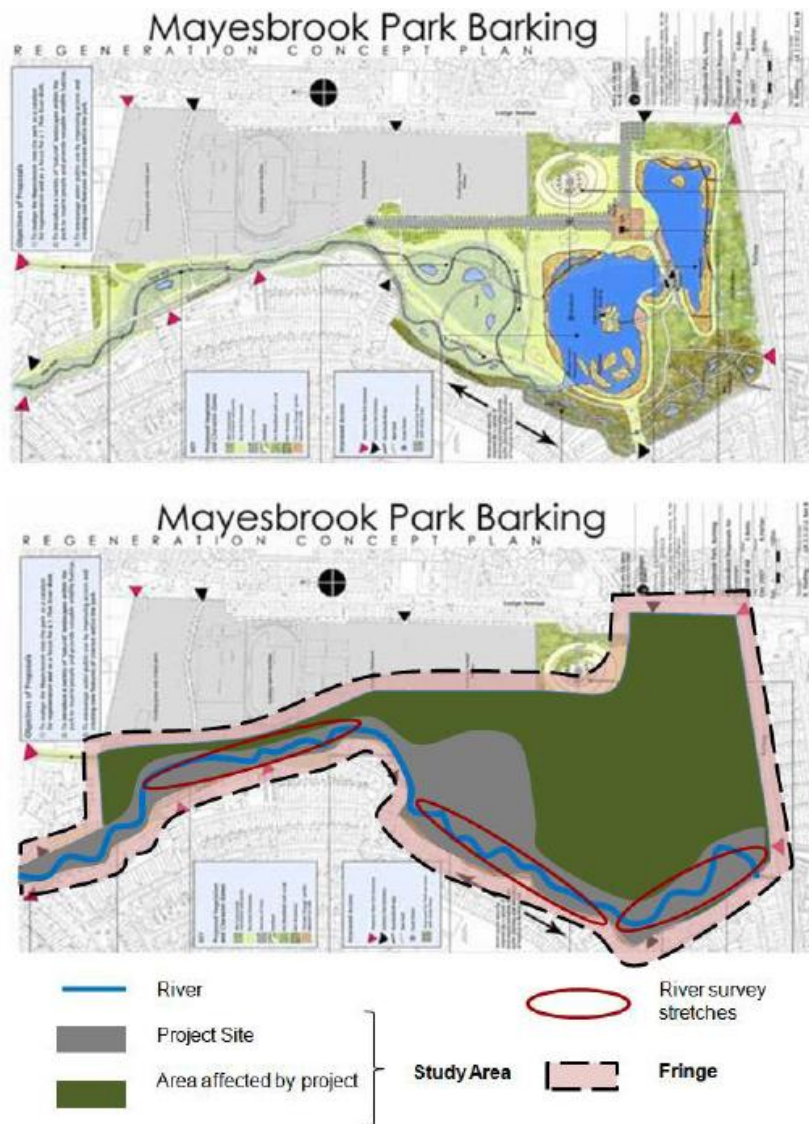

Figure 2. The upper image shows a concept plan for a river restoration scheme within a park (Mayesbrook Park, East London, UK). The lower image indicates: the river survey area (blue) with survey stretches, that is contained within the project site (grey); the study area (blue, grey and green areas), and the fringe (pink).

Structure of the ECOSTATUS Survey and Assessments

The two scales of spatial unit used in the survey are: (i) the river and its margins: ca 500 m stretches (minimum 300 m) of a single engineering type as in the URS (see www.

<http://urbanriversurvey.org/> for details) extending to ca. 5m from the bank top; and (ii) the study area assessed in relation to the left and right bank areas.

ECOSTATUS is assessed in relation four themes: Habitat and Biodiversity; Landscape; Amenity; and Heritage (Figure 3). Information assembled at the river stretch scale is mainly used to assess Habitat and Biodiversity and an important development, which builds on URS and RHS, is the inclusion of indicators of river channel dynamics, such as evidence of channel widening, narrowing or migration. Information assembled at the study area scale is mainly used to assess Landscape, Amenity and Heritage although Habitat and Biodiversity is recorded.

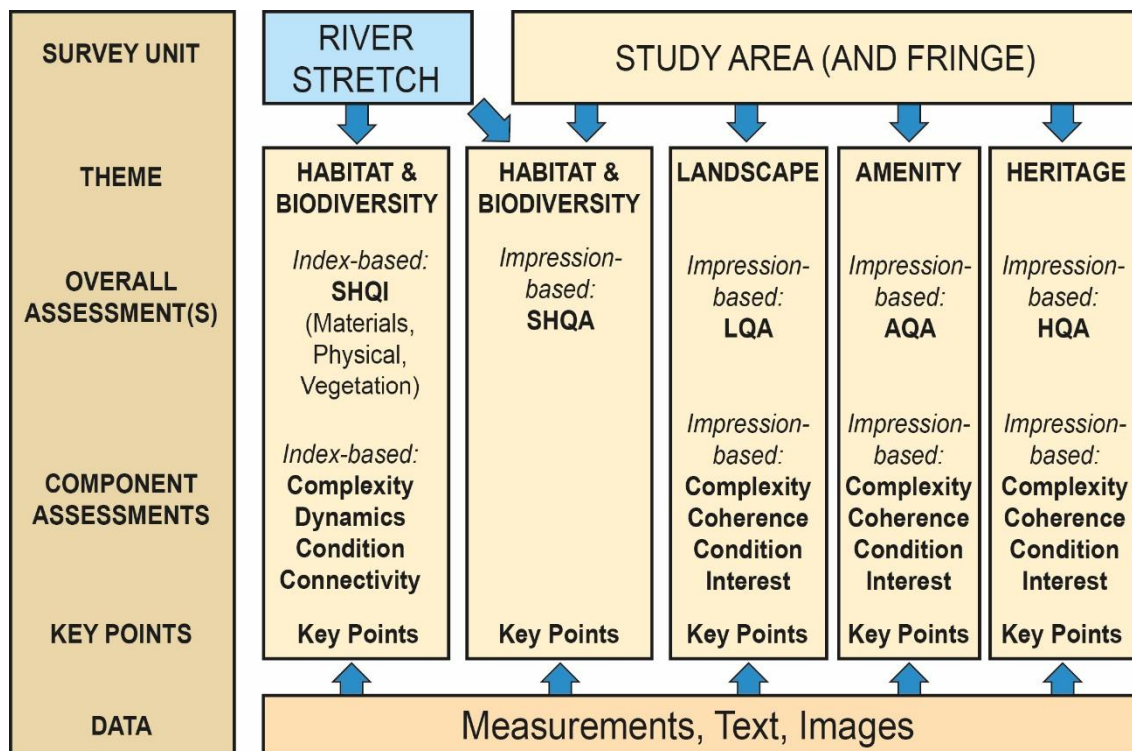

Figure 3. Conceptual flow diagram showing the structure of the ECOSTATUS Survey and Assessments.

All four themes are assessed at a high level through the surveyor's impressions of the river stretch or study area to provide four impression-based assessments: Study Area Habitat Quality Assessment (SHQA) Landscape Quality Assessment (LQA), Amenity Quality Assessment (AQA), and Heritage Quality Assessment (HQA) (Figure 3). To allow for variations in the expertise of different surveyors, the manual provides guidance to support these assessments and the surveyor is able to record his/her level of confidence (high, medium or low) in making all four assessments. In addition to the above impression-based assessments, an index-based assessment supports the evaluation of Habitat and Biodiversity through the Stretch Habitat Quality Index (SHQI).

Concluding comments

Over 40 personnel within NEAS have now received training in ECOSTATUS and surveys are being completed in relation to a variety of river-related projects. The ECOSTATUS survey has several key benefits.

- It can be undertaken following a short training course.
- It builds on the Urban River Survey and River Habitat Survey so data collected and analysed for the river survey component can be compared to existing national and international data sets.
- It is a field survey and thus triggers an important site visit and overview of the project site and study area prior to the commissioning of specialist surveys that may focus on ecology, geomorphology, or heritage, for example.
- It can be undertaken at a very early stage in the timeline of a project and the baseline data will help inform project design and development.
- It provides a tool for post-project appraisal and longer-term monitoring and SHQI values can provide an index of environmental response to any interventions that take place at a site.
- Data are securely stored, analysed, and displayed through a web-based system making information accessible between NEAS staff.

Acknowledgements

We acknowledge the financial support of NEAS in developing ECOSTATUS and we thank the many NEAS staff who contributed to the development of the methodology and the manual. We also acknowledge the enormous contribution of Lucy Shuker and Angela Davenport to the development of the URS. Finally, Ed Oliver is thanked for his work on the figures.

References

- Boitsidis, A. J., & Gurnell, A. M. (2004) *Environmental Sustainability Indicators for Urban River Management: Sustainable Management of Urban Rivers and Floodplains (SMURF) LIFE02 ENV/UK/000144*.
- Boitsidis, A. J., Gurnell, A. M., Scott, M., Petts, G. E., & Armitage, P. D. (2006) A decision support system for identifying the habitat quality and rehabilitation potential of urban rivers. *Water and Environment Journal*, 20: 1-11.
- Davenport, A. J., Gurnell, A. M., & Armitage, P. D. (2001) Classifying urban rivers. *Water Science & Technology*, 43(9): 147 - 155.
- Davenport, A. J., Gurnell, A. M., & Armitage, P. D. (2004) Habitat survey and classification of urban rivers. *River Research and Applications*, 20(6): 687-704.
- European Commission (EC) (2000). Directive 2000/60/EC of the European Parliament and of the Council of 23 October 2000 establishing a framework for community action in the field of water policy. Official Journal of the European Communities L327, pp. 1-72.
- Raven, P. J., Holmes, H. T. H., Dawson F.H., Fox P.J.A., Everard M., Fozzard, I., et al. (1998) *River Habitat Quality The physical character of rivers and streams in the UK and Isle of Man. River Habitat Survey Report No. 2*. Environment Agency (pp. 86).
- Raven, P. J., Holmes, N. T. H., Naura, M., & Dawson, F. H. (2000) Using river habitat
- Shuker, L., Gurnell, A. M. & Raco, M. (2012) Some simple tools for communicating the biophysical condition of urban rivers to support decision-making in relation to river restoration. *Urban Ecosystems*, 15: 389-408.
- survey for environmental assessment and catchment planning in the U.K. *Hydrobiologia*, 422/423: 359-367.